



---

# Functional safety

Inverter i550-Cabinet 0.25 ... 75 kW



---

## Contents

<b>Safety instructions</b> .....	<b>4</b>
Basic safety measures.....	4
Residual hazards.....	5
Application as directed.....	5
<b>Product description</b> .....	<b>6</b>
General information.....	6
Basics.....	6
Safety sensors.....	7
<b>Project planning</b> .....	<b>8</b>
Important notes.....	8
Mode of operation.....	9
Inspections.....	10
Acceptance.....	10
Periodic inspections.....	10
<b>Technical data</b> .....	<b>11</b>
Rated data.....	11
Certification.....	12
<b>Mechanical installation</b> .....	<b>13</b>
Important notes.....	13
Mounting steps for inverters 0.25 ... 2.2 kW.....	14
Mounting steps for inverters from 3 kW.....	15
<b>Electrical installation</b> .....	<b>16</b>
Important notes.....	16
Connection plan.....	17
Terminal data.....	18
<b>Declarations of Conformity</b> .....	<b>19</b>

# Safety instructions

## Basic safety measures



## Safety instructions

### Basic safety measures

Disregarding the following basic safety measures may lead to severe personal injury and damage to material assets!

The product

- must only be used as directed.
- must never be commissioned if they display signs of damage.
- must never be technically modified.
- must never be commissioned if they are not fully mounted.
- must never be operated without required covers.

Connect/disconnect all pluggable terminals only in deenergised condition.

Only remove the product from the installation in the deenergised state.

Insulation resistance tests between 24V control potential and PE: According to EN 61800–5–1, the maximum test voltage must not exceed 110 V DC.

Observe all specifications of the corresponding documentation supplied. This is the precondition for safe and trouble-free operation and for obtaining the product features specified.

The procedural notes and circuit details described in this document are only proposals. It is up to the user to check whether they can be adapted to the particular applications. Lenze does not take any responsibility for the suitability of the procedures and circuit proposals described.

The product must only be used by qualified personnel. IEC 60364 or CENELEC HD 384 define the skills of these persons:

- They are familiar with installing, mounting, commissioning, and operating the product.
- They have the corresponding qualifications for their work.
- They know and can apply all regulations for the prevention of accidents, directives, and laws applicable at the place of use.

**Please observe the specific notes in the other chapters!**

Notes used:

### **DANGER!**

This note refers to an imminent danger which, if not avoided, may result in death or serious injury.

### **WARNING!**

This note refers to a danger which, if not avoided, may result in death or serious injury.

### **CAUTION!**

This note refers to a danger which, if not avoided, may result in minor or moderate injury.

### **NOTICE**

This note refers to a danger which, if not avoided, may result in damage to property.







## Residual hazards

The user must take the residual hazards mentioned into consideration in the risk assessment for his/her machine/system.

If the above is disregarded, this can lead to severe injuries to persons and damage to material assets!

### Product

Observe the warning labels on the product!

Icon	Description
	<b>Electrostatic sensitive devices:</b> Before working on the product, the staff must ensure to be free of electrostatic charge!
	<b>Dangerous electrical voltage</b> Before working on the product, check if no voltage is applied to the power terminals! After mains disconnection, the power terminals carry the hazardous electrical voltage given on the product!
	<b>High leakage current:</b> Carry out fixed installation and PE connection in compliance with EN 61800-5-1 or EN 60204-1!
	<b>Hot surface:</b> Use personal protective equipment or wait until devices have cooled down!

### Motor

If there is a short circuit of two power transistors, a residual movement of up to 180°/number of pole pairs can occur at the motor! (For 4-pole motor: residual movement max.  $180^\circ/2 = 90^\circ$ ).

## Application as directed

The user is not allowed to change inverters that come with integrated safety technology.

The safety module must not be removed. If the safety module is defective, the inverter has to be replaced.

# Product description

## General information



---

## Product description

### General information

With increasing automation, protection of persons against hazardous movements is becoming more important. Functional safety describes the measures needed by means of electrical or electronic equipment to reduce or remove danger caused by failures.

During normal operation, safety equipment prevents people accessing hazardous areas. In certain operating modes, e.g. set-up mode, work needs to be carried out in hazardous areas. In these situations the machine operator must be protected by integrated drive and control measures.

#### Integrated safety

Integrated safety provides the conditions in the controls and drives to optimise the safety functions. Planning and installation expenditure is reduced. In comparison to the use of standard safety engineering, integrated safety increases machine functionality and availability.

The integrated safety system can be used for the protection of persons working on machines in accordance with the Machinery Directive.

The motion functions are continued to be executed by the inverter. The integrated safety system monitors the safe compliance with the limit values and provides the safe inputs. If monitored limit values are exceeded, the integrated safety system starts control functions in the inverter according to EN 60204-1 to counteract possible errors.

#### Identification of the components

Safety components and the respective terminals are always yellow.

### Basics

#### Standards

Safety regulations are confirmed by laws and other governmental guidelines and measures and the prevailing opinion among experts, e.g. by technical regulations.

The regulations and rules to be applied must be observed in accordance with the application.

#### Risk assessment

This documentation can only accentuate the need for a risk assessment. The user of the integrated safety system must read up on standards and the legal situation.

Before the launch of a machine, the manufacturer of the machine has to conduct a risk assessment according to the 2006/42/EC: Machinery Directive to determine the hazards associated with the use of the machine.

The Machinery Directive refers to three basic principles for the highest possible level of safety:

- Hazard elimination / minimisation by the construction itself.
- Taking the protective measures required against hazards that cannot be removed.
- Existing residual hazards must be documented and the user must be informed of them.

Detailed information on the risk assessment is provided in the DIN EN ISO 12100:2013-08: Safety of machinery – general principles for design – risk assessment and risk reduction. The result of the risk assessment determines the category for safety-related control systems according to EN ISO 13849-1. Safety-oriented parts of the machine control must be compliant.

#### Functional test

After the installation, the operator has to check the wiring of the safety function.



## Safety sensors

The components used must comply with the control category required for the application.

### Passive sensors

Passive sensors are 2-switching elements with contacts.

Please note the following:

- The switches must be wired according to the closed-circuit principle.
- Passive sensors are connected to the terminal strip X1 via a safety switching device.
- The connecting cables and the sensor function must be monitored.

The contacts must switch simultaneously (equivalently). Safety functions will be activated if only one channel is switched. Switching of only one channel points to faulty sensors or impermissible wiring.

Examples of passive sensors:

- Door contact switch
- Emergency stop control units

### Active sensors

Active sensors are units with 2-channel semiconductor outputs (OSSD outputs).

With the integrated safety system of this device series, test pulses  $< 1$  ms for monitoring the outputs and cables are permissible.

P/M-switching sensors switch the positive and negative cable or the signal and ground cable of a sensor signal.

Please note the following:

- The maximum permissible connection capacity of the outputs.
- Active sensors are directly connected to the terminal strip X1.
- Monitoring for short circuits must be carried out by the active sensor.

The outputs have to switch simultaneously (equivalently). Safety functions will be activated if only one channel is switched. Active triggering of only one channel points to faulty sensors or impermissible wiring.

Examples of active sensors:

- Lightgrid
- Laser scanner
- Control systems



## Project planning

### Important notes

#### **DANGER!**

Improper installation of the safety engineering system can cause an uncontrolled starting action of the drives.

Possible consequences: Death or severe injuries

- ▶ Safety engineering systems may only be installed and commissioned by qualified and skilled personnel.
- ▶ All control components (switches, relays, PLC, ...) and the control cabinet must comply with the requirements of the EN ISO 13849-1 and the EN ISO 13849-2.
- ▶ Switches, relays with at least IP54 enclosure.
- ▶ Control cabinet with at least IP54 enclosure.
- ▶ It is essential to use insulated wire end ferrules for wiring.
- ▶ All safety relevant cables outside the control cabinet must be protected, e.g. by means of a cable duct
- ▶ Ensure that no short circuits can occur according to the specifications of the EN ISO 13849-2.
- ▶ All further requirements and measures can be obtained from the EN ISO 13849-1 and the EN ISO 13849-2.
- ▶ If an external force acts upon the drive axes, additional brakes are required. Please observe that hanging loads are subject to the force of gravity!
- ▶ The user has to ensure that the inverter will only be used in its intended application within the specified environmental conditions. This is the only way to comply with the declared safety-related characteristics.

#### **DANGER!**

With the "Safe torque off" (STO) function, no "emergency stop" in terms -EN 60204-1 can be executed without additional measures. There is no isolation between the motor and inverter, no service switch or maintenance switch!

Possible consequence: death or severe injuries

- ▶ "Emergency stop" requires electrical isolation, e.g. by a central mains contactor.

#### **DANGER!**

Automatic restart if the request of the safety function is deactivated.

Possible consequences: Death or severe injuries

- ▶ You must provide external measures according to EN ISO 13849-1 which ensure that the drive only restarts after a confirmation.

#### **NOTICE**

Overvoltage

Destruction of the safety component

- ▶ The maximum voltage (maximum rated) at the safety inputs is 32 V DC. The user must make provisions to avoid that this voltage is exceeded.





### Mission time

The mission time of the used components must be complied with. When the mission time of a component has expired, the component must be replaced. Continued operation is not permitted!

The specified mission time starts at the date of manufacture. The date of manufacture is permanently stored in the component and can be read out via an object.

**The mission time for the STO safety function cannot be reset by a special proof test.**

### Mode of operation

#### Details

Safe disconnection of the drive

1. A safety sensor requests the safety function.
2. The transmission of the pulse width modulation is safely switched off by the safety unit.
3. The power drivers do not generate a rotating field anymore.
4. The "STO is not active" status in the status word changes from 1: HIGH to 0: LOW (object 0x6041, bit 15).

The motor is safely switched to torqueless operation (STO).

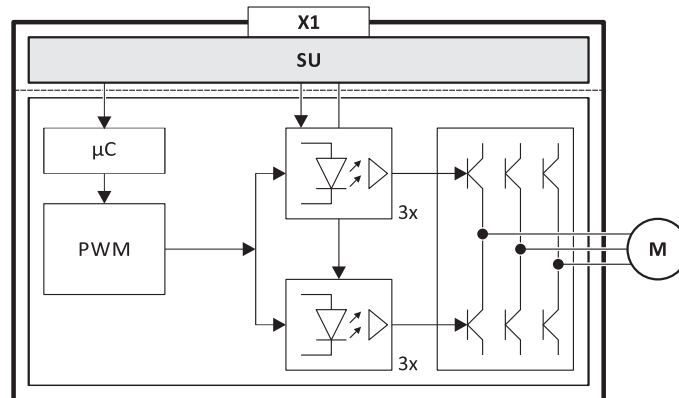

Fig. 1: Operating principle of safety unit

X1 Control terminals of the safety unit  
PWM Pulse width modulation

M Motor  
µC Microcontroller

#### Truth table

Safe input / channel		Inverter	
SIA	SIB	Device status	Approval
0	0	STO active	0
0	1		0
1	0		0
1	1	Drive enabled	1



If SIA = LOW and SIB = LOW, the internal "Safe torque off (STO) active [55]" status signal in the inverter is set to TRUE. You can use this status signal to control a "non-safe output" (e.g. the relay).

# Project planning

Inspections  
Acceptance



---

## Inspections

### Acceptance

The machine manufacturer must check and prove the operability of the safety functions used.

- The machine manufacturer must authorise a person with expertise and knowledge of the safety functions to carry out the test.
- The test result of every safety function must be documented and signed by the inspector.

A complete test comprises the following:

- Documenting the plant including the safety functions:
  - Creating an overview screen of the plant.
  - Describing the plant.
  - Describing the safety equipment.
  - Documenting the safety functions used.
  - Checking the function of the safety functions used.
- Preparing the test report:
  - Documenting the functional test.
  - Checking the parameters.
  - Signing the test report.
- Preparing the appendix with test records:
  - Protocols for the plant
  - External recording



---

If parameters of the safety functions are changed, the inspector must repeat the test and record the results in the test report.

---

### Periodic inspections

The correct sequence of the safety-oriented functions must be checked in periodic inspections. The risk analysis or applicable regulations determine the time distances between the tests.

The inspection interval should not exceed one year.



## Technical data

### Rated data



Data is valid for products delivered **before** September 1, 2016.

#### Safety-related characteristics according to IEC 61508, Part 1–7 and IEC 62061

Specification	Value	Comment
Safety Integrity Level	SIL 2	
PFH [1/h]	7.5 E-08	7.5 % of SIL 2
PFD	6.4 E-03	64 % of SIL 2 after T = 20 years
Proof test interval	20 years	Mission time

#### Safety-related characteristics according to EN ISO 13849-1

Specification	Value	Comment
Performance Level	d	
Category	2	
MTTF <sub>d</sub>	High	530 years
Diagnostic coverage DC	Low	60 %

#### Basics of the safety-related characteristics

Basics	Value	Comment
Source of failure rates	SN 29500	When no values from the component manufacturers were available.
Average max. ambient temperature	40 °C	



Data is valid for products delivered **after** September 1, 2016.

#### Safety-related characteristics according to IEC 61508, Part 1–7 and IEC 62061

Specification	Value	Comment
Safety Integrity Level	SIL 3	6.8 % of SIL 3 after T = 20 years
PFH [1/h]	1.71 E-09	1.71 % of SIL 3
PFD	1.49 E-04	14.9 % of SIL 3 after T = 20 years
Proof test interval	20 years	Mission time

#### Safety-related characteristics according to EN ISO 13849-1

Specification	Value	Comment
Performance Level	e	
Category	4	
MTTF <sub>d</sub>	High	3200 years
Diagnostic coverage DC	High	99 %

#### Basics of the safety-related characteristics

Basics	Value	Comment
Source of failure rates	SN 29500	When no values from the component manufacturers were available.
Average max. ambient temperature	40 °C	



---

### Certification

The certification of the integrated safety is based on these test fundamentals:

- EN ISO 13849-1: Safety of machinery – safety-related parts of control systems – Part 1
- EN ISO 13849-2: Safety of machinery – safety-related parts of control systems – Part 2
- EN 60204-1: Safety of machinery – electrical equipment of machines – Part 1
- IEC 61508, Part 1-7: Functional safety of safety-related electrical/electronic/programmable electronic systems
- EN 61800-3: Electric variable-speed drives – Part 3: EMC requirements including specific test procedures
- EN 61800-5-1: Adjustable speed electrical power drive systems – Part 5-1: Safety requirements – electrical, thermal and energy
- EN 61800-5-2: Adjustable speed electrical power drive systems – Part 5-2: Safety requirements – functional safety
- IEC 62061: Safety of machinery – functional safety of safety-related electrical/electronic/programmable electronic systems



Declarations of Conformity and certificates can be found on the internet at <http://www.Lenze.com>

---



## Mechanical installation

### Important notes

#### **i** NOTICE

When the blanking cover is removed, parts may fall into the inverter.

Possible consequence: Failures.

- ▶ Mount the safety module as shown. This ensures that no parts can fall into the inverter.
- 



After being mounted, the safety module cannot be removed anymore!

---

# Mechanical installation

Mounting steps for inverters 0.25 ... 2.2 kW



## Mounting steps for inverters 0.25 ... 2.2 kW

You need:

- Slotted screwdriver size 3

1. Put the inverter on the edge of a worktop.

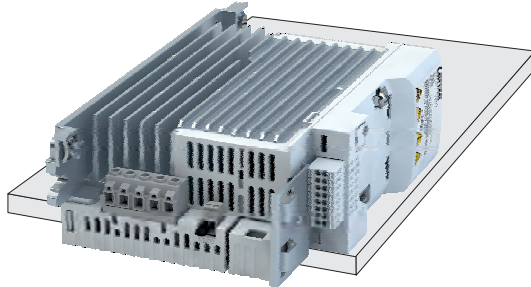

2. Insert the screwdriver into the cut-out.

3. Break out the blanking cover with a downward rotation.

4. Dispose of the blanking cover.

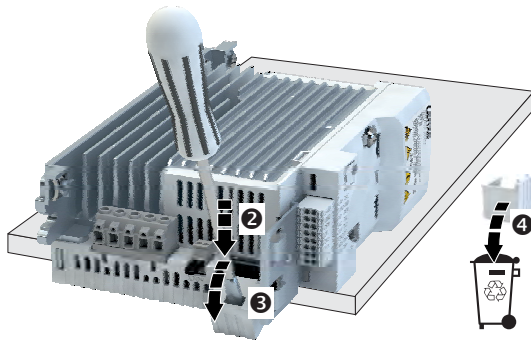

5. Insert the safety module into the plug connection.

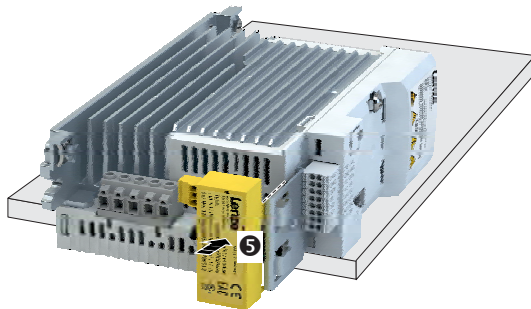

6. Press until the safety module snaps into the holders.

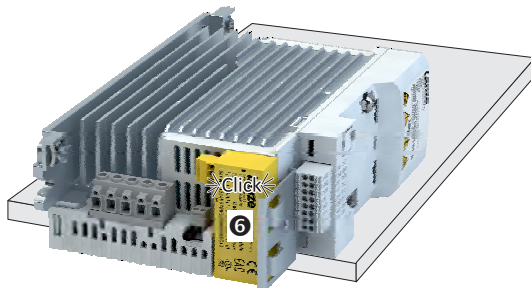

The safety module is mounted.



## Mechanical installation

Mounting steps for inverters from 3 kW

### Mounting steps for inverters from 3 kW

You need:

- Slotted screwdriver, size 3
1. Insert screwdriver into recess.
  2. Break out the blanking cover by turning the screwdriver to the left.
  3. Dispose of the blanking cover.



4. Insert the safety module into the plug connection.
5. Press it until the safety module snaps into the holders.

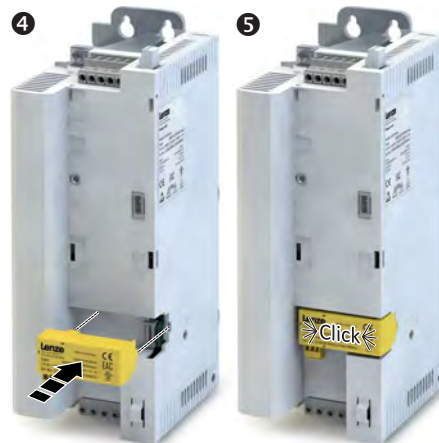

The safety module is mounted.

# Electrical installation

## Important notes



---

## Electrical installation

### Important notes

Please note the following:

- The input channels comply with the IEC 61131–2, type 1 standard.
- The safe inputs are electrically isolated.
- The safe inputs are provided with polarity reversal protection.
- Short circuits are not monitored.
- Test pulses  $\leq 1$  ms are permissible.
- P/M-switched input signals are permissible.
- Voltage supply 24 V DC only through safely separated power supply unit (SELV/PELV).
- Active sensors are directly connected to the terminal strip X1.
- Passive sensors are connected to terminal strip X1 via a safety switching device. The switching device must comply with the required control category of the application.





Connection plan

Passive sensors

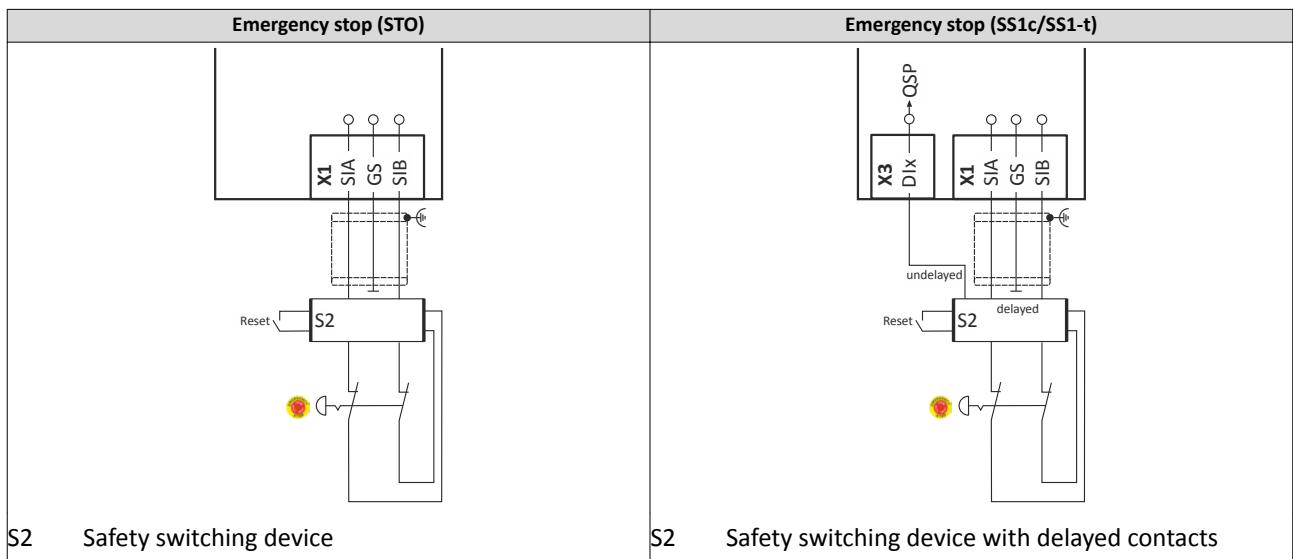
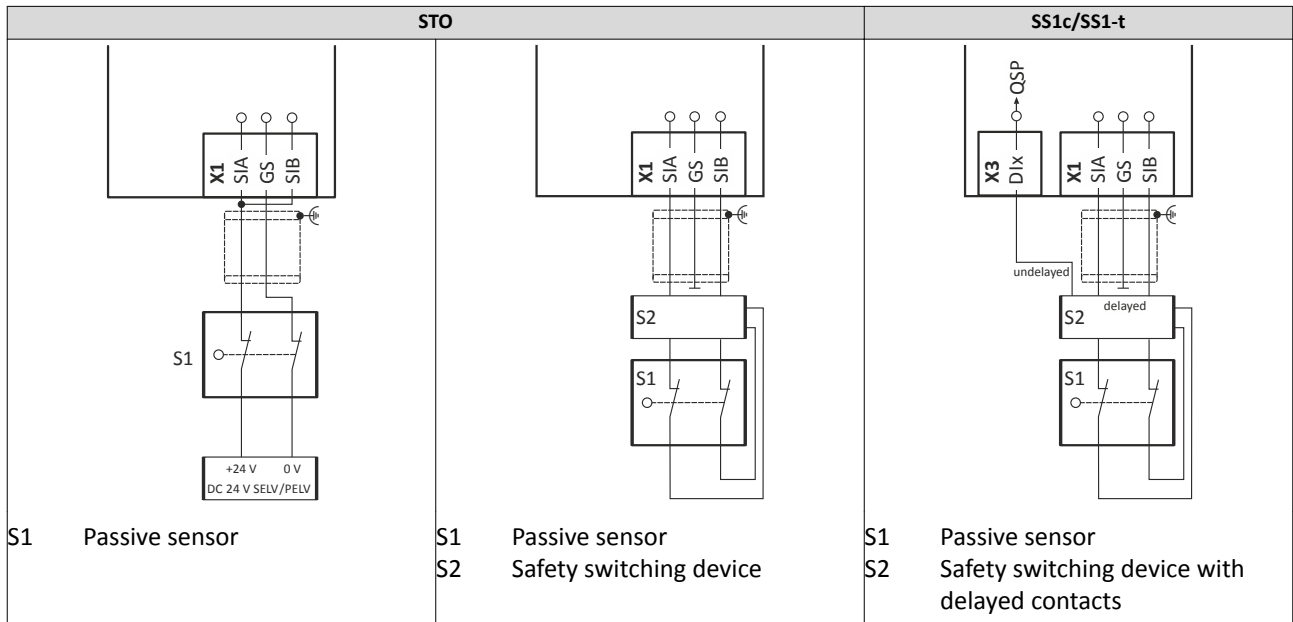

Active sensors

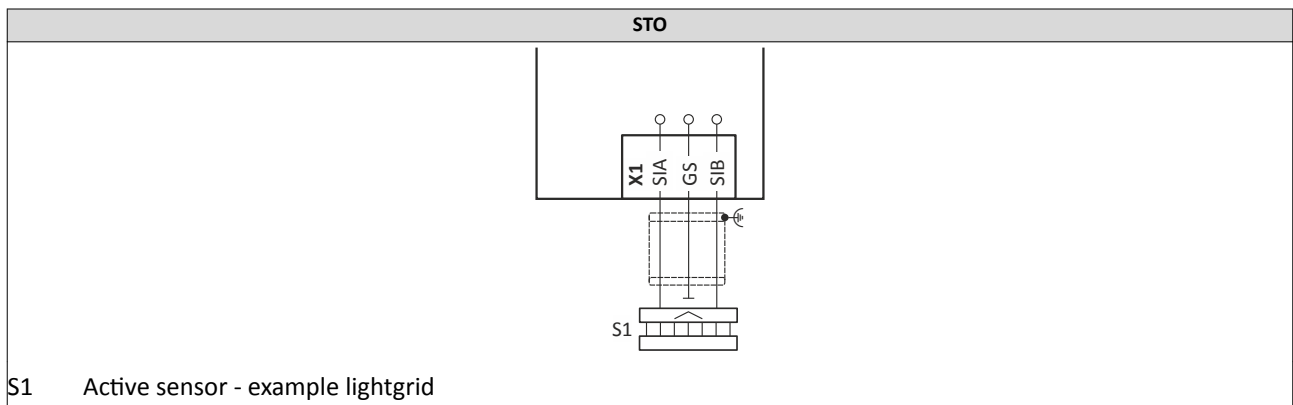

# Electrical installation

## Terminal data



### Terminal data

X1	Specification	Unit	min.	typ.	max.
SIA, SIB	LOW signal	V	-3	0	+5
	HIGH signal	V	+15	+24	+30
	Running time	ms		3	
	Input current SIA	mA		10	14
	Input current SIB	mA		7	12
	Input peak current	mA		100	
	Tolerated test pulse	ms			1
	Switch-off time	ms		50	
	Permissible distance of the test pulses	ms	10		
GS	Reference potential for SIA and SIB				



## Declarations of Conformity



---

Data is valid for products delivered **before** September 1, 2016.

---



# Schmidhauser

2338528.04

## EG-Konformitätserklärung

## EC Declaration of Conformity

**Lenze Schmidhauser AG, Obere Neustrasse 1, 8590 Romanshorn SWITZERLAND**

erklärt in alleiniger Verantwortung die Übereinstimmung der Produkte

declares under sole responsibility compliance of the products:

Antriebsregler der Baureihen:

Controllers of the series:

**ISDAE**xxxx1001xxxxx (Power Units) &  
**ISMASAO**xxxxxxxx (Safety Module) **valid for Hardware Version VC**  
 mit der

with the

### Maschinenrichtlinie

2006/42/EG Anhang IX und VIII

Angewandte harmonisierte Normen:

### Machinery Directive

2006/42/EC Annex IX und VIII

Applied harmonized standards:

Sicherer Halt	Stopp Kategorie 0	<b>EN 60204-1</b> + A1 + AC	:2006 :2009 :2010	Stop category 0	Safe torque off
	Kategorie 2 Performance Level (PL): PL d	<b>EN ISO 13849-1</b> + AC	:2008 :2009	Category 2 Performance Level (PL): PL d	
Sicherheitsfunktionen siehe Betriebsanleitung.	SIL 2	<b>EN 61508 1-7</b> <b>EN 62061</b> + AC + A1 <b>EN 61800-5-2</b> <b>EN 61800-5-1</b> <b>EN 61800-3</b> + A1	:2010 :2005 :2010 :2013 :2007 :2007 :2004 :2012	SIL 2	safety functions see manual.



### Konformitätsbewertung



Benannte Stelle

Zertifikate

Gültigkeit

Die Sicherheitshinweise der Betriebsanleitung sind zu beachten.

Die Produkte sind bestimmt zum Einbau in Maschinen. Die Inbetriebnahme ist solange untersagt bis festgestellt wurde, dass die Maschine, in welche diese Produkte eingebaut werden sollen, den Bestimmungen der o.g. EG-Richtlinie entsprechen.

Ort / Datum  
Place / date

Romanshorn 29.06.2016

Geschäftsführer  
General Manager

*D. Cesaretti*  
D. Cesaretti

### Conformity assessment

notified body

Self-assessment by Lenze

certificates

-

Date of expiry

-

The safety instructions of the manual are to be considered.

These products are intended for installation in machines. Operation is prohibited until it has been determined that the machines in which these products are to be installed, conforms to the above mentioned EC Directive.

Dokumentationsverantwortlicher  
Responsible for documentation

*T. Wedemeyer*  
i.A. T. Wedemeyer



# Schmidhauser

2338528.04

## Déclaration de conformité CE

## Dichiarazione di conformità CE

Lenze Schmidhauser AG, Obere Neustrasse 1, 8590 Romanshorn SWITZERLAND

Déclare, sous sa seule responsabilité, que les produits

dichiara sotto la propria esclusiva responsabilità la conformità dei seguenti prodotti

Variateurs de vitesse des séries :

Unità di controllo delle serie:

ISDAExxxx1001xxxxx (Power Units) &  
ISMASAOxxxxxxx (Safety Module) **valid for Hardware Version VC**  
respectent la

alla

### Directive Machines

2006/42/CE Annexes IX et VIII

Normes harmonisées appliquées :

### Direttiva macchine

2006/42/CE Allegato IX e VIII

Standard armonizzati applicati:

Arrêt sécurisé	Catégorie d'arrêt 0	EN 60204-1 + A1 + AC
	Catégorie 2	EN ISO 13849-1 + AC
Fonctions de sécurité : voir manuel d'utilisation.	Niveau de performance(PL): PL d	EN 61508 1-7
	SIL 2	EN 62061 + AC + A1
		EN 61800-5-2
		EN 61800-5-1
		EN 61800-3 + A1

:2006	Categoria di stop 0	Arresto sicuro
:2009		
:2010		
:2008	Categoria 2	
:2009		
	Livello di prestazioni (PL): PL d	
:2010		
:2005	SIL 2	safety functions see manual.
:2010		
:2013		
:2007		
:2007		
:2004		
:2012		



### Évaluation de conformité

### Valutazione della conformità



Organisme notifié

Ente notificato

Self-assessment by Lenze

Certificats

Certificati

-

Date d'expiration

Validità

-

Respecter impérativement les consignes de sécurité contenues dans le manuel d'utilisation.

Osservare assolutamente le informazioni sulla sicurezza riportate nelle istruzioni operative.

Ces produits sont destinés à être installés au sein de machines. Leur mise en service est interdite tant qu'il n'a pas été attesté que la machine destinée à les accueillir respecte les dispositions de la directive CE susmentionnée.

I prodotti elencati sono destinati all'installazione su macchine e non possono essere messi in funzione fintanto che non sia stata verificata la conformità delle macchine su cui dovranno essere installati alla suddetta direttiva CE.

Lieu / date  
Luogo / data

Geschäftsführer  
General Manager

Responsable de documentation  
Responsabile della documentazione

Romanshorn 29.06.2016

D. Cesaretti

I.A. T. Wedemeyer



# Schmidhauser

2338528.04

## Declaración de conformidad CE

## Declaração de Conformidade CE

**Lenze Schmidhauser AG, Obere Neustrasse 1, 8590 Romanshorn SWITZERLAND**

declara bajo su propia responsabilidad, que los productos

declara, sob sua exclusiva responsabilidade, a conformidade dos produtos

Controladores de las series:

Regulador de accionamento das séries de modelos:

**ISDAExxxx1001xxxxx (Power Units) & ISMASA0xxxxxxxx (Safety Module) valid for Hardware Version VC**

cumplen con la

com a

### Directiva de Máquinas

2006/42/CE Anexo IX y VIII

### Directiva de Máquinas

2006/42/CE Anexo IX e VIII

#### Normas armonizadas aplicables:

#### Normas harmonizadas aplicadas:

Paro seguro	Categoría de paro 0	EN 60204-1 + A1 + AC	:2006 :2009 :2010	Paragem categoria 0	Paragem segura
	Categoría 2	EN ISO 13849-1 + AC	:2008 :2009	Categoría 2	
	Nivel de rendimiento (PL): PL d			Nivel de performance (PL): PL d	
Las funciones de seguridad se encuentran en el manual de instrucciones.	SIL 2	EN 61508 1-7 EN 62061 + AC + A1 EN 61800-5-2 EN 61800-5-1 EN 61800-3 + A1	:2010 :2005 :2010 :2013 :2007 :2007 :2004 :2012	SIL 2	safety functions see manual.



### Evaluación de conformidad

### Avaliação da conformidade



Entidad notificada

Organismo notificado

Self-assessment by Lenze

Certificados

Certificados

-

Validez

Validade

-

Deben tenerse en cuenta las instrucciones de seguridad del manual.

Devem ser observadas as instruções de segurança do manual de operação.

Los productos están diseñados para su instalación en máquinas. Está prohibida la puesta en marcha hasta que se pueda determinar que la máquina en la que se instale éste producto cumpla con las directivas anteriormente indicadas.

Os produtos são destinados à incorporação em máquinas. A colocação em serviço permanece proibida até que seja constatado que a máquina, na qual estes produtos devem ser incorporados, corresponde às disposições da Directiva de Máquinas CE acima citada.

Lugar / Fecha  
Local / Data

Romanshorn 29.06.2016

Geschäftsführer  
General Manager

*D. Cesaretti*  
D. Cesaretti

Responsable de la documentación  
Responsável pela documentação

*I. T. Wedemeyer*  
I.A. T. Wedemeyer



## Declarations of Conformity



---

Data is valid for products delivered **after** September 1, 2016.

---



# Schmidhauser

2353891.02

## EG-Konformitätserklärung

## EC Declaration of Conformity

**Lenze Schmidhauser AG, Obere Neustrasse 1, 8590 Romanshorn SWITZERLAND**

erklärt in alleiniger Verantwortung die Übereinstimmung der Produkte

declares under sole responsibility compliance of the products:

Antriebsregler der Baureihen:

Controllers of the series:

ISDAExxxx1001xxxxx (Power Units) &  
ISMA5A0xxxxxxx (Safety Module) valid from HW-Version 2A  
mit der

with the

**Maschinenrichtlinie**  
2006/42/EG Anhang IX und VIII

**Machinery Directive**  
2006/42/EC Annex IX und VIII

Angewandte harmonisierte Normen:

Applied harmonized standards:

Sicherer Halt	Stopp Kategorie 0	EN 60204-1 + A1 + AC	:2006 :2009 :2010	Stop category 0	Safe torque off
	Kategorie 4 Performance Level (PL): PL e	EN ISO 13849-1 + AC	:2008 :2009	Category 4 Performance Level (PL): PL e	
		EN 61508 1-7	:2010		
Sicherheitsfunktionen siehe Betriebsanleitung.	SIL 3	EN 62061 + AC + A1	:2005 :2010 :2013	SIL 3	safety functions see manual.
		EN 61800-5-2	:2007		
		EN 61800-5-1	:2007		
		EN 61800-3 + A1	:2004 :2012		



### Konformitätsbewertung

### Conformity assessment

**CE 0035**  
Benannte Stelle  
Zertifikate  
Gültigkeit

notified body  
certificates  
Date of expiry  
TÜV Rheinland Industrie Service GmbH  
Alboinstrasse 56  
12103 Berlin / Germany  
01/205/5455.00/15  
15.06.2020

Die Sicherheitshinweise der Betriebsanleitung sind zu beachten.

The safety instructions of the manual are to be considered.

Die Produkte sind bestimmt zum Einbau in Maschinen. Die Inbetriebnahme ist solange untersagt bis festgestellt wurde, dass die Maschine, in welche diese Produkte eingebaut werden sollen, den Bestimmungen der o.g. EG-Richtlinie entsprechen.

These products are intended for installation in machines. Operation is prohibited until it has been determined that the machines in which these products are to be installed, conforms to the above mentioned EC Directive.

Ort / Datum  
Place / date  
Romanshorn 29.06.2016

Geschäftsführer  
General Manager  
*D. Cesaretti*  
D. Cesaretti

Dokumentationsverantwortlicher  
Responsible for documentation  
*T. Wedemeyer*  
I.A. T. Wedemeyer





# Schmidhauser

2353891.02

## Déclaration de conformité CE

## Dichiarazione di conformità CE

**Lenze Schmidhauser AG, Obere Neustrasse 1, 8590 Romanshorn SWITZERLAND**

Déclare, sous sa seule responsabilité, que les produits

dichiara sotto la propria esclusiva responsabilità la conformità dei seguenti prodotti

Variateurs de vitesse des séries :

Unità di controllo delle serie:

ISDAExxxx1001xxxxx (Power Units) &  
ISMASA0xxxxxxx (Safety Module) valid from HW-Version 2A  
respectent la

alla

### Directive Machines

### Direttiva macchine

2006/42/CE Annexes IX et VIII

2006/42/CE Allegato IX e VIII

Normes harmonisées appliquées :

Standard armonizzati applicati:

Arrêt sécurisé	Catégorie d'arrêt 0	EN 60204-1 + A1 + AC	:2006 :2009 :2010	Categoria di stop 0	Arresto sicuro
	Catégorie 4	EN ISO 13849-1 + AC	:2008 :2009	Categoria 4	
	Niveau de performance(PL): PL e	EN 61508 1-7 EN 62061 + AC + A1	:2010 :2005 :2010 :2013	Niveau di prestazioni (PL): PL e	
Fonctions de sécurité : voir manuel d'utilisation.	SIL 3	EN 61800-5-2 EN 61800-5-1 EN 61800-3 + A1	:2007 :2007 :2004 :2012	SIL 3	safety functions see manual.



### Évaluation de conformité

### Valutazione della conformità



Organisme notifié

Ente notificato

TÜV Rheinland Industrie Service GmbH  
Alboinstrasse 56  
12103 Berlin / Germany

Certificats

Certificati

01/205/5455.00/15

Date d'expiration

Validità

15.06.2020

Respecter impérativement les consignes de sécurité contenues dans le manuel d'utilisation.

Osservare assolutamente le informazioni sulla sicurezza riportate nelle istruzioni operative.

Ces produits sont destinés à être installés au sein de machines. Leur mise en service est interdite tant qu'il n'a pas été attesté que la machine destinée à les accueillir respecte les dispositions de la directive CE susmentionnée.

I prodotti elencati sono destinati all'installazione su macchine e non possono essere messi in funzione fintanto che non sia stata verificata la conformità delle macchine su cui dovranno essere installati alla suddetta direttiva CE.

Lieu / date  
Luogo / data

Geschäftsführer  
General Manager

Responsable de documentation  
Responsabile della documentazione

Romanshorn 29.06.2016

D. Cesaretti

I.A. T. Wedemeyer



## Schmidhauser

2353891.02

### Declaración de conformidad CE

### Declaração de Conformidade CE

**Lenze Schmidhauser AG, Obere Neustrasse 1, 8590 Romanshorn SWITZERLAND**

declara bajo su propia responsabilidad, que los productos

declara, sob sua exclusiva responsabilidade, a conformidade dos produtos

Controladores de las series:

Regulador de accionamento das séries de modelos:

ISDAExxxx1001xxxxx (Power Units) &  
ISMASA0xxxxxxx (Safety Module) valid from HW-Version 2A  
cumplen con la

com a

**Directiva de Máquinas**  
2006/42/CE Anexo IX y VIII

**Directiva de Máquinas**  
2006/42/CE Anexo IX e VIII

**Normas armonizadas aplicables:**

**Normas harmonizadas aplicadas:**

Paro seguro	Categoría de paro 0	EN 60204-1 + A1 + AC	:2006 :2009 :2010	Paragem categoria 0	Paragem segura
	Categoría 4	EN ISO 13849-1 + AC	:2008 :2009		
Las funciones de seguridad se encuentran en el manual de Instrucciones.	Nivel de rendimiento (PL): PL e	EN 61508 1-7 EN 62061 + AC + A1	:2010 :2005 :2010 :2013	Nível de performance (PL): PL e	SIL 3 safety functions see manual.
	SIL 3	EN 61800-5-2	:2007		
		EN 61800-5-1 EN 61800-3 + A1	:2007 :2004 :2012		



#### Evaluación de conformidad

#### Avaliação da conformidade



Entidad notificada

Certificados

Validez

Organismo notificado

Certificados

Validade

TÜV Rheinland Industrie Service GmbH  
Alboinstrasse 56  
12103 Berlin / Germany

01/205/5455.00/15

15.06.2020

Deben tenerse en cuenta las instrucciones de seguridad del manual.

Devem ser observadas as instruções de segurança do manual de operação.

Los productos están diseñados para su instalación en máquinas. Está prohibida la puesta en marcha hasta que se pueda determinar que la máquina en la que se instale éste producto cumpla con las directivas anteriormente indicadas.

Os produtos são destinados à incorporação em máquinas. A colocação em serviço permanece proibida até que seja constatado que a máquina, na qual estes produtos devem ser incorporados, corresponde às disposições da Directiva de Máquinas CE acima citada.

Lugar / Fecha  
Local / Data

Romanshorn 29.06.2016

Geschäftsführer  
General Manager

*D. Cesaretti*  
D. Cesaretti

Responsable de la documentación  
Responsável pela documentação

*T. Wedemeyer*  
i.A. T. Wedemeyer



🏢 Lenze Drives GmbH  
Postfach 10 13 52, D-31763 Hameln  
Breslauer Straße 3, D-32699 Extertal  
Germany  
HR Lemgo B 6478  
☎ +49 5154 82-0  
📠 +49 5154 82-2800  
@ lenze@lenze.com  
🌐 www.lenze.com

✂ Lenze Service GmbH  
Breslauer Straße 3, D-32699 Extertal  
Germany  
☎ 0080002446877 (24 h helpline)  
📠 +49 5154 82-1112  
@ service.de@lenze.com

TD 20160831

