



Inverter

Inverter i510 Cabinet 0.25 kW ... 15 kW

Contents

About this document	7
Document description	7
Further documents.....	7
Notations and conventions.....	8
Product information	9
Product description	9
Identification of the products.....	10
Features.....	13
The modular system	16
The concept	16
Topologies / network.....	16
Ways of commissioning.....	17
Functions.....	18
Overview.....	18
Motor control types	18
Features.....	19
Motor setting range.....	19
Information on project planning	21
Project planning process.....	21
Dimensioning	21
Operation in motor and generator mode.....	23
Overcurrent operation.....	24
Safety instructions	26
Basic safety instructions	26
Application as directed.....	27
Handling.....	28
Residual hazards.....	29
Control cabinet structure.....	31
Arrangement of components.....	31
Cables	32
Earthing concept	32
EMC-compliant installation	33
Information on mechanical installation	35
Important notes.....	35
Preparation.....	35

Contents

Information on electrical installation	36
Important notes.....	36
Preparation.....	38
Mains connection	39
1-phase mains connection 230/240 V.....	40
3-phase mains connection 230/240 V.....	42
3-phase mains connection 230/240 V "Light Duty"	43
3-phase mains connection 400 V.....	44
3-phase mains connection 400 V "Light Duty"	44
3-phase mains connection 480 V.....	45
3-phase mains connection 480 V "Light Duty"	45
Motor connection.....	46
Connection to the IT system.....	47
Control connections.....	48
Networks.....	49
CANopen/Modbus.....	49
BACnet.....	49

Technical data	50
Standards and operating conditions.....	50
Conformities/approvals.....	50
Protection of persons and device protection.....	50
EMC data.....	50
Motor connection.....	51
Environmental conditions.....	51
Electrical supply conditions.....	51
1-phase mains connection 230/240 V.....	52
Rated data.....	53
Fusing data.....	57
Terminal data.....	63
Mains chokes.....	66
RFI filters / Mains filters.....	67
3-phase mains connection 230/240 V.....	69
Rated data.....	70
Fusing data.....	73
Terminal data.....	78
Mains chokes.....	80
3-phase mains connection 230/240 V "Light Duty".....	81
Rated data.....	81
Fusing data.....	83
Terminal data.....	85
Mains chokes.....	85
3-phase mains connection 400 V.....	86
Rated data.....	86
Fusing data.....	89
Terminal data.....	94
Mains chokes.....	96
RFI filters / Mains filters.....	97
Sine filter.....	98
3-phase mains connection 400 V "Light Duty".....	99
Rated data.....	99
Fusing data.....	101
Terminal data.....	104
Mains chokes.....	105
RFI filters / Mains filters.....	106
3-phase mains connection 480 V.....	107
Rated data.....	107
Fusing data.....	110
Terminal data.....	115
Mains chokes.....	117
RFI filters / Mains filters.....	118
3-phase mains connection 480 V "Light Duty".....	120
Rated data.....	120
Fusing data.....	122
Terminal data.....	125
Mains chokes.....	126
RFI filters / Mains filters.....	127

Contents

Dimensions.....	128
Product extensions.....	133
Overview.....	133
I/O extensions.....	134
Basic I/Os.....	134
Data of control connections.....	135
Further control connections.....	137
Relay output.....	137
Networks.....	138
CANopen.....	138
CANopen/Modbus.....	138
Modbus RTU.....	139
Accessories.....	140
Overview.....	140
Operation and diagnostics.....	141
Keypad.....	141
External keypad.....	141
USB module.....	142
WLAN module.....	143
Blanking cover.....	145
Setpoint potentiometer.....	145
Memory modules.....	145
Memory module copier.....	146
Mains chokes.....	146
RFI filters / Mains filters.....	147
Sine filter.....	148
Brake switches.....	148
Mounting.....	149
Shield mounting kit.....	149
Terminal strips.....	150
Purchase order.....	151
Notes on ordering.....	151
Order code.....	152
Appendix.....	153
UL fuses (High SCCR).....	153
Good to know.....	155
Approvals/directives.....	155
Operating modes of the motor.....	156
Motor control types.....	157
Switching frequencies.....	159
Enclosures.....	160



About this document

The information in this document represents the following version:

Product	Hardware data version	Date
i510	V0009	2018-10-04

Document description

This document is aimed at all persons who want to project inverters with the described products.

This documentation assists you with the configuration and selection of your product. It also contains information on preparations for mechanical and electrical installation, on product expansions, and on accessories.

Further documents

For certain tasks, information is available in further documents.

Document	Contents/topics
Configuration document	Basic information on project planning and ordering the product
Commissioning document	Fundamental information for the installation and commissioning of the product
"Functional safety" configuration document	Basic information on configuring "functional safety" of the product
Quick Reference Card	Brief information about operation and device properties of the product

For certain tasks, information is available in other forms.

Form	Contents/topics
Engineering Tools	For commissioning
AKB articles	Application Knowledge Base with additional technical information for users
CAD data	Exports in different formats
EPLAN macros	Project planning, documentation and management of projects for P8. • Data reference via Lenze or EPLAN data portal



Information and tools with regard to the Lenze products can be found on the Internet:

<http://www.lenze.com> → Download





About this document

Notations and conventions



Notations and conventions

This document uses the following conventions to distinguish different types of information:

Numeric notation			
	Decimal separator	Point	The decimal point is always used. Example: 1 234.56
Warning			
	UL warning	UL	Are used in English and French.
	UR warning	UR	
Text			
	Engineering tools	» «	Software Example: »Engineer«, »EASY Starter«
Icons			
	Page reference		Reference to another page with additional information Example:  16 = see page 16
	Documentation reference		Reference to another documentation with additional information Example:  EDKxxx = see documentation EDKxxx

Layout of the safety instructions

DANGER!

Indicates an extremely hazardous situation. Failure to comply with this instruction will result in severe irreparable injury and even death.

WARNING!

Indicates an extremely hazardous situation. Failure to comply with this instruction may result in severe irreparable injury and even death.

CAUTION!

Indicates a hazardous situation. Failure to comply with this instruction may result in slight to medium injury.

NOTICE

Indicates a material hazard. Failure to comply with this instruction may result in material damage.



Product information

Product description

i500 is the new inverter series - a streamlined design, scalable functionality and exceptional user-friendliness.

I500 is a high-quality inverter that already conforms to future standard in accordance with the EN 50598-2 efficiency classes (IE). Overall, this provides a reliable and future-proof drive for a wide range of machine applications.

The i510

This chapter provides the complete scope of the inverter i510. This version is suitable for simple applications in inverter-operated drives. Basically, the device has the following features:

- All typical motor control types of modern inverters.
- Stroke and continuous operation of the motor according to common operating modes.
- Networking options via CANopen/Modbus.
- Extensively integrated functions.

Highlights

- Compact size
 - Only 60 mm wide and 130 mm deep
- Can be directly connected without external cooling
- Innovative interaction options enable better set-up times than ever.

Application ranges

- Pumps and fans
- Conveying and travelling drives
- Forming and tool drives

Product information

Identification of the products



Identification of the products

When the technical data of the different versions was listed, the product name was entered because it is easier to read than the individual product code of the product. The product name is also used for categorising the accessories. The assignment of product name and order code can be found in the Order chapter.

The product name contains the power in kW, the mains voltage class 120 V, 230 V or 400 V and the number of phases.

In the product name, the power information always refers to the "Heavy Duty" load characteristic.

The 1/3-phase inverters are marked at the end with "-2".

"C" marks the "Cabinet" version = inverter for the installation into the control cabinet.

Inverter series	Type	Rated power		Rated mains voltage	Number of phases	Inverter
		kW	V			
Inverter i510 Cabinet	C	0.25	230	1	i510-C0.25/230-1	
				1/3	i510-C0.25/230-2	
		0.37		1	i510-C0.37/230-1	
				1/3	i510-C0.37/230-2	
		0.55		1	i510-C0.55/230-1	
				1/3	i510-C0.55/230-2	
		0.75		1	i510-C0.75/230-1	
				1/3	i510-C0.75/230-2	
		1.1		1	i510-C1.1/230-1	
				1/3	i510-C1.1/230-2	
		1.5		1	i510-C1.5/230-1	
				1/3	i510-C1.5/230-2	
		2.2		1	i510-C2.2/230-1	
				1/3	i510-C2.2/230-2	

Inverter series	Type	Rated power		Rated mains voltage	Number of phases	Inverter		
		Light duty	Heavy Duty					
		kW	kW					
Inverter i510 Cabinet	C	-	240	1/3	i510-C0.25/230-2			
					i510-C0.37/230-2			
					i510-C0.55/230-2			
					i510-C0.75/230-2			
					i510-C1.1/230-2			
					i510-C1.5/230-2			
					i510-C2.2/230-2			
					5.5	4	3	i510-C4.0/230-3
		7.5		5.5				i510-C5.5/230-3



Product information

Identification of the products

Inverter series	Type	Rated power		Rated mains voltage	Number of phases	Inverter
		Light duty	Heavy Duty			
		kW	kW			
Inverter i510 Cabinet	C	-	0.37	400	3	i510-C0.37/400-3
			0.55			i510-C0.55/400-3
			0.75			i510-C0.75/400-3
			1.1			i510-C1.1/400-3
			1.5			i510-C1.5/400-3
			2.2			i510-C2.2/400-3
		4	3			i510-C3.0/400-3
		5.5	4			i510-C4.0/400-3
		7.5	5.5			i510-C5.5/400-3
		11	7.5			i510-C7.5/400-3
		15	11			i510-C11/400-3

Inverter series	Type	Rated power		Rated mains voltage	Number of phases	Inverter
		Light duty	Heavy Duty			
		kW	kW			
Inverter i510 Cabinet	C	-	0.37	480	3	i510-C0.37/400-3
			0.55			i510-C0.55/400-3
			0.75			i510-C0.75/400-3
			1.1			i510-C1.1/400-3
			1.5			i510-C1.5/400-3
			2.2			i510-C2.2/400-3
		4	3			i510-C3.0/400-3
		5.5	4			i510-C4.0/400-3
		7.5	5.5			i510-C5.5/400-3
		11	7.5			i510-C7.5/400-3
		15	11			i510-C11/400-3

Product information

Identification of the products



Product code

		I	5	1	A	E	□□	□	1	0	□	□	□□□□
Product type	Inverter	I											
Product family	i500		5										
Product	i510			1									
Product generation	Generation 1				A								
Mounting type	Control cabinet mounting					E							
Rated power [W] (Examples)	0.25 kW						125						
	0.55 kW						155						
	2.2 kW						222						
Mains voltage and connection type	1/N/PE AC 230/240 V							B					
	1/N/PE AC 230/240 V							D					
	2/N/PE AC 230/240 V							C					
	3/PE AC 230/240 V							F					
	3/PE AC 400 V 3/PE 480 V AC												
Motor connections	Single axis							1					
Integrated functional safety	Without							0					
Enclosure	IP20								0				
	IP20, coated								V				
Interference suppression	Without								0				
	Integrated RFI filter								1				
Design types	Global type 50 Hz									0			
	Local type 60 Hz									1			
	Basic I/O without network										0	000S	
	Basic I/O with CANopen/Modbus											001S	

Example:

Product code	Meaning
I51AE215F10010001S	Inverter i510 Cabinet, 1.5 kW, three-phase, 400 V/480 V IP20, integrated RFI filter, 50-Hz version Basic I/O with CANopen/Modbus network



Features

The following figures give an overview of the elements and connections on the devices. Position, size and appearance of elements and connections may vary depending on the capacity and size of the equipment.

Some equipment may be optional.

Example of 0.25 kW ... 2.2 kW

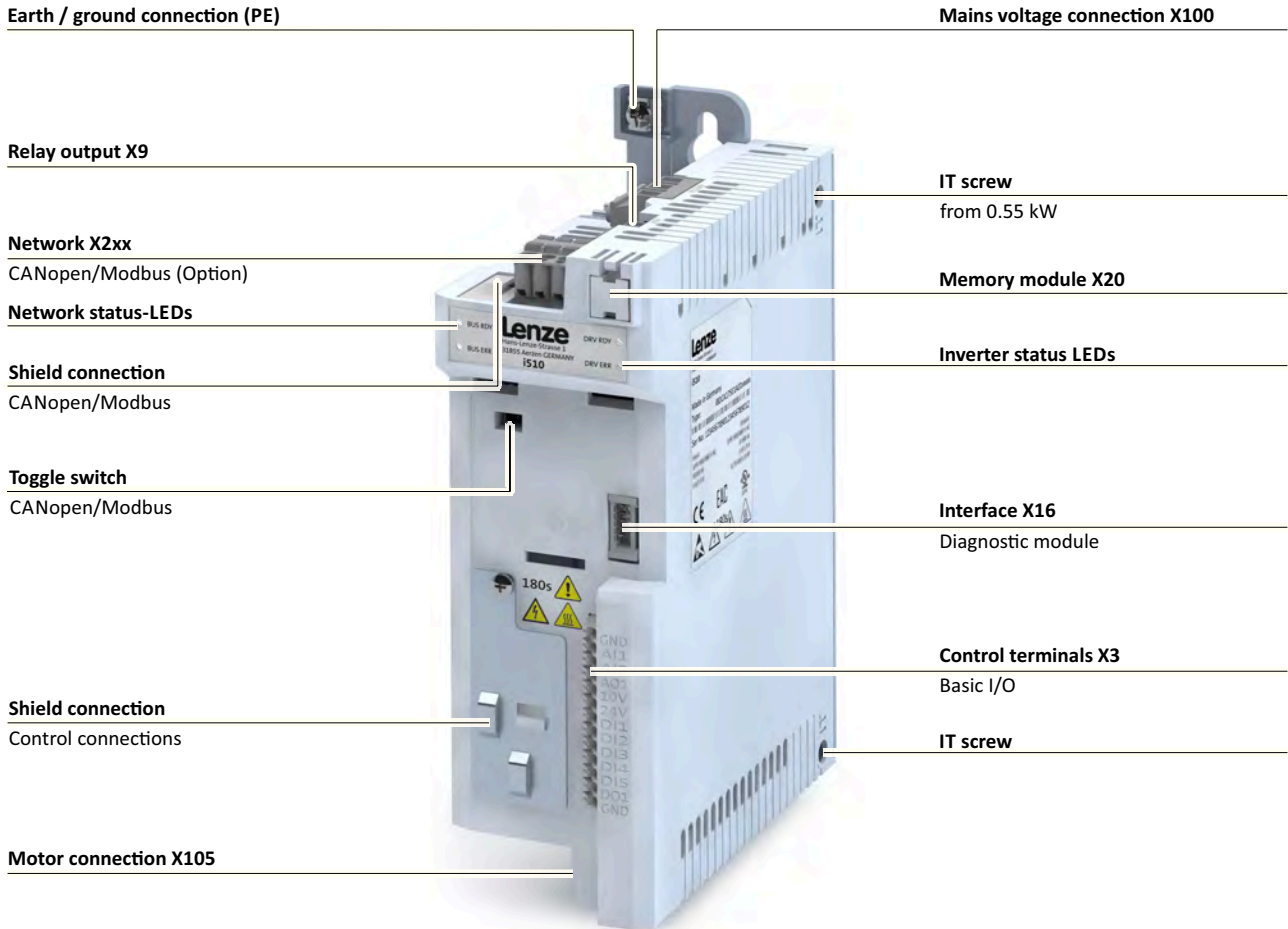

Product information

Features



Example of 3 kW ... 5.5 kW

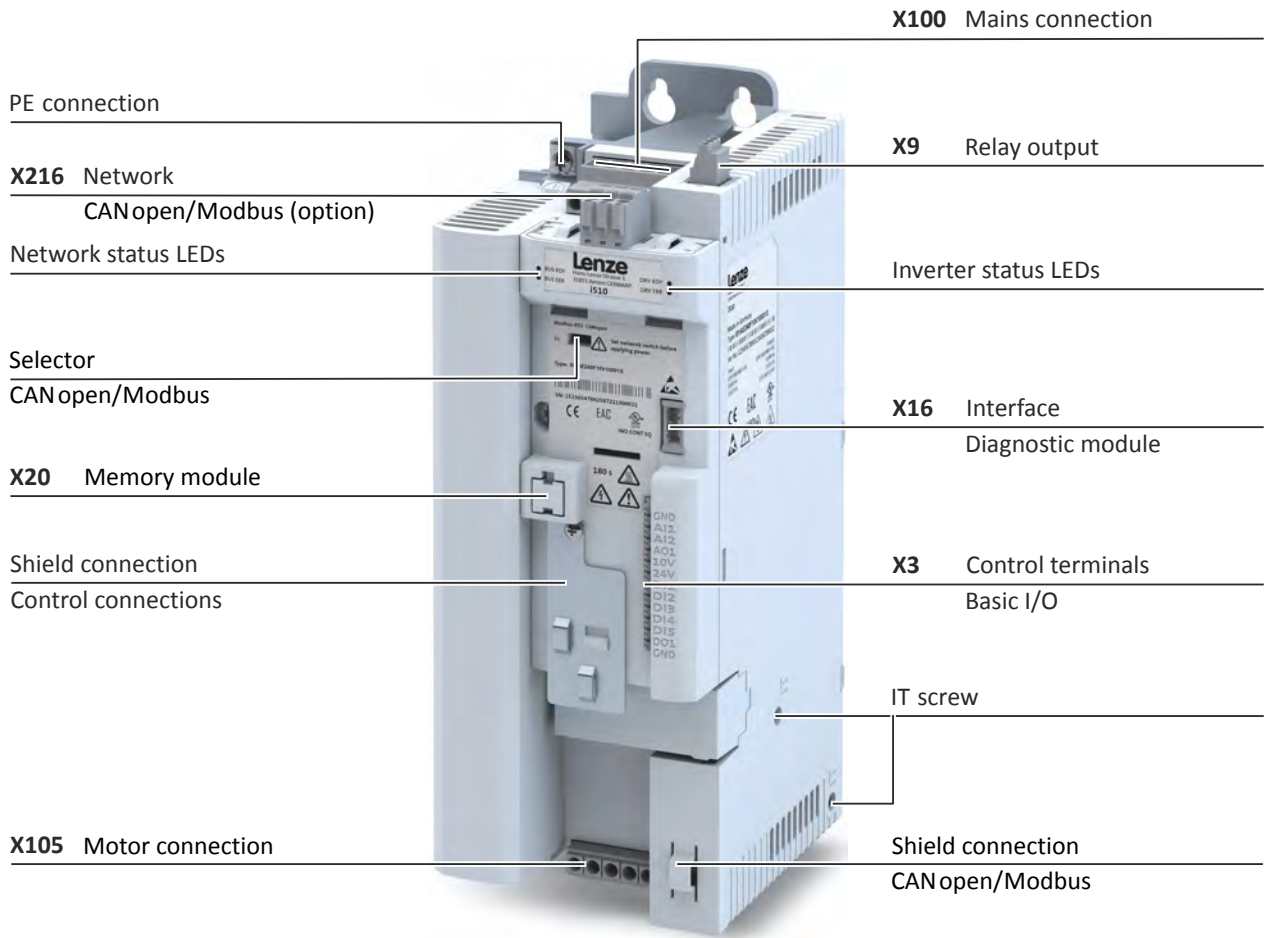



Example of 7.5 kW ... 11 kW

PE connection

X100 Mains connection

Network status LEDs

X9 Relay output

Selector

X216 Network

CAN open/Modbus

CAN open/Modbus (option)

X20 Memory module

Inverter status LEDs

Shield connection

Control connections

X16 Interface

Diagnostic module

X3 Control terminals

Basic I/O

IT screw

X105 Motor connection

Shield connection

CAN open/Modbus

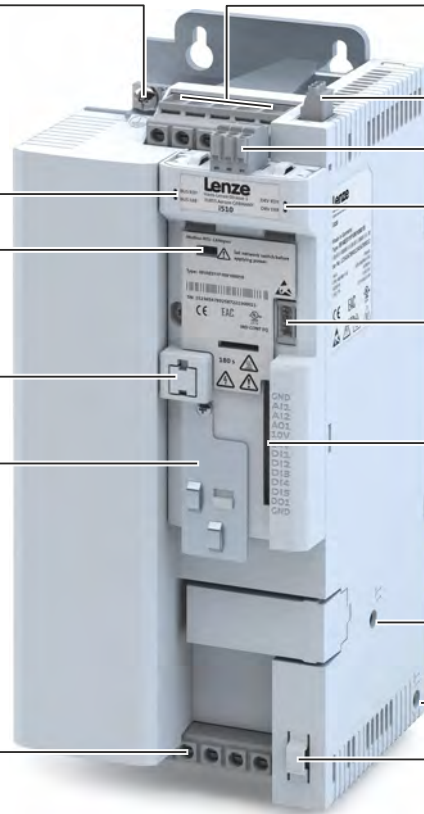

Position and meaning of the nameplates

Complete inverter



①	Technical data
②	Type and serial number of the inverter

Product information

The modular system
Topologies / network



The modular system

The concept

The inverter i510 is a compact device unit consisting of control unit and power unit.

The i510 is always delivered as a complete inverter.

2 versions are available:



- Without network.
- With CANopen/Modbus, switchable.

Topologies / network

The inverters can be equipped with different fieldbus networks.

The topologies and protocols typical for the prevailing networks are supported.

Currently available networks:

	CANopen® is a communication protocol based on CAN. CANopen® is a registered community trademark of the CAN user organisation CiA® (CAN in Automation e. V.). Device descriptions for the download: EDS files for Lenze devices
	The Modbus protocol is an open communication protocol based on a client/server architecture and developed for the communication with programmable logic controllers. Further development is carried out by the international user organisation Modbus Organization, USA.

More information on the supported networks can be found at:

<http://www.lenze.com>



Ways of commissioning

There are three methods to commission the inverter quickly and easily.

Thanks to Lenze's engineering philosophy, the high functionality is still easy to grasp. Parameterisation and set-up are impressive thanks to clear structure and simple dialogues, leading to the desired outcome quickly and reliably.

- Keypad
If it's only a matter of setting a few key parameters such as acceleration and deceleration time, this can be done quickly on the keypad.



- »EASY Starter«
If functions such as the holding brake control or sequencer need to be set, it's best to use the »EASY Starter« engineering tool.



- Smart-Keypad-App for Android or iOS
Ideal for the parameterisation of simple applications such as a conveyor belt.

The Lenze Smart Keypad app can be found in the Google Play Store or in the Apple App Store.

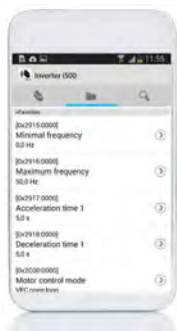

Android



iOS

Product information

Functions
Motor control types



Functions

Overview

The inverters i510 are adjusted to simple applications regarding their functionality.

Functions	
Motor control	Monitoring
V/f characteristic control linear/square-law (VFC plus)	Short circuit
Energy saving function (VFC-ECO)	earth fault
Sensorless vector control (SLVC)	Device overload monitoring (i^*t)
Sensorless control for synchronous motors (SL-PSM)	Motor overload monitoring (i^2*t)
Torque mode	Mains phase failure
Motor functions	Stalling protection
Flying restart circuit	Motor current limit
Slip compensation	Maximum torque
DC braking	Ultimate motor current
Oscillation damping	Motor speed monitoring
Skip frequencies	Load loss detection
Automatic identification of the motor data	Diagnostics
Brake energy management	Error history buffer
Holding brake control	Logbook
Voltage add – function	LED status displays
Rotational Energy Ride Through (RERT)	Keypad language selection German, English
Application functions	Network
Process controller	CANopen
Process controller - idle state and rinse function	Modbus RTU
Freely assignable favourite menu	
Parameter change-over	
S-shaped ramps for smooth acceleration	
Motor potentiometer	
Flexible I/O configuration	
Access protection	
Automatic restart	
OEM parameter set	
Sequencer	
Complete control with 8-key keypad	
UPS operation	
"Light Duty" load characteristic can be adjusted for selected inverters	

Motor control types

The following table contains the possible control types with Lenze motors.

Motors	V/f characteristic control	Sensorless vector control
	VFCplus	SLVC
Three-phase AC motors		
MD	•	•
MF	•	•
mH	•	•
m500	•	•



Features

Motor setting range

Rated point 120 Hz



Only possible with Lenze MF motors.

The rated motor torque is available up to 120 Hz.

Compared to the 50-Hz operation, the setting range increases by 2.5 times.

Thus, a smaller motor can be selected at the same rated power.

V/f at 120 Hz

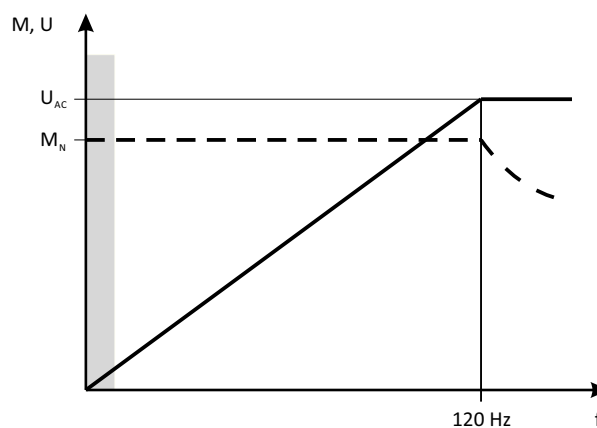

V Voltage
M Torque
f Frequency

U_{AC} Mains voltage
 M_{rated} Rated torque

Rated point 87 Hz

The rated motor torque is available up to 87 Hz.

Compared to the 50-Hz operation, the setting range increases by 1.74 times.

For this purpose, a motor with 230/400 V in star connection is driven by a 400-V inverter.

The inverter must be dimensioned for a rated motor current of 230 V.

Product information

Features
Motor setting range



V/f at 87 Hz

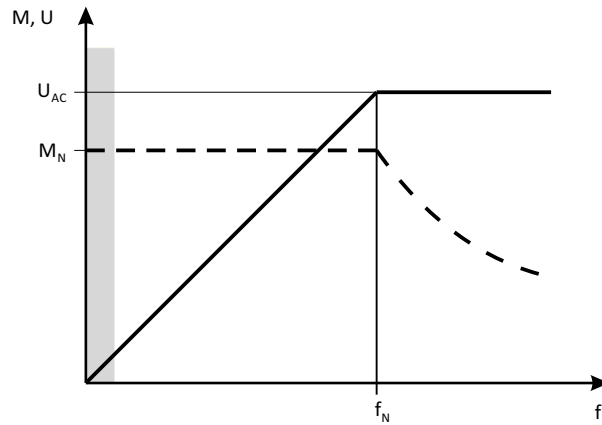

V Voltage
M Torque
f Frequency

U_{AC} Mains voltage
 M_{rated} Rated torque
 f_{rated} Rated frequency

Rated point 50 Hz

The rated motor torque is available up to 50 Hz.

V/f at 50 Hz

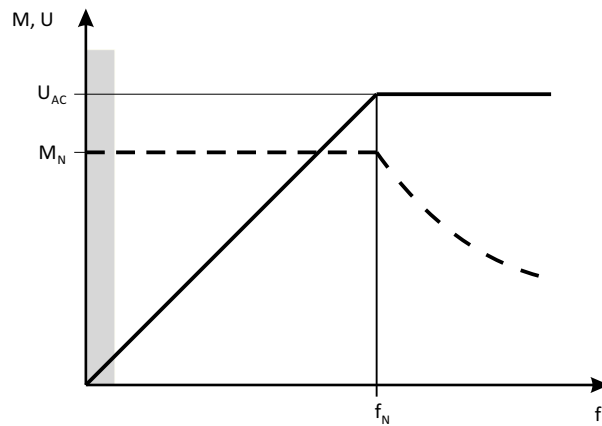

V Voltage
M Torque
f Frequency

U_{AC} Mains voltage
 M_{rated} Rated torque
 f_{rated} Rated frequency



Information on project planning

Project planning process

Dimensioning

3 methods for dimensioning

Fast: Selection of the inverter based on the motor data of a 4-pole asynchronous motor.

Detailed: In order to optimise the selection of the inverter and all drive components, it is worth to execute the detailed system dimensioning based on the physical requirements of the application. For this purpose, Lenze provides the «Drive Solution Designer» (DSD) design program.

Manual: The following chapter guides you step by step to the selection of a drive system.

Workflow of a configuration process

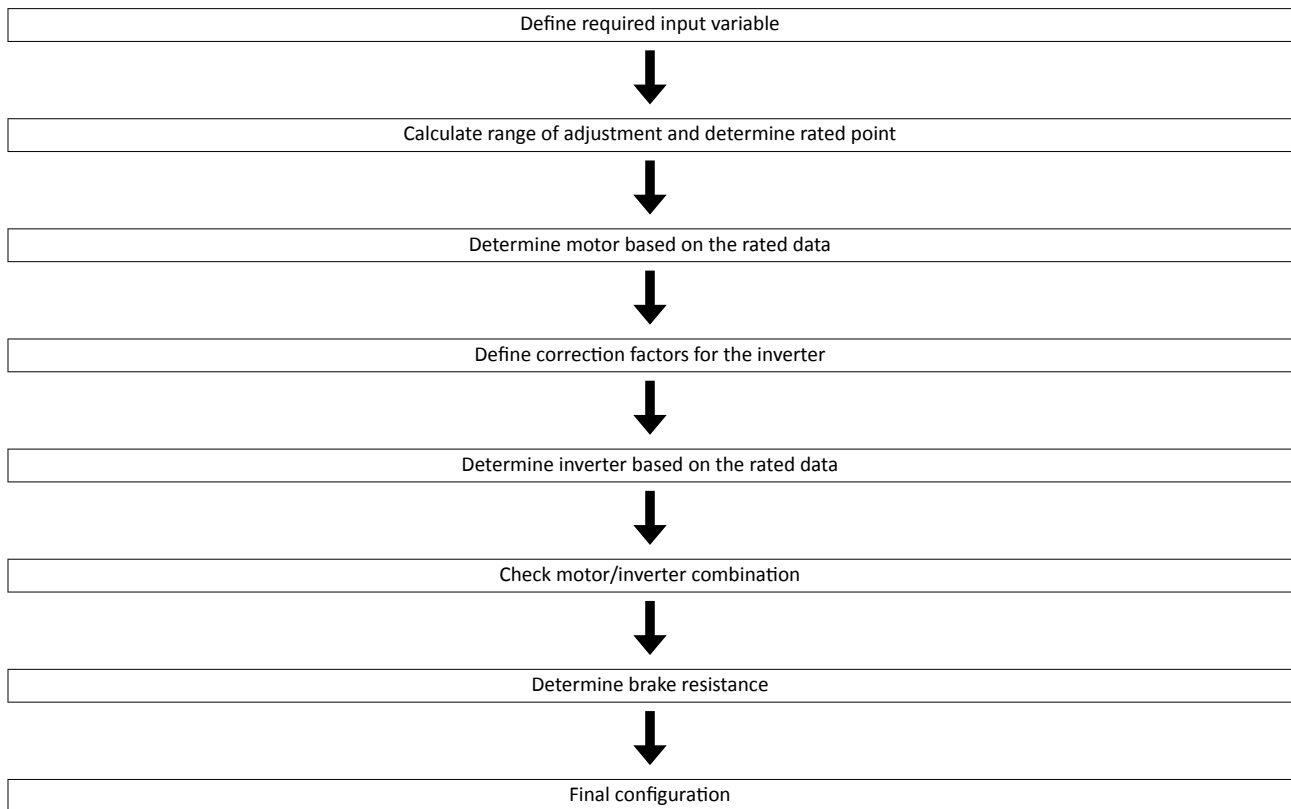

Define required input variables

Operating mode			S1 or S6
Max. load torque	$M_{L,max}$	Nm	
Max. load speed	$n_{L,max}$	rpm	
Min. load speed	$n_{L,min}$	rpm	
Site altitude	H	m	
Temperature in the control cabinet	T_U	°C	

Information on project planning

Project planning process
Dimensioning



Calculate range of adjustment and determine rated point

	Calculation	
Setting range	$V = \frac{n_{L,max}}{n_{L,min}}$	
	Setting range	Rated point
Motor with integral fan	≤ 2.50 (20 - 50 Hz) ≤ 4.35 (20 - 87Hz) ≤ 6 (20 - 120Hz)	50 Hz 87 Hz 120 Hz
Motor with blower	≤ 10.0 (5 - 50 Hz)	50 Hz
Motor with integral fan (reduced torque)	≤ 17.4 (5 - 87Hz) ≤ 24 (5 - 120Hz)	87 Hz 120 Hz

Determine motor based on the rated data

			Check
Rated torque			
Operating mode S1	M_{rated}	Nm	$M_N \geq \frac{M_{L,max}}{T_{H,Mot} \times T_{U,Mot}}$
Operating mode S6	M_{rated}	Nm	$M_N \geq \frac{M_{L,max}}{2 \times T_{H,Mot} \times T_{U,Mot}}$
Rated speed	n_{rated}	rpm	$n_{rated} \geq n_{L,max}$ $\frac{n_n}{V} \leq n_{L,min}$

			Note
Rated torque	M_{rated}	Nm	→ Rated motor data
Rated speed	n_{rated}	rpm	
Rated point at		Hz	→ setting range
Power factor	$\cos \varphi$		→ Rated motor data
Rated current	$I_{N,MOT}$	A	
Rated power	P_{rated}	kW	
Correction factor - site altitude	$T_{H,MOT}$		→ Technical motor data
Correction factor - ambient temperature	$T_{U,MOT}$		
Select motor			

Correction factors for the inverter

Site altitude Amsl	H				
	[m]	≤ 1000	≤ 2000	≤ 3000	≤ 4000
$k_{H,INV}$		1.00	0.95	0.90	0.85
Temperature in the control cabinet	T_U				
	[°C]	≤ 40	≤ 45	≤ 50	≤ 55
Switching frequency					
2 or 4 kHz	$k_{TU,INV}$	1.00	1.00	0.875	0.750
8 or 16 kHz		1.00	0.875	0.750	0.625
Switching frequency with the "Light Duty" load characteristic					
2 or 4 kHz	$k_{TU,INV}$	1.00	0.875	0.750	-
8 or 16 kHz		-	-	-	-

Determine inverter based on the rated data

			Check
Output current			
Continuous operation	I_{out}	A	$I_{out} \geq I_{N,Mot} / (k_{H,INV} \times k_{TU,INV})$
Overcurrent operation cycle 15 s	I_{out}	A	$I_{out} \geq I_{N,Mot} \times 2 / (k_{H,INV} \times k_{TU,INV})$
Overcurrent operation cycle 180 s	I_{out}	A	$I_{out} \geq I_{N,Mot} \times 1.5 / (k_{H,INV} \times k_{TU,INV})$



Determine the inverter based on the rated data for the "Light Duty" load characteristic

			Check
Output current			
Continuous operation	I_{out}	A	$I_{out} \geq I_{N,Mot} / (k_{H,INV} \times k_{TU,INV})$
Overcurrent operation cycle 15 s	I_{out}	A	$I_{out} \geq I_{N,Mot} \times 1.65 / (k_{H,INV} \times k_{TU,INV})$
Overcurrent operation cycle 180 s	I_{out}	A	$I_{out} \geq I_{N,Mot} \times 1.25 / (k_{H,INV} \times k_{TU,INV})$

Check motor/inverter combination

			Calculation
Motor torque	M	Nm	$M = \sqrt{\left(\frac{I_{out,INV}}{I_{N,MOT}}\right)^2 - (1 - \cos^2\varphi)} \times \frac{M_N}{\cos\varphi}$

			Check
Overload capacity of the inverter			$\frac{M_{L,max}}{M} \leq 1.5$

Braking operation without additional measures

To decelerate small masses, the "DC injection brake DCB" function can be parameterised. DC-injection braking enables a quick deceleration of the drive to standstill without the need for an external brake resistor.

- A code can be used to select the braking current.
- The maximum braking torque to be realised by the DC braking current amounts to approx. 20 ... 30 % of the rated motor torque. It is lower compared to braking action in generator mode with external brake resistor.
- Automatic DC-injection braking (Auto-DCB) improves the starting performance of the motor when the operation mode without speed feedback is used.

Final configuration

Product extensions and accessories can be found here:

- [Product extensions](#) 133
- [Accessories](#) 140

Operation in motor and generator mode

The energy analysis differs between operation in motor mode and generator mode.

During operation in motor mode, the energy flows from the supplying mains via the inverter to the motor which converts electrical energy into mechanical energy (e. g. for lifting a load).

During operation in generator mode, the energy flows back from the motor to the inverter. The motor converts the mechanical energy into electrical energy - it acts as a generator (e. g. when lowering a load).

The drive brakes the load in a controlled manner.

The energy recovery causes a rise in the DC-bus voltage. If this voltage exceeds an upper limit, the output stage of the inverter will be blocked to prevent the device from being destroyed.

The drive coasts until the DC-bus voltage reaches the permissible value range again.

Information on project planning

Project planning process
Overcurrent operation



Overcurrent operation

The inverters can be driven at higher amperages beyond the rated current if the duration of this overcurrent operation is time limited.

Two utilisation cycles of 15 s and 180 s are defined. Within these utilisation cycles, an overcurrent is possible for a certain time if afterwards an accordingly long recovery phase takes place.

Cycle 15 s

During this operation, the inverter may be loaded for 3 s with up to 200 % of the rated current if afterwards a recovery time of 12 s with max. 75 % of the rated current is observed. A cycle corresponds to 15 s.

Cycle 180 s

During this operation, the inverter may be loaded for 60 s with up to 150 % of the rated current if afterwards a recovery time of 120 s with max. 75 % of the rated current is observed. A cycle corresponds to 180 s.

The monitoring of the device utilisation (I_{xt}) causes the set error response if one of the two utilisation values exceeds the threshold of 100 %.



The maximum output currents correspond to the switching frequencies and the overload behaviour of the inverters are given in the rated data.

In case of rotating frequencies < 10 Hz, the time-related overload behaviour may be reduced.

The graphics shows a cycle. The basic conditions given in the table (graphics field highlighted in grey) have to be complied with in order that the inverter will not be overloaded. Both cycles can be combined with each other.

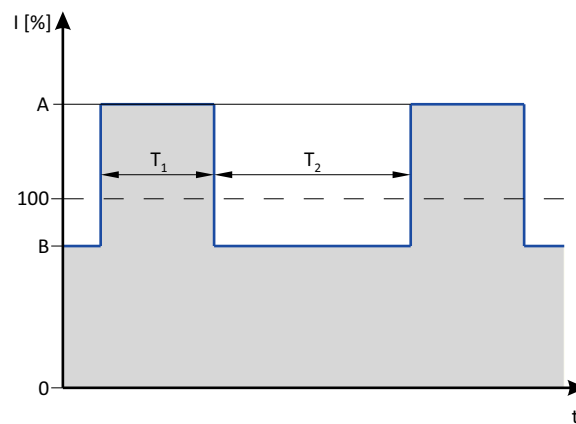

	Max. output current	Max. overload time	Max. output current during the recovery time	Min. recovery time
	A	T_1	B	T_2
	%	s	%	s
Cycle 15 s	200	3	75	12
Cycle 180 s	150	60	75	120



Inverter load characteristics

The inverter has two different load characteristics: "Light Duty" and "Heavy Duty". The "Light Duty" load characteristic allows for a higher output current with restrictions regarding over-load capacity, ambient temperature and switching frequency. This allows the motor required for the application to be driven by a less powerful inverter. Select the load characteristic according to the application.

Heavy Duty compared to Light Duty

This table compares the two load characteristics:

	Heavy Duty	Light duty
Characteristics	High dynamic requirements	Low dynamic requirements
Typical applications	Main tool drives, travelling drives, hoist drives, winders, forming drives and conveyors	Pumps, fans, general horizontal materials handling technology and line drives
Overload capacity	3 s/200 %, 60 s/150 % See technical data	Restricted Ssee technical data



Devices with Light Duty load characteristic: See [81](#), [99](#), [120](#)

Comply with all data for this load characteristic and the corresponding mains voltage range. This comprises the information on the type of installation as well as the required fuses, cable cross-sections, mains chokes and filters.

Information on project planning

Safety instructions
Basic safety instructions



Safety instructions

Disregarding the following basic safety measures and safety information may lead to severe personal injury and damage to property!

Observe all specifications of the corresponding documentation supplied. This is the precondition for safe and trouble-free operation and for obtaining the product features specified.

Please observe the specific safety information in the other sections!

DANGER!

Electrical voltage

Possible consequences: Death or severe injuries

- ▶ Any work on the inverter must only be carried out in the deenergised state.
 - ▶ Inverter up to 45 kW: After switching off the mains voltage, wait for at least 180 s before you start working.
 - ▶ Inverter from 55 kW onwards: After switching off the mains voltage, wait for at least 600 s before you start working.
-

Basic safety instructions

Personnel

The product must only be used by qualified personnel. IEC 60364 or CENELEC HD 384 define the skills of these persons:

- They are familiar with installing, mounting, commissioning, and operating the product.
- They have the corresponding qualifications for their work.
- They know and can apply all regulations for the prevention of accidents, directives, and laws applicable at the place of use.

Process engineering

The procedural notes and circuit details described are only proposals. It is up to the user to check whether they can be adapted to the particular applications. Lenze does not take any responsibility for the suitability of the procedures and circuit proposals described.



Application as directed

- The product must only be operated under the operating conditions prescribed in this documentation.
- The product meets the protection requirements of 2014/35/EU: Low-Voltage Directive.
- The product is not a machine in terms of 2006/42/EU: Machinery Directive.
- Commissioning or starting the operation as directed of a machine with the product is not permitted until it has been ensured that the machine meets the regulations of the EU Directive 2006/42/EU: Machinery Directive; observe EN 60204-1.
- Commissioning or starting operation as directed is only permissible if the EMC Directive 2014/30/EU is complied with.
- The harmonised standard EN 61800-5-1 is applied.
- The product is not a household appliance, but is only designed as a component for commercial or professional use in terms of EN 61000-3-2.
- The product can be used according to the technical data if drive systems have to comply with categories according to EN 61800-3.

In residential areas, the product may cause EMC interferences. The operator is responsible for taking interference suppression measures.

- The product must only be actuated with motors that are suitable for the operation with inverters.
 - Lenze L-force motors meet the requirements
 - Exception: m240 motors are designed for mains operation only.

Use of explosion-proof motors

Explosion-proof motors that are not designed for use with an inverter invalidate their approval when used for variable speed applications. Due to the many areas of liability that may arise when handling these applications, the following declaration of principle applies:



The inverters from Lenze are sold without warranty of suitability for a particular purpose or warranty of suitability for use in explosion-proof motors. Lenze assumes no responsibility for any direct, incidental, or consequential damages, costs, or losses that may result from the use of AC inverters in these applications. The purchaser explicitly agrees to assume any risk of loss, cost or damage that may result from such use.

Information on project planning

Safety instructions
Handling



Handling

Transport, storage

Observe the notes regarding transport, storage and correct handling. Ensure proper handling and avoid mechanical stress. Do not bend any components and do not change any insulation distances during transport or handling. Do not touch any electronic components and contacts. Inverters contain electrostatically sensitive components which can easily be damaged by inappropriate handling. Do not damage or destroy any electrical components since thereby your health could be endangered!

Installation

The technical data and supply conditions can be obtained from the nameplate and the documentation. They must be strictly observed.

The inverters have to be installed and cooled according to the regulations given in the corresponding documentation. Observe the climatic conditions according to the technical data. The ambient air must not exceed the degree of pollution 2 according to EN 61800-5-1.

Electrical connection

When working on live inverters, observe the applicable national regulations for the prevention of accidents.

The electrical installation must be carried out according to the appropriate regulations (e. g. cable cross-sections, fuses, PE connection). Additional information can be obtained from the documentation.

The documentation contains notes about installation according to EMC regulations (such as shielding, grounding, filters and cable routing). Also observe these notes for CE-marked inverters. The manufacturer of the system or machine is responsible for adherence to the limits required in connection with EMC legislation. The inverters must be installed in housings (e. g. control cabinets) to meet the limit values for radio interferences valid at the site of installation. The housings have to enable an EMC-compliant installation. In particular observe that e. g. control cabinet doors preferably have a circumferential metallic connection to the housing. Reduce openings or cutouts through the housing to a minimum.

Inverters may cause a DC current in the PE conductor. If a residual current device (RCD) is used for protection against direct or indirect contact for an inverter with three-phase supply, only a residual current device (RCD) of type B is permissible on the supply side of the inverter. If the inverter has a single-phase supply, a residual current device (RCD) of type A is also permissible. Apart from using a residual current device (RCD), other protective measures can be taken as well, e. g. electrical isolation by double or reinforced insulation or isolation from the supply system by means of a transformer.

Operation

If necessary, systems including inverters must be equipped with additional monitoring and protection devices. Also comply with the safety regulations and provisions valid at the installation site.

After the inverter has been disconnected from the supply voltage, all live components and power terminals must not be touched immediately because capacitors can still be charged. Please observe the corresponding stickers on the inverter.

All protection covers and doors must be shut during operation.

You may adapt the inverters to your application by parameter setting within the limits available. For this, observe the notes in the documentation.

Maintenance and servicing

The inverters do not require any maintenance if the prescribed operating conditions are observed.

Disposal

In accordance with the current provisions, inverters and accessories have to be disposed of by means of professional recycling. Inverters contain recyclable raw material such as metal, plastics and electronic components.



Residual hazards

Even if notes given are taken into consideration and protective measures are implemented, the occurrence of residual risks cannot be fully prevented.

The user must take the residual hazards mentioned into consideration in the risk assessment for his/her machine/system.

If the above is disregarded, this can lead to severe injuries to persons and damage to property!

Protection of persons

Before working on the inverter, check if no voltage is applied to the power terminals.

- Depending on the device, the power terminals X105 remain live for up to 3 ... 20 minutes.
- The power terminals X100 and X105 remain live even when the motor is stopped.

Motor protection

With some settings of the inverter, the connected motor can be overheated.

- E. g. by longer operation of self-ventilated motors at low speed.
- E. g. by longer operation of the DC-injection brake.

Protection of the machine/system

Drives can reach dangerous overspeeds.

- E. g. by setting high output frequencies in connection with motors and machines not suitable for this purpose.
- The inverters do not provide protection against such operating conditions. For this purpose, use additional components.

Switch contactors in the motor cable only if the controller is inhibited.

- Switching while the inverter is enabled is only permissible if no monitoring functions are activated.

Motor

If there is a short circuit of two power transistors, a residual movement of up to $180^\circ/\text{number of pole pairs}$ can occur at the motor! (e. g. 4-pole motor: residual movement max. $180^\circ/2 = 90^\circ$).

Parameter set transfer

During the parameter set transfer, control terminals of the inverters can adopt undefined states.

- Thus, the control terminal of the digital input signals have to be removed before the transfer.
- This ensures that the inverter is inhibited. The control terminals are in a defined state.

Degree of protection - protection of persons and device protection

- Information applies to the mounted and ready-for-use state.
- Information does not apply to the wire range of the terminals.
 - Terminals that are not assigned only have a low protection against contact.
 - Terminals for large cable cross-sections have lower classes of protection, e. g. from 15 kW IP10 only.

Device exchange without tool

Exchange a maximum of one safe device before recommissioning.

Exchange of devices

Test the compatibility of the devices before exchanging.

Information on project planning

Safety instructions
Residual hazards



Risks when exchanging devices

WARNING!

Incorrect handling of devices.

Device damage.

- ▶ Check the compatibility of the devices before exchanging.
 - ▶ Check the memory cards of the devices before exchanging.
 - ▶ Set the safety address.
 - ▶ Undertake a functional check after the exchange.
-



Control cabinet structure

Control cabinet requirements

- Protection against electromagnetic interferences
- Compliance with the ambient conditions of the installed components

Mounting plate requirements

- The mounting plate must be electrically conductive.
 - Use zinc-coated mounting plates or mounting plates made of V2A.
 - Varnished mounting plates are unsuitable, even if the varnish is removed from the contact surfaces.
- When using several mounting plates, make a conductive connection over a large surface (e. g. using grounding strips).

Arrangement of components

- Division into power and control areas

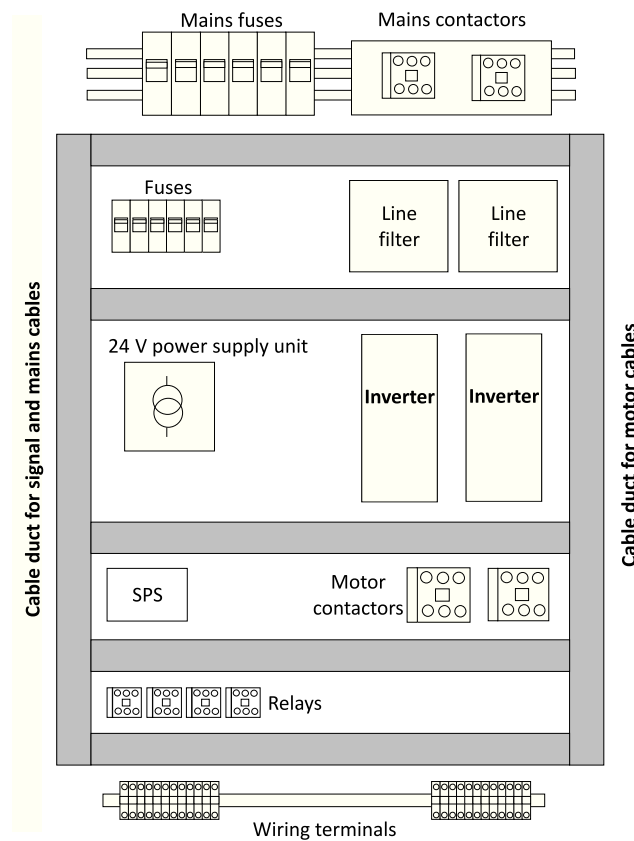

Fig. 1: Example for the ideal arrangement of components in the control cabinet

Information on project planning

Control cabinet structure
Earthing concept



Cables

Requirements

- The cables used must correspond to the requirements at the location (e. g. EN 60204–1, UL).
- The cable cross-section must be dimensioned for the assigned fusing. Observe national and regional regulations.
- You must observe the regulations for minimum cross-sections of PE conductors. The cross-section of the PE conductor must be at least as large as the cross-section of the power connections.

Installation inside the control cabinet

- Always install cables close to the mounting plate (reference potential), as freely suspended cables act like aerials.
- Use separated cable channels for motor cables and control cables. Do not mix up different cable types in one cable channel.
- Lead the cables to the terminals in a straight line (avoid tangles of cables).
- Minimise coupling capacities and coupling inductances by avoiding unnecessary cable lengths and reserve loops.
- Short-circuit unused cores to the reference potential.
- Install the cables of a 24 V DC supply (positive and negative cable) close to each other or twisted over the entire length to avoid loops.

Installation outside the control cabinet

- In the case of greater cable lengths, a greater cable distance between the cables is required.
- In the case of parallel routing (cable trays) of cables with different types of signals, the degree of interference can be minimised by using a metallic cable separator or isolated cable ducts.

Earthing concept

- Set up the earthing system with a star topology.
- Connect all components (inverters, filters, chokes) to a central earthing point (PE rail).
- Comply with the corresponding minimum cross-sections of the cables.
- When using several mounting plates, make a conductive connection over a large surface (e. g. using grounding strips).



EMC-compliant installation

Structure of a CE-typical drive system

The drive system (frequency inverter and drive) corresponds to 2014/30/EU: EMC Directive if it is installed according to the specifications of the CE-typical drive system.

The structure in the control cabinet must support the EMC-compliant installation with shielded cables.

- Please use highly conductive shield connections.
- Connect the housing with shielding effect to the grounded mounting plate with a surface as large as possible, e. g. of inverters and RFI filters.
- Use central earthing points.

Matching accessories makes effective shielding easier.

- Shield sheets
- Shield clips/shield clamps
- Metallic cable ties

Mains connection

- Inverters, mains chokes, or mains filters may only be connected to the mains via unshielded single cores or unshielded cables.
- When a line filter is used, shield the cable between mains filter or RFI filter and inverter if its length exceeds 300 mm. Unshielded cores must be twisted.

Motor cable

- Only use low-capacitance and shielded motor cables with braid made of tinned or nickel-plated copper.
 - The overlap rate of the braid must be at least 70 % with an overlap angle of 90 °.
 - Shields made of steel braids are not suitable.
- Shield the cable for motor temperature monitoring (PTC or thermal contact) and install it separately from the motor cable.
 - In Lenze system cables, the cable for brake control is integrated into the motor cable. If this cable is not required for brake control, it can also be used to connect the motor temperature monitoring up to a length of 50 m.
 - Only certain inverters are provided with this connection facility.
- Connect the shield with a large surface and fix it with metal cable binders or conductive clamp. The following is suitable for the connection of the shield:
 - The mounting plate
 - A central grounding rail
 - A shielding plate, if necessary, optional
- This is optimal:
 - The motor cable is separated from the mains cables and control cables.
 - The motor cable only crosses mains cables and control cables at right angles.
 - The motor cable is not interrupted.
- If the motor cable must be opened all the same (e. g. by chokes, contactors, or terminals):
 - The unshielded cable ends must not be longer than 100 mm (depending on the cable cross-section).
 - Install chokes, contactors, terminals etc. spatially separated from other components (with a minimum distance of 100 mm).
 - Install the shield of the motor cable directly before and behind the point of separation to the mounting plate with a large surface.
- Connect the shield with a large surface to PE in the terminal box of the motor at the motor housing.
 - Metal EMC cable glands at the motor terminal box ensure a large surface connection of the shield with the motor housing.

Information on project planning

Control cabinet structure
EMC-compliant installation



Control cables

- Install the cables so that no induction-sensitive loops arise.
- Distance of shield connections of control cables to shield connections of motor cables and DC cables:
 - At least 50 mm
- Control cables for analog signals:
 - Must always be shielded
 - Connect the shield on one side of the inverter
- Control cables for digital signals:

Type	Cable length		
	< ca. 5 m	ca. 5 m ... ca. 30 m	> ca. 30 m
	unshielded option	unshielded twisted option	always shielded connected on both sides

Network cables

- Cables and wiring must comply with the specifications and requirements of the used network.
 - Ensures the reliable operation of the network in typical systems.

Detecting and eliminating EMC interferences

Trouble	Cause	Remedy
Interferences of analog setpoints of your own or other devices and measuring systems	Unshielded motor cable has been used	Use shielded motor cable
	Shield contact is not extensive enough	Carry out optimal shielding as specified
	Shield of the motor cable is interrupted, e. g. by terminal strips, switches etc.	<ul style="list-style-type: none"> • Separate components from other component parts with a minimum distance of 100 mm • Use motor chokes or motor filters
	Additional unshielded cables inside the motor cable have been installed, e. g. for motor temperature monitoring	Install and shield additional cables separately
	Too long and unshielded cable ends of the motor cable	Shorten unshielded cable ends to maximally 40 mm
Conducted interference level is exceeded on the supply side	Terminal strips for the motor cable are directly located next to the mains terminals	Spatially separate the terminal strips for the motor cable from mains terminals and other control terminals with a minimum distance of 100 mm
	Mounting plate varnished	Optimise PE connection: <ul style="list-style-type: none"> • Remove varnish • Use zinc-coated mounting plate
	HF short circuit	Check cable routing



Information on mechanical installation

Important notes

Measures for cooling during operation

- Ensure unimpeded ventilation of cooling air and outlet of exhaust air.
- If the cooling air is polluted (fluff, (conductive) dust, soot, grease, aggressive gases), take adequate countermeasures.
 - Install filters.
 - Arrange for regular cleaning of the filters.
- If required, implement a separate air guide.

Preparation

Further data and information for mechanical mounting:

▶ [Control cabinet structure](#) 31

▶ [Dimensions](#) 128



The scope of supply of the inverter comprises mounting instructions. They describe technical data and information on mechanical and electrical installation.

Mounting position

- Vertical alignment - all mains connections are at the top and the motor connections at the bottom.

Free spaces

- Maintain the specified free spaces above and below to the other installations.

Mechanical installation

- The mounting location and material must ensure a durable mechanical connection.
- Do not mount onto DIN rails!
- In case of continuous vibrations or shocks use vibration dampers.

How to mount the inverters onto the mounting plate.

Preconditions:

- Mounting plate with conductive surface

Required:

- Tool for drilling and thread cutting
- Screwdriver
- Screw and washer assemblies or hexagon socket screws with washers.

1. Prepare mounting plate with corresponding threaded holes.
2. Fit screws and washers (if applicable).
3. Do not yet tighten the screws.
4. Mount the inverter on the prepared mounting plate via keyhole suspension.
5. Only tighten the screws hand-tight.
6. Pre-assemble further units if necessary.
7. Align the units with each other.
8. Screw the units onto the mounting plate.

The inverters are mounted on the mounting plate. You can begin with the wiring.

Screw and washer assemblies or hexagon socket screws with washers are recommended..

M5 x \geq 10 mm for devices up to and including 2.2 kW

M5 x \geq 12 mm for devices up to and including 11 kW



Information on electrical installation

Important notes

DANGER!

Electrical voltage

Possible consequences: Death or severe injuries

- ▶ Any work on the inverter must only be carried out in the deenergised state.
- ▶ Inverter up to 45 kW: After switching off the mains voltage, wait for at least 180 s before you start working.
- ▶ Inverter from 55 kW onwards: After switching off the mains voltage, wait for at least 600 s before you start working.

DANGER!

Dangerous electrical voltage

The leakage current against earth (PE) is > 3.5 mA AC or > 10 mA DC.

Possible consequences: Death or severe injuries when touching the device in the event of an error.

- ▶ Implement the measures requested in EN 61800-5-1 or EN 60204-1. Especially:
- ▶ Fixed installation
- ▶ The PE connection must comply with the standards (PE conductor diameter ≥ 10 mm² or use a double PE conductor)

NOTICE

No protection against excessively high mains voltage

The mains input is not fused internally.

Possible consequences: Destruction of the product in the event of excessively high mains voltage.

- ▶ Take note of the maximum permissible mains voltage.
- ▶ On the mains supply side, use fuses to adequately protect the product against mains fluctuations and voltage peaks.

DANGER!

Use of the inverter on a phase earthed mains with a rated mains voltage ≥ 400 V

The protection against accidental contact is not ensured without external measures.

- ▶ If protection against accidental contact according to EN 61800-5-1 is required for the control terminals of the inverters and the connections of the plugged device modules, ...
- ▶ an additional basic insulation has to be provided.
- ▶ the components to be connected have to come with a second basic insulation.



NOTICE

Overvoltage at devices with 230-V mains connection

An impermissible overvoltage may occur if the central supply of the N conductor is interrupted if the devices are connected to a TN three-phase system.

Possible consequences: Destruction of the device

- ▶ Provide for the use of isolating transformers.

NOTICE

The product contains electrostatic sensitive devices.

Possible consequences: Destruction of the device

- ▶ Before working in the connection area, the personnel must be free of electrostatic charge.

NOTICE

Pluggable terminal strips or plug connections

Plugging or removing the terminal strips or plug connections during operation may cause high voltages and arcing.

Possible consequences: Damage of the devices

- ▶ Switch off device.
- ▶ Only plug or remove the terminal strips or plug connections in deenergised status.

NOTICE

Use of mains filters and RFI filters in IT systems

Mains filters and RFI filters from Lenze contain components that are interconnected against PE.

Possible consequences: The filters may be destroyed when an earth fault occurs.

Possible consequences: Monitoring of the IT system may be triggered.

- ▶ Do not use mains filters and RFI filters from Lenze in IT systems.
- ▶ Before using the inverter in the IT system, remove the IT screws.

NOTICE

Overvoltage at components

In case of an earth fault in IT systems, intolerable overvoltages may occur in the plant.

Possible consequences: Destruction of the device.

- ▶ Before using the inverter in the IT system, the contact screws must be removed.
- ▶ Positions and number of the contact screws depend on the device.



Ensure a trouble-free operation:

Carry out the total wiring so that the separation of the separate potential areas is preserved.



When implementing machines and systems for the use in the UL/CSA scope, you have to observe the relevant special notes.

These notes are marked with "UL marking".



⚠ WARNING!

- ▶ **UL marking**
- ▶ Suitable for motor group installation.
- ▶ **0.55 kW ... 30 kW devices** on a circuit capable of delivering not more than 5k rms symmetrical amperes, 480 V maximum when protected by fuses or circuit breakers. Ratings see table below.
- ▶ **Devices from 45 kW** on a circuit capable of delivering not more than 10k rms symmetrical amperes, 480 V maximum when protected by fuses. Ratings see table below.
- ▶ **Marquage UL**
- ▶ Convient pour une installation de groupes de moteurs.
- ▶ **Appareils de 0,55 kW à 30 kW** sur un circuit non susceptible de délivrer plus de 5k A en valeur efficace, à 480 V maximum et avec une protection par fusibles ou par disjoncteurs. Se reporter au tableau ci-dessous pour connaître les caractéristiques assignées.
- ▶ **Appareils à partir de 45 kW** sur un circuit non susceptible de délivrer plus de 10k A en valeur efficace, à 480 V maximum et avec protection par fusibles. Se reporter au tableau ci-dessous pour connaître les caractéristiques assignées.



You have to install the devices into housings (e. g. control cabinets) to comply with valid regulations.

Stickers with warning notes must be displayed prominently and close to the device.

Preparation

Further data and information for electrical installation:

- ▶ [EMC-compliant installation](#) 33
- ▶ [Standards and operating conditions](#) 50



The scope of supply of the inverter comprises mounting instructions. They describe technical data and information on mechanical and electrical installation.

A good shield connection at the transitions of the different areas reduce possible interferences caused by problems with the EMC.

Example of an EMC-compliant cable gland

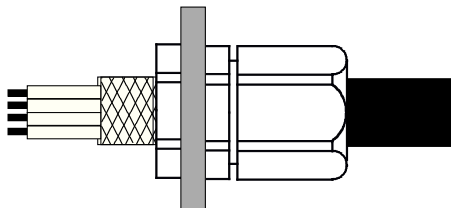

Fig. 2: EMC cable gland with a high degree of protection



Mains connection

The following should be considered for the mains connection of the inverter:

Single inverters are either directly connected to the **AC system** or via upstream filters. RFI filters are already integrated in many inverters. Depending on the requirements, mains chokes or mains filters can be used.

This enables the energy exchange in phases with operation in generator and motor mode of several drives in the network.

The technical data informs about the possible applications in the given groups. In the dimensioning, data and further notes have to be observed.

Information on electrical installation

Mains connection

1-phase mains connection 230/240 V



1-phase mains connection 230/240 V

The connection plan is valid for the inverters i510-Cxxx/230-1.

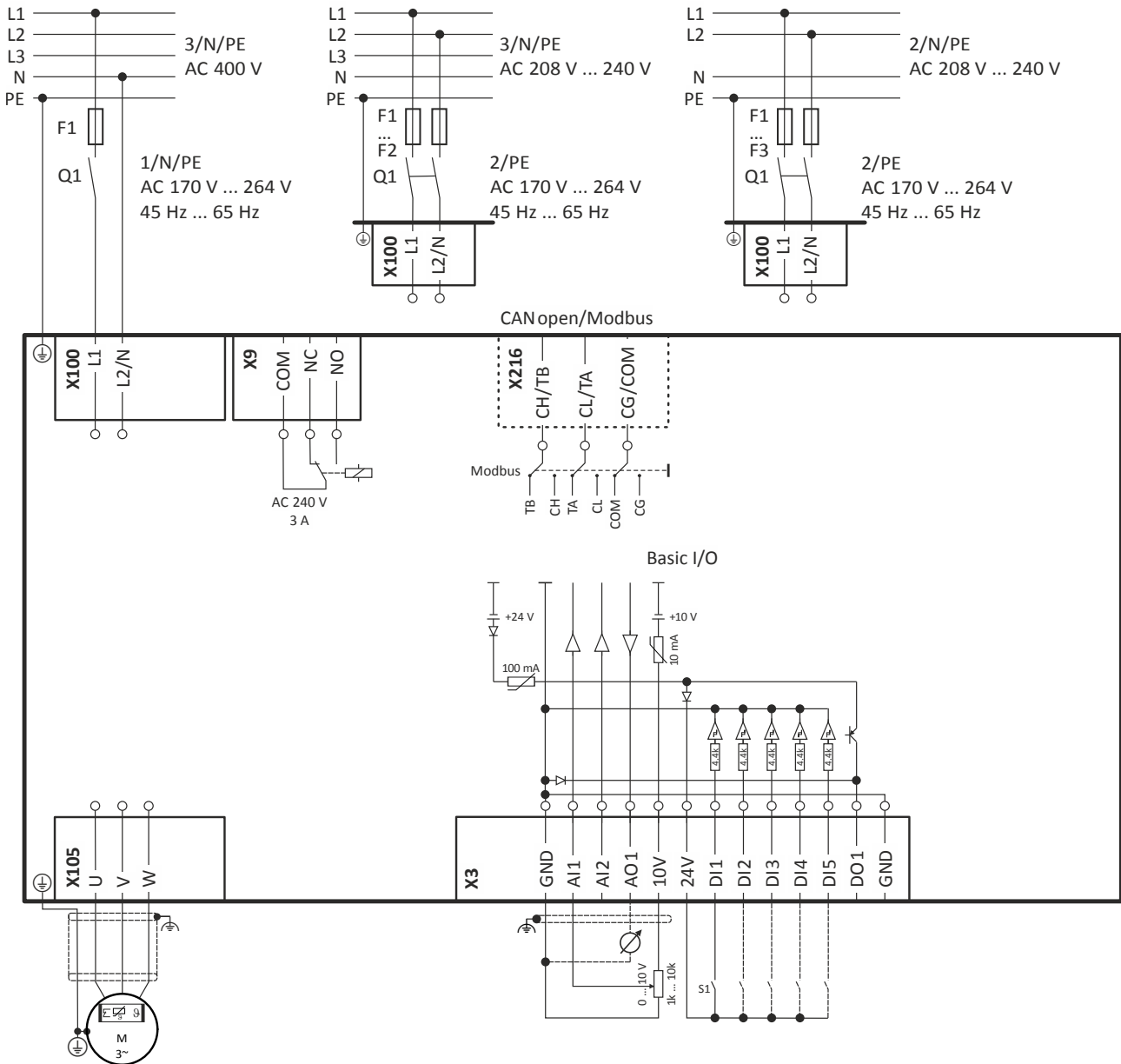

Fig. 3: Wiring example

S1 Start/Stop
F_x Fuses

Q1 Mains contactor
--- Dashed line = options



Information on electrical installation

Mains connection
1-phase mains connection 230/240 V

The connection plan is valid for the inverters i510-Cxxx/230-2.



Inverters i510-Cxxx/230-2 do not have an integrated RFI filter in the AC mains supply.

In order to meet the EMC requirements according to EN 61800-3, an external EMC filter according to IEC EN 60939 must be used.

The user must verify that the conformity with EN 61800-3 is fulfilled.

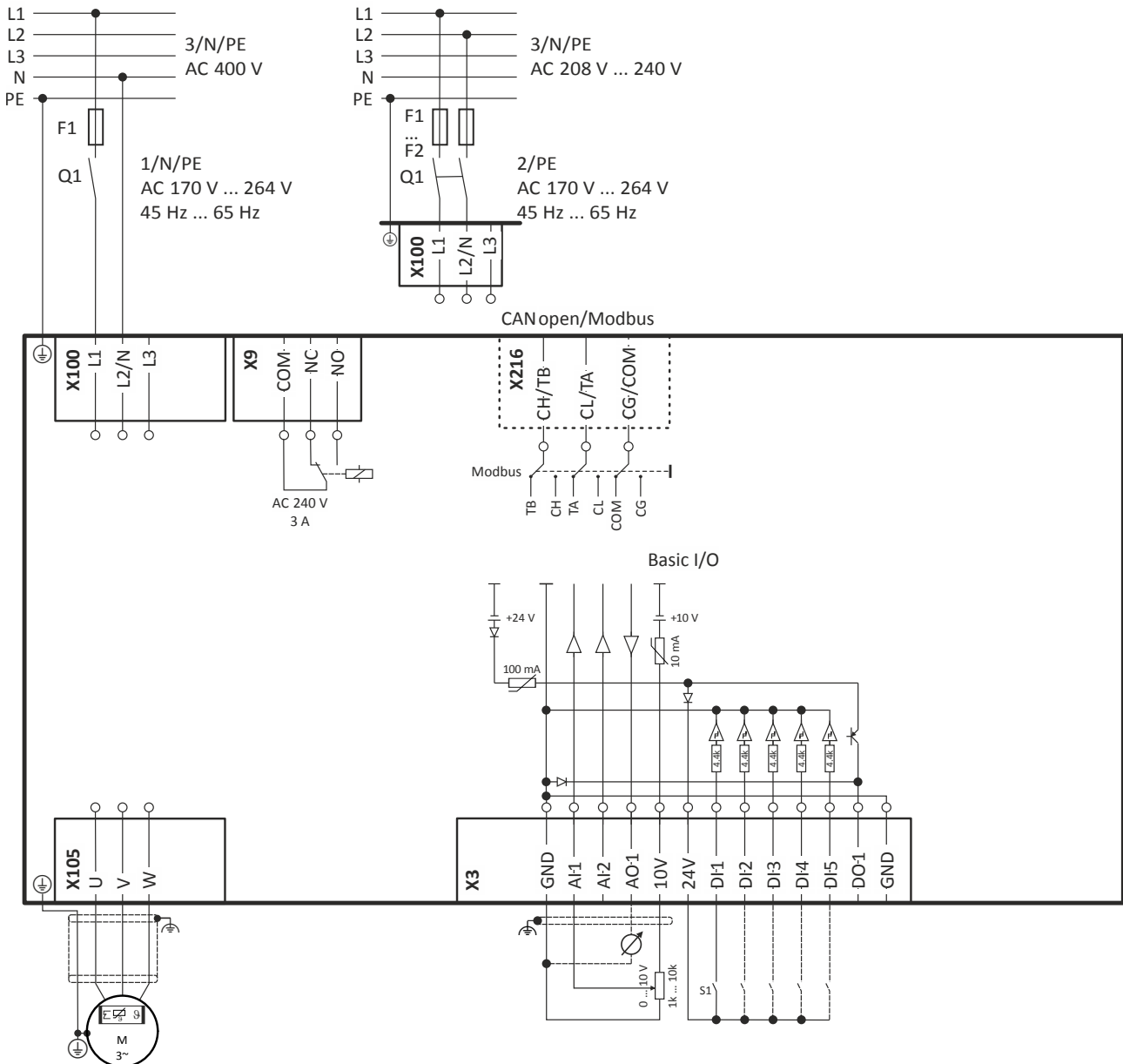

Fig. 4: Wiring example

S1 Start/Stop
Fx Fuses

Q1 Mains contactor
-- Dashed line = options

Information on electrical installation

Mains connection
3-phase mains connection 230/240 V



3-phase mains connection 230/240 V

The connection plan is valid for the inverter i510-Cxxx/230-3.



The i510-Cxxx/230-3 inverter does not have an integrated RFI filter in the AC mains supply.

In order to meet the EMC requirements according to EN 61800-3, an external EMC filter according to IEC EN 60939 must be used.

The user must verify that the conformity with EN 61800-3 is fulfilled.

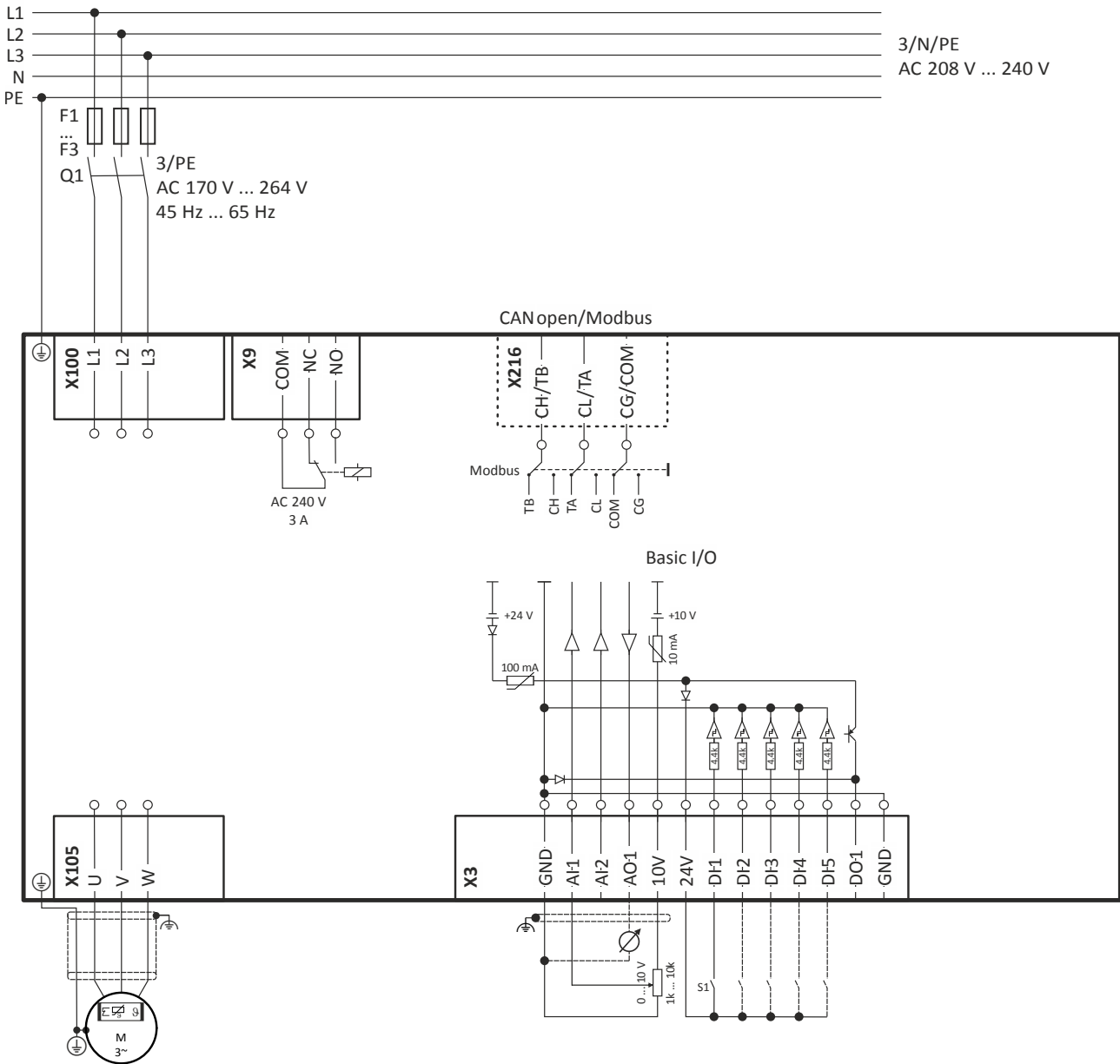

Fig. 5: Wiring example

S1 Start/Stop
Fx Fuses

Q1 Mains contactor
--- Dashed line = options



Information on electrical installation

Mains connection
3-phase mains connection 230/240 V "Light Duty"

The connection plan is valid for the i510-Cxxx/230-2 inverter.



The i510-Cxxx/230-2 inverter does not have an integrated RFI filter in the AC mains supply.

In order to meet the EMC requirements according to EN 61800-3, an external EMC filter according to IEC EN 60939 must be used.

The user must verify that the conformity with EN 61800-3 is fulfilled.

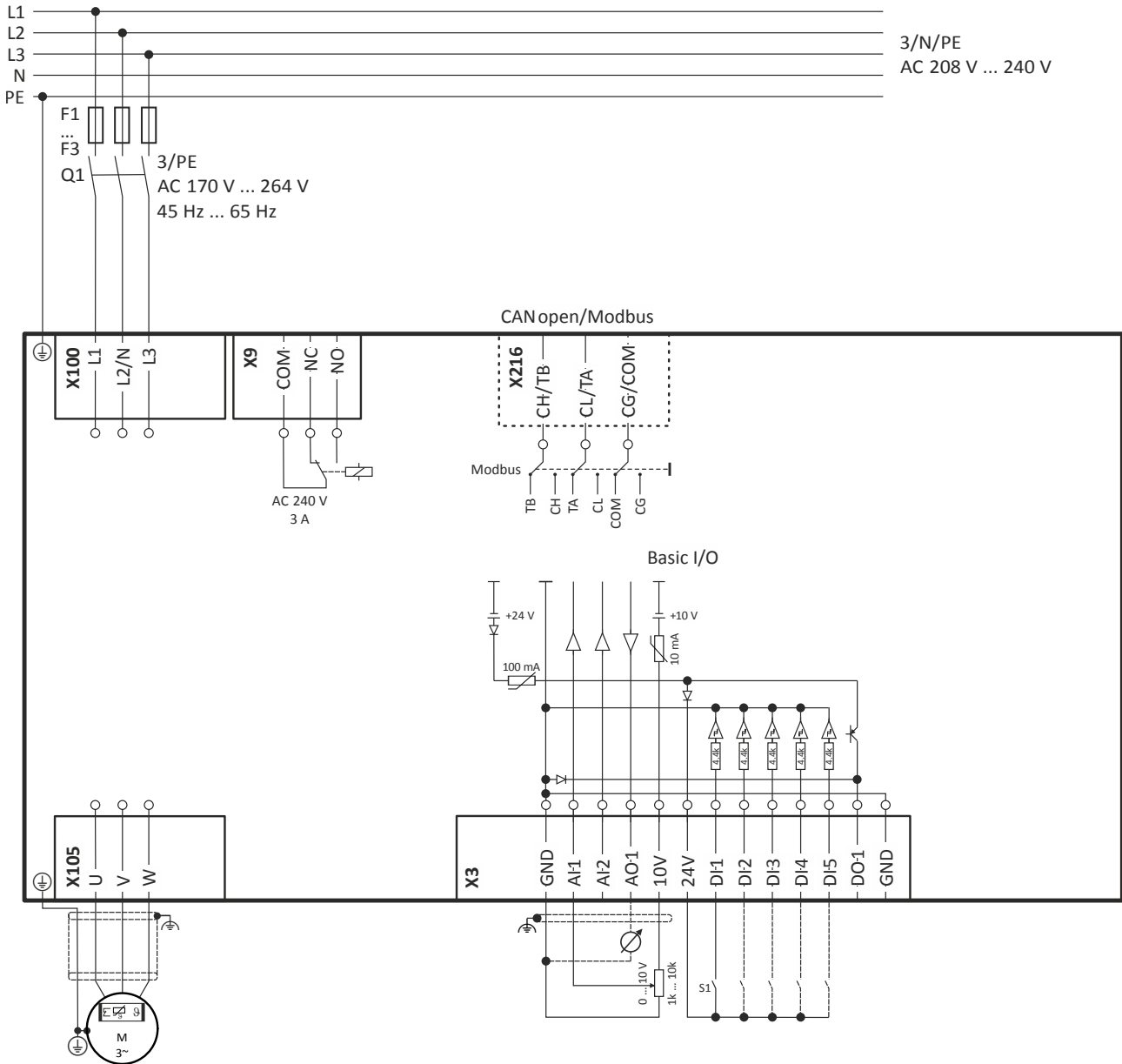

Fig. 6: Wiring example

S1 Start/Stop
Fx Fuses

Q1 Mains contactor
--- Dashed line = options

3-phase mains connection 230/240 V "Light Duty"

See "3-phase mains connection 230/240 V". [42](#)

Information on electrical installation

Mains connection
3-phase mains connection 400 V "Light Duty"



3-phase mains connection 400 V

The connection plan is valid for the inverters i510-Cxxx/400-3.

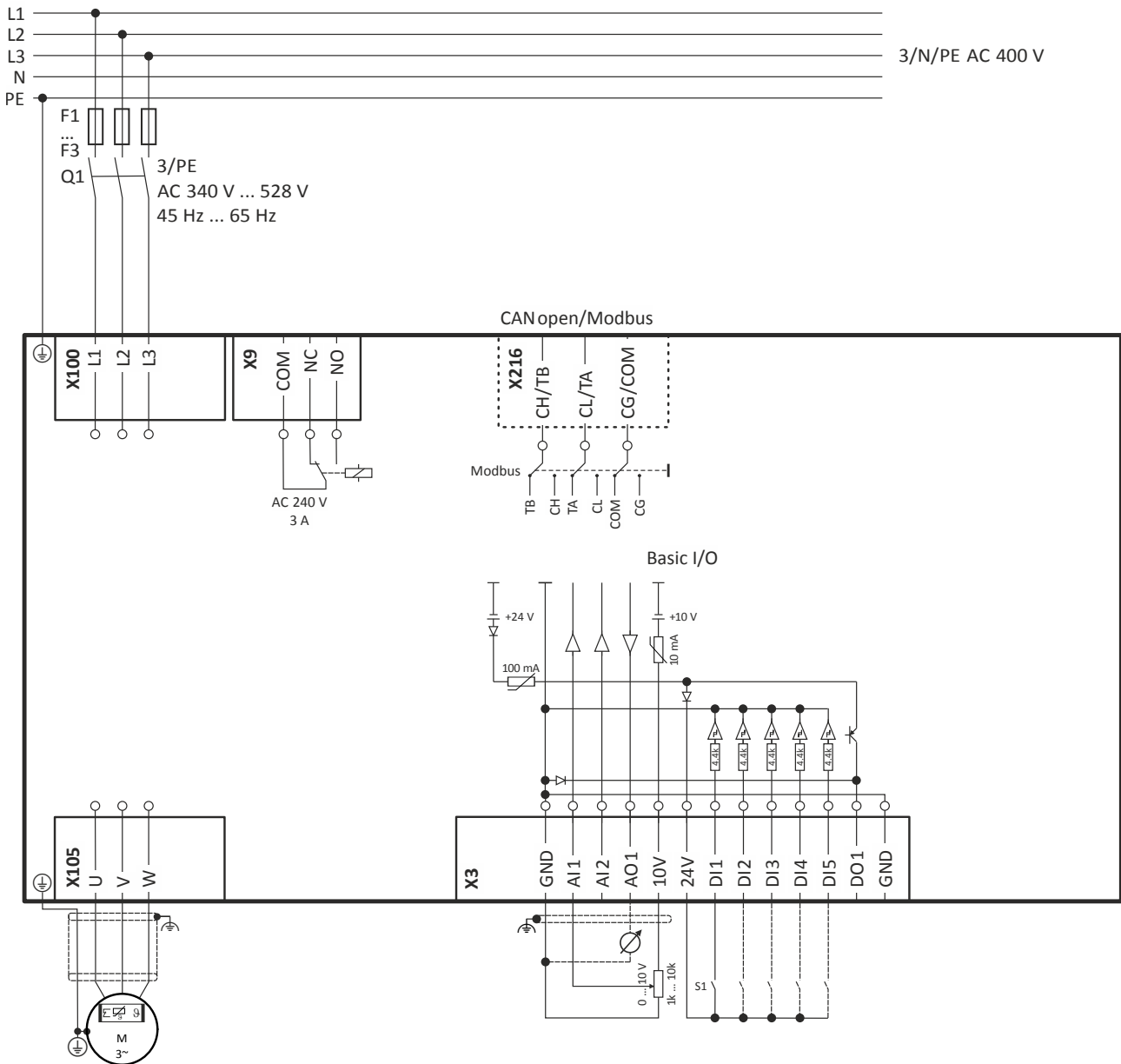

Fig. 7: Wiring example

S1 Start/Stop
Fx Fuses

Q1 Mains contactor
--- Dashed line = options

3-phase mains connection 400 V "Light Duty"

See "3-phase mains connection 400 V". [44](#)



Information on electrical installation

Mains connection
3-phase mains connection 480 V "Light Duty"

3-phase mains connection 480 V

The connection plan is valid for the inverters i510-Cxxx/400-3.

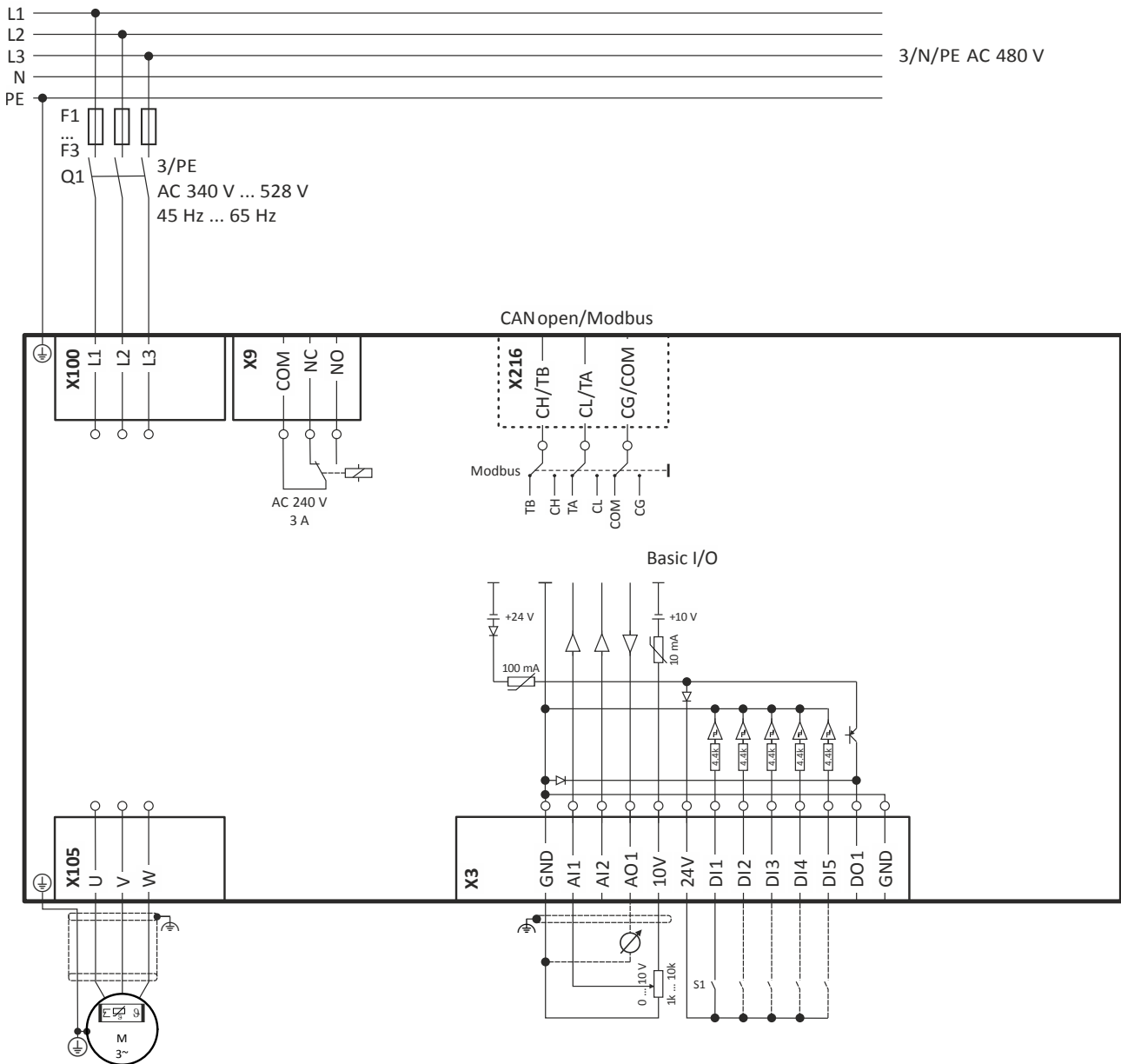

Fig. 8: Wiring example

S1 Start/Stop
Fx Fuses

Q1 Mains contactor
--- Dashed line = options

3-phase mains connection 480 V "Light Duty"

See "3-phase mains connection 480 V". [45](#)



Motor connection

Switching in the motor cable



Switching on the motor side of the inverter is permissible:

For safety shutdown (emergency stop).

In case several motors are driven by one inverter (only in V/f operating mode).

Please note the following:

The switching elements on the motor side must be dimensioned for with the maximum occurring load.

Motor cable lengths

- The rated data for the motor cable length must be observed.
- Keep the motor cable as short as possible as this has a positive effect on the drive behaviour and the EMC.
- Several motors connected to an inverter form a group drive.
In case of group drives, the resulting motor cable length l_{res} is relevant:

$$l_{res} [m] = (l_1 + l_2 + l_3 \dots l_i) \cdot \sqrt{i}$$

l_{res} Resulting length of the motor cables

l_x Length of the single motor cable

i Number of the single motor cables

Shielding

A good shield connection and short cable lengths reduce possible interferences caused by problems with the EMC.

Example for preparing the EMC-compliant wiring or the motor cable

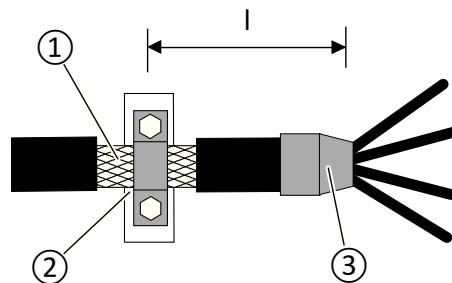

Fig. 9: Shield connection

- | | | | |
|---|---------------------------------------|---|----------------------|
| ① | Braid | ③ | Heat-shrinkable tube |
| ② | Large surface contacting of the braid | l | Maximally 500 mm |



Connection to the IT system

I51AE125x, I51AE137x



I51AE155x, I51AE175x, I51AE211x, I51AE215x, I51AE222x



I51AE230x, I51AE240x, I51AE255x, I51AE275x, I51AE311x

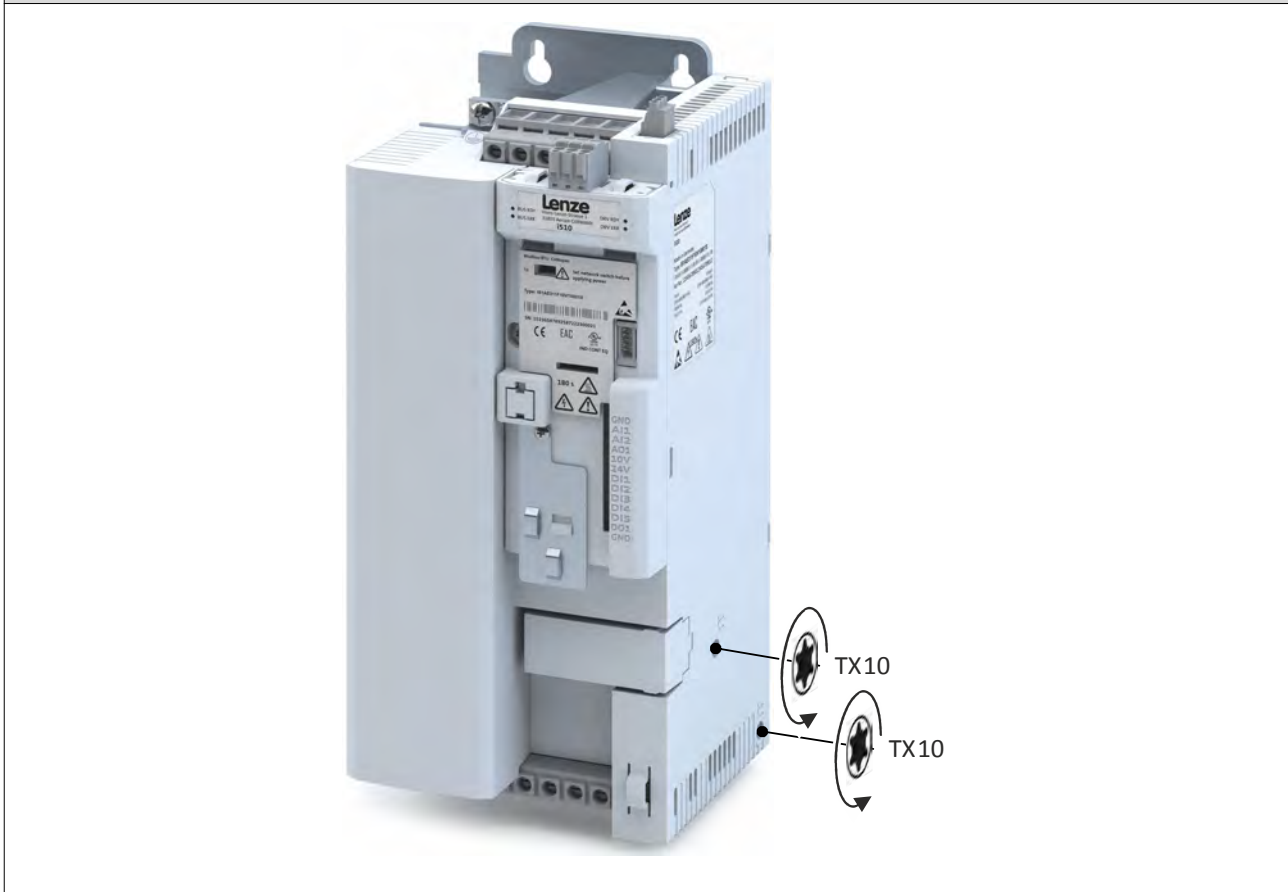

Information on electrical installation

Control connections



Control connections

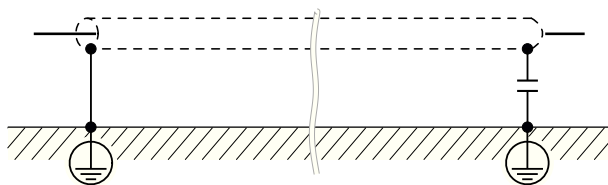

Terminal description		Control terminals
Connection		X3
Connection type		Spring terminal
Max. Cable cross-section	mm ²	1.5
Max. Cable cross-section	AWG	16
Stripping length	mm	9
Stripping length	inch	0.35
Tightening torque	Nm	-
Tightening torque	lb-in	-
Required tool		0.4 x 2.5



Networks

CANopen/Modbus

Typical topologies

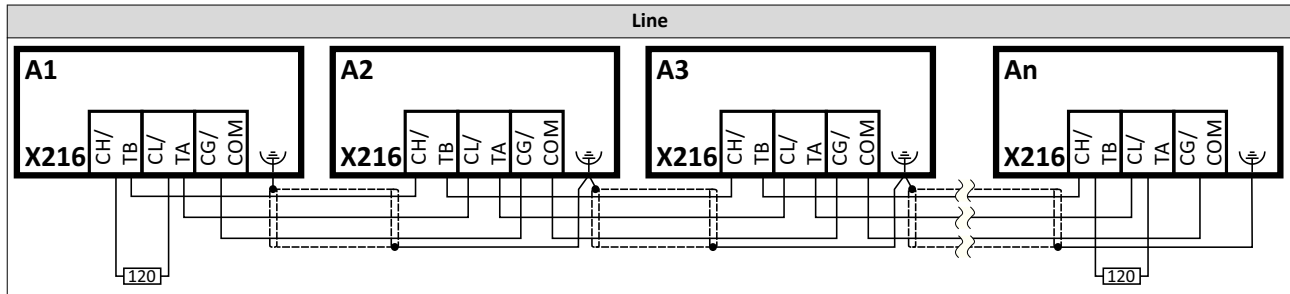

Terminal description		CANopen/Modbus	
Connection		X216	
Connection type		pluggable double spring terminal	
Max. Cable cross-section	mm ²	2.5	
Max. Cable cross-section	AWG	12	
Stripping length	mm	10	
Stripping length	inch	0.39	
Tightening torque	Nm	-	
Tightening torque	lb-in	-	
Required tool		0.4 x 2.5	

BACnet

Typical topologies

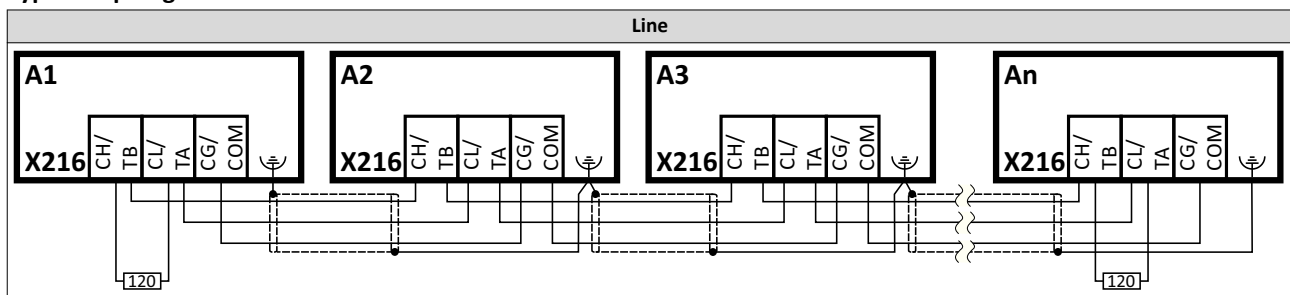

Terminal description		BACnet MS/TP	
Connection		X216	
Connection type		pluggable double spring terminal	
Max. Cable cross-section	mm ²	2.5	
Max. Cable cross-section	AWG	12	
Stripping length	mm	10	
Stripping length	inch	0.39	
Tightening torque	Nm	-	
Tightening torque	lb-in	-	
Required tool		0.4 x 2.5	

Technical data

EMC data



Technical data

Standards and operating conditions

Conformities/approvals

Conformity		
CE	2014/35/EU	Low-Voltage Directive
	2014/30/EU	EMC Directive (reference: CE-typical drive system)
EAC	TR CU 004/2011	Eurasian conformity: Safety of low voltage equipment
	TR CU 020/2011	Eurasian conformity: Electromagnetic compatibility of technical means
RoHS	2011/65/EU	Restrictions for the use of specific hazardous materials in electric and electronic devices
Approval		
UL	UL 61800-5-1	for USA and Canada (requirements of the CSA 22.2 No. 274) File No. E132659

Protection of persons and device protection

Degree of protection		
IP20	EN 60529	Information applies to the mounted and ready-for-use state. It does not apply to the wire range of the terminals
	NEMA 250	only protection against accidental contact acc. to type 1
Open type		Only in UL-approved systems
Insulation resistance		
Overvoltage category III	EN 61800-5-1	0 ... 2000 m a.m.s.l.
Overvoltage category II	EN 61800-5-1	above 2000 m a.m.s.l.
Control circuit isolation		
Safe mains isolation by double/reinforced insulation	EN 61800-5-1	
Protective measures against		
Short circuit		
Earth fault		Earth fault strength depends on the operating status
Motor overtemperature		I ² t monitoring
Overvoltage		
Motor stalling		
Leakage current		
> 3.5 mA AC, > 10 mA DC	EN 61800-5-1	Observe regulations and safety instructions!
Starting current		
≤ 3 x rated mains current		

EMC data

Actuation on public supply systems		
Implement measures to limit the radio interference to be expected:		The machine or plant manufacturer is responsible for compliance with the requirements for the machine/plant!
< 1 kW: with mains choke	EN 61000-3-2	
> 1 kW at mains current ≤ 16 A: without additional measures		
Mains current > 16 A: with mains choke or mains filter, with dimensioning for rated power.	EN 61000-3-12	
Noise emission		
Category C2	EN 61800-3	see rated data
Category C3	EN 61800-3	see rated data
Noise immunity		
Meets requirement in compliance with	EN 61800-3	



Motor connection

Requirements to the shielded motor cable		
Capacitance per unit length		
C-core-core/C-core-shield < 75/150 pF/m		≤ 2.5 mm ² / AWG 14
C-core-core/C-core-shield < 150/300 pF/m		≥ 4 mm ² / AWG 12
Electric strength		
U ₀ /U = 0.6/1.0 kV		U ₀ = r.m.s. value external conductor to PE U = r.m.s. value external conductor/external conductor
U ≥ 600 V	UL	U = r.m.s. value external conductor/external conductor

Environmental conditions

Energy efficiency		
Class IE2	EN 50598-2	
Climate		
1K3 (-25 ... +60 °C)	EN 60721-3-1	Storage
2K3 (-25 ... +70 °C)	EN 60721-3-2	Transport
3K3 (-10 ... +55 °C)	EN 60721-3-3	Operation
		Operation at a switching frequency of 2 or 4 kHz: above +45°C: reduce rated output current by 2.5 %/°C Operation at a switching frequency of 8 or 16 kHz: above +40°C: reduce rated output current by 2.5 %/°C
Site altitude		
0 ... 1000 m a.m.s.l.		
1000 ... 4000 m a.m.s.l.		Reduce rated output current by 5 %/1000 m
Pollution		
Degree of pollution 2	EN 61800-5-1 UL 61800-5-1	
Vibration resistance		
Transport		
2M2 (sine, shock)	EN 60721-3-2	in original packaging
Operation		
Amplitude 1 mm acceleration resistant up to 0.7 g	Germanischer Lloyd	5 ... 13.2 Hz 13.2 ... 100 Hz
Amplitude 0.075 mm Acceleration resistant up to 1 g	EN 61800-5-1	10 ... 57 Hz 57 ... 150 Hz

Electrical supply conditions

The connection to different supply forms enables a worldwide application of the inverters.

The following is supported:

- (Geräte: Cxxx/230-1, Cxxx/230-2) [1-phase mains connection 230/240 V](#) 52
- (Geräte: Cxxx/230-1, Cxxx/230-2) [3-phase mains connection 230/240 V](#) 69
- [3-phase mains connection 230/240 V "Light Duty"](#) 81
- ▶ [3-phase mains connection 400 V](#) 86
- [3-phase mains connection 400 V "Light Duty"](#) 99
- ▶ [3-phase mains connection 480 V](#) 107
- [3-phase mains connection 480 V "Light Duty"](#) 120

Permissible mains systems		
TT		Voltage against earth: max. 300 V
TN		Voltage against earth: max. 300 V
IT		Apply the measures described for IT systems!
		IT systems are not relevant for UL-approved systems

Technical data

1-phase mains connection 230/240 V



1-phase mains connection 230/240 V



When selecting the inverters, please note: **EMC filters** are integrated in the i510-Cxxx/230-1 inverters. **EMC filters** are not integrated in the inverters i510-Cxxx/230-2.



Rated data

The output currents apply to these operating conditions:

- At a switching frequency of 2 kHz or 4 kHz: Max. ambient temperature 45°C.
- At a switching frequency of 8 kHz or 16 kHz: Max. ambient temperature 40 °C.

Inverter		i510-C0.25/230-1	i510-C0.25/230-2	i510-C0.37/230-1	i510-C0.37/230-2
Rated power	kW	0.25	0.25	0.37	0.37
Rated power	hp	0.33	0.33	0.5	0.5
Mains voltage range		1/PE AC 170 V ... 264 V, 45 Hz ... 65 Hz			
Output voltage		3 AC 0-230/240 V			
Rated mains current					
without mains choke	A	4	4	5.7	5.7
with mains choke	A	3.6	3.6	4.8	4.8
Apparent output power	kVA	0.6	0.6	0.9	0.9
Rated output current					
2 kHz	A	-	-	-	-
4 kHz	A	1.7	1.7	2.4	2.4
8 kHz	A	1.7	1.7	2.4	2.4
16 kHz	A	1.1	1.1	1.6	1.6
Power loss					
2 kHz	W	-	-	-	-
4 kHz	W	15	15	18	18
8 kHz	W	15	15	20	20
16 kHz	W	19	19	24	24
at inverter disablecontroller inhibit	W	6	6	6	6
Overcurrent cycle 180 s					
Max. Output current	A	2.6	2.6	3.6	3.6
Overload time	s	60	60	60	60
Recovery time	s	120	120	120	120
Max. output current during the recovery time	A	1.3	1.3	1.8	1.8
Overcurrent cycle 15 s					
Max. Output current	A	3.4	3.4	4.8	4.8
Overload time	s	3	3	3	3
Recovery time	s	12	12	12	12
Max. output current during the recovery time	A	1.3	1.3	1.8	1.8
Cyclic mains switching		3 times per minute			
Brake chopper					
Max. Output current	A	-	-	-	-
Min. Brake resistor	Ω	-	-	-	-
Max. Shielded motor cable length					
Category C2 (2 kHz, 4 kHz, 8 kHz)	m	15	-	15	-
Category C3 (2 kHz, 4 kHz, 8 kHz)	m	15	-	15	-
without EMC category	m	50	50	50	50
Weight	kg	0.75	0.75	0.75	0.75
Weight	lb	1.7	1.7	1.7	1.7

Technical data

1-phase mains connection 230/240 V

Rated data



Inverter		i510-C0.55/230-1	i510-C0.55/230-2	i510-C0.75/230-1	i510-C0.75/230-2
Rated power	kW	0.55	0.55	0.75	0.75
Rated power	hp	0.75	0.75	1	1
Mains voltage range		1/PE AC 170 V ... 264 V, 45 Hz ... 65 Hz			
Output voltage		3 AC 0-230/240 V			
Rated mains current					
without mains choke	A	7.6	7.6	10	10
with mains choke	A	7.1	7.1	8.8	8.8
Apparent output power	kVA	1.2	1.2	1.6	1.6
Rated output current					
2 kHz	A	3.2	3.2	4.2	4.2
4 kHz	A	3.2	3.2	4.2	4.2
8 kHz	A	3.2	3.2	4.2	4.2
16 kHz	A	2.1	2.1	2.8	2.8
Power loss					
2 kHz	W	22	22	27	27
4 kHz	W	23	23	29	29
8 kHz	W	25	25	33	33
16 kHz	W	30	30	38	38
at inverter disablecontroller inhibit	W	6	6	6	6
Overcurrent cycle 180 s					
Max. Output current	A	4.8	4.8	6.3	6.3
Overload time	s	60	60	60	60
Recovery time	s	120	120	120	120
Max. output current during the recovery time	A	2.4	2.4	3.2	3.2
Overcurrent cycle 15 s					
Max. Output current	A	6.4	6.4	8.4	8.4
Overload time	s	3	3	3	3
Recovery time	s	12	12	12	12
Max. output current during the recovery time	A	2.4	2.4	3.2	3.2
Cyclic mains switching		3 times per minute			
Brake chopper					
Max. Output current	A	-	-	-	-
Min. Brake resistor	Ω	-	-	-	-
Max. Shielded motor cable length					
Category C2 (2 kHz, 4 kHz, 8 kHz)	m	20	-	20	-
Category C3 (2 kHz, 4 kHz, 8 kHz)	m	50	-	50	-
without EMC category	m	50	50	50	50
Weight	kg	0.95	0.95	0.95	0.95
Weight	lb	2.1	2.1	2.1	2.1



Technical data

1-phase mains connection 230/240 V
Rated data

Inverter		i510-C1.1/230-1	i510-C1.1/230-2	i510-C1.5/230-1	i510-C1.5/230-2
Rated power	kW	1.1	1.1	1.5	1.5
Rated power	hp	1.5	1.5	2	2
Mains voltage range		1/PE AC 170 V ... 264 V, 45 Hz ... 65 Hz			
Output voltage		3 AC 0-230/240 V			
Rated mains current					
without mains choke	A	14.3	14.3	16.7	16.7
with mains choke	A	11.9	11.9	13.9	13.9
Apparent output power	kVA	2.2	2.2	2.6	2.6
Rated output current					
2 kHz	A	6	6	7	7
4 kHz	A	6	6	7	7
8 kHz	A	6	6	7	7
16 kHz	A	4	4	4.7	4.7
Power loss					
2 kHz	W	36	36	41	41
4 kHz	W	37	37	43	43
8 kHz	W	42	42	50	50
16 kHz	W	51	51	59	59
at inverter disablecontroller inhibit	W	6	6	6	6
Overcurrent cycle 180 s					
Max. Output current	A	9	9	10.5	10.5
Overload time	s	60	60	60	60
Recovery time	s	120	120	120	120
Max. output current during the recovery time	A	4.5	4.5	5.3	5.3
Overcurrent cycle 15 s					
Max. Output current	A	12	12	14	14
Overload time	s	3	3	3	3
Recovery time	s	12	12	12	12
Max. output current during the recovery time	A	4.5	4.5	5.3	5.3
Cyclic mains switching		3 times per minute			
Brake chopper					
Max. Output current	A	-	-	-	-
Min. Brake resistor	Ω	-	-	-	-
Max. Shielded motor cable length					
Category C2 (2 kHz, 4 kHz, 8 kHz)	m	20	-	20	-
Category C3 (2 kHz, 4 kHz, 8 kHz)	m	35	-	35	-
without EMC category	m	50	50	50	50
Weight	kg	1.35	1.35	1.35	1.35
Weight	lb	3	3	3	3

Technical data

1-phase mains connection 230/240 V

Rated data



Inverter		i510-C2.2/230-1	i510-C2.2/230-2
Rated power	kW	2.2	2.2
Rated power	hp	3	3
Mains voltage range		1/PE AC 170 V ... 264 V, 45 Hz ... 65 Hz	
Output voltage		3 AC 0-230/240 V	
Rated mains current			
without mains choke	A	22.5	22.5
with mains choke	A	16.9	16.9
Apparent output power	kVA	3.6	3.6
Rated output current			
2 kHz	A	9.6	9.6
4 kHz	A	9.6	9.6
8 kHz	A	9.6	9.6
16 kHz	A	6.4	6.4
Power loss			
2 kHz	W	54	54
4 kHz	W	60	60
8 kHz	W	70	70
16 kHz	W	78	78
at inverter disablecontroller inhibit	W	6	6
Overcurrent cycle 180 s			
Max. Output current	A	14.4	14.4
Overload time	s	60	60
Recovery time	s	120	120
Max. output current during the recovery time	A	7.2	7.2
Overcurrent cycle 15 s			
Max. Output current	A	19.2	19.2
Overload time	s	3	3
Recovery time	s	12	12
Max. output current during the recovery time	A	7.2	7.2
Cyclic mains switching		3 times per minute	
Brake chopper			
Max. Output current	A	-	-
Min. Brake resistor	Ω	-	-
Max. Shielded motor cable length			
Category C2 (2 kHz, 4 kHz, 8 kHz)	m	20	-
Category C3 (2 kHz, 4 kHz, 8 kHz)	m	35	-
without EMC category	m	50	50
Weight	kg	1.35	1.35
Weight	lb	3	3



Fusing data

Fusing data					
Inverter		i510-C0.25/230-1	i510-C0.25/230-2	i510-C0.37/230-1	i510-C0.37/230-2
Cable installation in compliance with		EN 60204-1			
without mains choke					
Circuit breaker		B			
Characteristics		B			
Max. Rated current	A	10	10	10	10
Fuse		gG/gL or gRL			
Characteristics		gG/gL or gRL			
Max. Rated current	A	10	10	10	10
with mains choke					
Circuit breaker		B			
Characteristics		B			
Max. Rated current	A	10	10	10	10
Fuse		gG/gL or gRL			
Characteristics		gG/gL or gRL			
Max. Rated current	A	10	10	10	10
Earth-leakage circuit breaker					
1-phase mains connection		≥ 30 mA, type A or B			

Fusing data					
Inverter		i510-C0.55/230-1	i510-C0.55/230-2	i510-C0.75/230-1	i510-C0.75/230-2
Cable installation in compliance with		EN 60204-1			
without mains choke					
Circuit breaker		B			
Characteristics		B			
Max. Rated current	A	16	16	16	16
Fuse		gG/gL or gRL			
Characteristics		gG/gL or gRL			
Max. Rated current	A	16	16	16	16
with mains choke					
Circuit breaker		B			
Characteristics		B			
Max. Rated current	A	16	16	16	16
Fuse		gG/gL or gRL			
Characteristics		gG/gL or gRL			
Max. Rated current	A	16	16	16	16
Earth-leakage circuit breaker					
1-phase mains connection		≥ 30 mA, type A or B			

Technical data

1-phase mains connection 230/240 V

Fusing data



Fusing data					
Inverter		i510-C1.1/230-1	i510-C1.1/230-2	i510-C1.5/230-1	i510-C1.5/230-2
Cable installation in compliance with		EN 60204-1			
without mains choke					
Circuit breaker					
Characteristics		B			
Max. Rated current	A	25	25	25	25
Fuse					
Characteristics		gG/gL or gRL			
Max. Rated current	A	25	25	25	25
with mains choke					
Circuit breaker					
Characteristics		B			
Max. Rated current	A	25	25	25	25
Fuse					
Characteristics		gG/gL or gRL			
Max. Rated current	A	25	25	25	25
Earth-leakage circuit breaker					
1-phase mains connection		≥ 30 mA, type A or B			

Fusing data			
Inverter		i510-C2.2/230-1	i510-C2.2/230-2
Cable installation in compliance with		EN 60204-1	
without mains choke			
Circuit breaker			
Characteristics		B	
Max. Rated current	A	25	25
Fuse			
Characteristics		gG/gL or gRL	
Max. Rated current	A	25	25
with mains choke			
Circuit breaker			
Characteristics		B	
Max. Rated current	A	25	25
Fuse			
Characteristics		gG/gL or gRL	
Max. Rated current	A	25	25
Earth-leakage circuit breaker			
1-phase mains connection		≥ 30 mA, type A or B	



The values given below refer to the minimum SCCR values. The actual possible values for the UL fuse data (High SCCR) can be found in the appendix at: [▶ UL fuses \(High SCCR\)](#) [□ 153](#)

Fusing data					
Inverter		i510-C0.25/230-1	i510-C0.25/230-2	i510-C0.37/230-1	i510-C0.37/230-2
Cable installation in compliance with		US National Electrical Code NFPA 70 / Canadian Electrical Code C22.1			
without mains choke					
Circuit breaker					
Characteristics		all acc. to UL 489			
Max. Rated current	A	15	15	15	15
Fusing type		Standard fusing			
SCCR: Requirement		Standard short-circuit strength			
SCCR: Max. Short-circuit current	kA	5	5	5	5
SCCR: Voltage		240 Volts Maximum			
Fuse					
Characteristics		all acc. to UL 248 / Class CC			
Max. Rated current	A	15	15	15	15
Fusing type		Standard fusing			
SCCR: Requirement		Standard short-circuit strength			
SCCR: Max. Short-circuit current	kA	5	5	5	5
SCCR: Voltage		240 Volts Maximum			
with mains choke					
Circuit breaker					
Characteristics		all acc. to UL 489			
Max. Rated current	A	15	15	15	15
Fusing type		Standard fusing			
SCCR: Requirement		Standard short-circuit strength			
SCCR: Max. Short-circuit current	kA	5	5	5	5
SCCR: Voltage		240 Volts Maximum			
Fuse					
Characteristics		all acc. to UL 248 / Class CC			
Max. Rated current	A	15	15	15	15
Fusing type		Standard fusing			
SCCR: Requirement		Standard short-circuit strength			
SCCR: Max. Short-circuit current	kA	5	5	5	5
SCCR: Voltage		240 Volts Maximum			
Earth-leakage circuit breaker					
1-phase mains connection		≥ 30 mA, type A or B			

Technical data

1-phase mains connection 230/240 V
Fusing data



Fusing data					
Inverter		i510-C0.55/230-1	i510-C0.55/230-2	i510-C0.75/230-1	i510-C0.75/230-2
Cable installation in compliance with		US National Electrical Code NFPA 70 / Canadian Electrical Code C22.1			
without mains choke					
Circuit breaker					
Characteristics		all acc. to UL 489			
Max. Rated current	A	15	15	15	15
Fusing type		Standard fusing			
SCCR: Requirement		Standard short-circuit strength			
SCCR: Max. Short-circuit current	kA	5	5	5	5
SCCR: Voltage		240 Volts Maximum			
Fuse					
Characteristics		all acc. to UL 248 / Class CC			
Max. Rated current	A	15	15	15	15
Fusing type		Standard fusing			
SCCR: Requirement		Standard short-circuit strength			
SCCR: Max. Short-circuit current	kA	5	5	5	5
SCCR: Voltage		240 Volts Maximum			
with mains choke					
Circuit breaker					
Characteristics		all acc. to UL 489			
Max. Rated current	A	15	15	15	15
Fusing type		Standard fusing			
SCCR: Requirement		Standard short-circuit strength			
SCCR: Max. Short-circuit current	kA	5	5	5	5
SCCR: Voltage		240 Volts Maximum			
Fuse					
Characteristics		all acc. to UL 248 / Class CC			
Max. Rated current	A	15	15	15	15
Fusing type		Standard fusing			
SCCR: Requirement		Standard short-circuit strength			
SCCR: Max. Short-circuit current	kA	5	5	5	5
SCCR: Voltage		240 Volts Maximum			
Earth-leakage circuit breaker					
1-phase mains connection		≥ 30 mA, type A or B			



Technical data

1-phase mains connection 230/240 V
Fusing data

Fusing data					
Inverter		i510-C1.1/230-1	i510-C1.1/230-2	i510-C1.5/230-1	i510-C1.5/230-2
Cable installation in compliance with		US National Electrical Code NFPA 70 / Canadian Electrical Code C22.1			
without mains choke					
Circuit breaker					
Characteristics		all acc. to UL 489			
Max. Rated current	A	30	30	30	30
Fusing type		Standard fusing			
SCCR: Requirement		Standard short-circuit strength			
SCCR: Max. Short-circuit current	kA	5	5	5	5
SCCR: Voltage		240 Volts Maximum			
Fuse					
Characteristics		all acc. to UL 248 / Class CC			
Max. Rated current	A	30	30	30	30
Fusing type		Standard fusing			
SCCR: Requirement		Standard short-circuit strength			
SCCR: Max. Short-circuit current	kA	5	5	5	5
SCCR: Voltage		240 Volts Maximum			
with mains choke					
Circuit breaker					
Characteristics		all acc. to UL 489			
Max. Rated current	A	30	30	30	30
Fusing type		Standard fusing			
SCCR: Requirement		Standard short-circuit strength			
SCCR: Max. Short-circuit current	kA	5	5	5	5
SCCR: Voltage		240 Volts Maximum			
Fuse					
Characteristics		all acc. to UL 248 / Class CC			
Max. Rated current	A	30	30	30	30
Fusing type		Standard fusing			
SCCR: Requirement		Standard short-circuit strength			
SCCR: Max. Short-circuit current	kA	5	5	5	5
SCCR: Voltage		240 Volts Maximum			
Earth-leakage circuit breaker					
1-phase mains connection		≥ 30 mA, type A or B			

Technical data

1-phase mains connection 230/240 V
Fusing data



Fusing data			
Inverter		i510-C2.2/230-1	i510-C2.2/230-2
Cable installation in compliance with		US National Electrical Code NFPA 70 / Canadian Electrical Code C22.1	
without mains choke			
Circuit breaker			
Characteristics		all acc. to UL 489	
Max. Rated current	A	30	30
Fusing type		Standard fusing	
SCCR: Requirement		Standard short-circuit strength	
SCCR: Max. Short-circuit current	kA	5	5
SCCR: Voltage		240 Volts Maximum	
Fuse			
Characteristics		all acc. to UL 248 / Class CC	
Max. Rated current	A	30	30
Fusing type		Standard fusing	
SCCR: Requirement		Standard short-circuit strength	
SCCR: Max. Short-circuit current	kA	5	5
SCCR: Voltage		240 Volts Maximum	
with mains choke			
Circuit breaker			
Characteristics		all acc. to UL 489	
Max. Rated current	A	30	30
Fusing type		Standard fusing	
SCCR: Requirement		Standard short-circuit strength	
SCCR: Max. Short-circuit current	kA	5	5
SCCR: Voltage		240 Volts Maximum	
Fuse			
Characteristics		all acc. to UL 248 / Class CC	
Max. Rated current	A	30	30
Fusing type		Standard fusing	
SCCR: Requirement		Standard short-circuit strength	
SCCR: Max. Short-circuit current	kA	5	5
SCCR: Voltage		240 Volts Maximum	
Earth-leakage circuit breaker			
1-phase mains connection		≥ 30 mA, type A or B	



Technical data

1-phase mains connection 230/240 V
Terminal data

Terminal data

Mains connection					
Inverter		i510-C0.25/230-1	i510-C0.25/230-2	i510-C0.37/230-1	i510-C0.37/230-2
Connection		X100			
Connection type		pluggable screw terminal			
Max. Cable cross-section	mm ²	2.5	2.5	2.5	2.5
Max. Cable cross-section	AWG	12	12	12	12
Stripping length	mm	8	8	8	8
Stripping length	inch	0.32	0.32	0.32	0.32
Tightening torque	Nm	0.5	0.5	0.5	0.5
Tightening torque	lb-in	4.4	4.4	4.4	4.4
Required tool		0.5 x 3.0			

Mains connection					
Inverter		i510-C0.55/230-1	i510-C0.55/230-2	i510-C0.75/230-1	i510-C0.75/230-2
Connection		X100			
Connection type		pluggable screw terminal			
Max. Cable cross-section	mm ²	2.5	2.5	2.5	2.5
Max. Cable cross-section	AWG	12	12	12	12
Stripping length	mm	8	8	8	8
Stripping length	inch	0.32	0.32	0.32	0.32
Tightening torque	Nm	0.5	0.5	0.5	0.5
Tightening torque	lb-in	4.4	4.4	4.4	4.4
Required tool		0.5 x 3.0			

Mains connection					
Inverter		i510-C1.1/230-1	i510-C1.1/230-2	i510-C1.5/230-1	i510-C1.5/230-2
Connection		X100			
Connection type		pluggable screw terminal			
Max. Cable cross-section	mm ²	6	6	6	6
Max. Cable cross-section	AWG	10	10	10	10
Stripping length	mm	8	8	8	8
Stripping length	inch	0.32	0.32	0.32	0.32
Tightening torque	Nm	0.7	0.7	0.7	0.7
Tightening torque	lb-in	6.2	6.2	6.2	6.2
Required tool		0.6 x 3.5			

Mains connection					
Inverter		i510-C2.2/230-1		i510-C2.2/230-2	
Connection		X100			
Connection type		pluggable screw terminal			
Max. Cable cross-section	mm ²	6		6	
Max. Cable cross-section	AWG	10		10	
Stripping length	mm	8		8	
Stripping length	inch	0.32		0.32	
Tightening torque	Nm	0.7		0.7	
Tightening torque	lb-in	6.2		6.2	
Required tool		0.6 x 3.5			

Technical data

1-phase mains connection 230/240 V

Terminal data



PE connection					
Inverter		i510-C0.25/230-1	i510-C0.25/230-2	i510-C0.37/230-1	i510-C0.37/230-2
Connection		PE			
Connection type		PE screw			
Max. Cable cross-section	mm ²	6	6	6	6
Max. Cable cross-section	AWG	10	10	10	10
Stripping length	mm	10	10	10	10
Stripping length	inch	0.39	0.39	0.39	0.39
Tightening torque	Nm	2	2	2	2
Tightening torque	lb-in	18	18	18	18
Required tool		Torx 20			

PE connection					
Inverter		i510-C0.55/230-1	i510-C0.55/230-2	i510-C0.75/230-1	i510-C0.75/230-2
Connection		PE			
Connection type		PE screw			
Max. Cable cross-section	mm ²	6	6	6	6
Max. Cable cross-section	AWG	10	10	10	10
Stripping length	mm	10	10	10	10
Stripping length	inch	0.39	0.39	0.39	0.39
Tightening torque	Nm	2	2	2	2
Tightening torque	lb-in	18	18	18	18
Required tool		Torx 20			

PE connection					
Inverter		i510-C1.1/230-1	i510-C1.1/230-2	i510-C1.5/230-1	i510-C1.5/230-2
Connection		PE			
Connection type		PE screw			
Max. Cable cross-section	mm ²	6	6	6	6
Max. Cable cross-section	AWG	10	10	10	10
Stripping length	mm	10	10	10	10
Stripping length	inch	0.39	0.39	0.39	0.39
Tightening torque	Nm	2	2	2	2
Tightening torque	lb-in	18	18	18	18
Required tool		Torx 20			

PE connection					
Inverter		i510-C2.2/230-1		i510-C2.2/230-2	
Connection		PE			
Connection type		PE screw			
Max. Cable cross-section	mm ²	6		6	
Max. Cable cross-section	AWG	10		10	
Stripping length	mm	10		10	
Stripping length	inch	0.39		0.39	
Tightening torque	Nm	2		2	
Tightening torque	lb-in	18		18	
Required tool		Torx 20			



Technical data

1-phase mains connection 230/240 V
Terminal data

Motor connection					
Inverter		i510-C0.25/230-1	i510-C0.25/230-2	i510-C0.37/230-1	i510-C0.37/230-2
Connection		X105			
Connection type		pluggable screw terminal			
Max. Cable cross-section	mm ²	2.5	2.5	2.5	2.5
Max. Cable cross-section	AWG	12	12	12	12
Stripping length	mm	8	8	8	8
Stripping length	inch	0.32	0.32	0.32	0.32
Tightening torque	Nm	0.5	0.5	0.5	0.5
Tightening torque	lb-in	4.4	4.4	4.4	4.4
Required tool		0.5 x 3.0			

Motor connection					
Inverter		i510-C0.55/230-1	i510-C0.55/230-2	i510-C0.75/230-1	i510-C0.75/230-2
Connection		X105			
Connection type		pluggable screw terminal			
Max. Cable cross-section	mm ²	2.5	2.5	2.5	2.5
Max. Cable cross-section	AWG	12	12	12	12
Stripping length	mm	8	8	8	8
Stripping length	inch	0.32	0.32	0.32	0.32
Tightening torque	Nm	0.5	0.5	0.5	0.5
Tightening torque	lb-in	4.4	4.4	4.4	4.4
Required tool		0.5 x 3.0			

Motor connection					
Inverter		i510-C1.1/230-1	i510-C1.1/230-2	i510-C1.5/230-1	i510-C1.5/230-2
Connection		X105			
Connection type		pluggable screw terminal			
Max. Cable cross-section	mm ²	2.5	2.5	2.5	2.5
Max. Cable cross-section	AWG	12	12	12	12
Stripping length	mm	8	8	8	8
Stripping length	inch	0.32	0.32	0.32	0.32
Tightening torque	Nm	0.5	0.5	0.5	0.5
Tightening torque	lb-in	4.4	4.4	4.4	4.4
Required tool		0.5 x 3.0			

Motor connection					
Inverter		i510-C2.2/230-1		i510-C2.2/230-2	
Connection		X105			
Connection type		pluggable screw terminal			
Max. Cable cross-section	mm ²	2.5		2.5	
Max. Cable cross-section	AWG	12		12	
Stripping length	mm	8		8	
Stripping length	inch	0.32		0.32	
Tightening torque	Nm	0.5		0.5	
Tightening torque	lb-in	4.4		4.4	
Required tool		0.5 x 3.0			

Technical data

1-phase mains connection 230/240 V
Mains chokes



Mains chokes

Inverter	Mains choke					
	Order code	Number of phases	Rated current	Inductance	Dimensions (h x w x d)	Weight
			A	mH	mm	kg
i510-C0.25/230-1	ELN1-0900H005	1	5	9	75 x 66 x 82	1.1
i510-C0.25/230-2						
i510-C0.37/230-1						
i510-C0.37/230-2						
i510-C0.55/230-1	ELN1-0500H009		9	5	75 x 66 x 82	1.1
i510-C0.55/230-2						
i510-C0.75/230-1						
i510-C0.75/230-2						
i510-C1.1/230-1	ELN1-0250H018	18	2.5	96 x 96 x 90	2.1	
i510-C1.1/230-2						
i510-C1.5/230-1						
i510-C1.5/230-2						
i510-C2.2/230-1						
i510-C2.2/230-2						



RFI filters / Mains filters

Basic information on RFI filters, mains filters and EMC: from [147](#)



EMC filters can be used both in the side structure and in the substructure.

Maximum motor cable lengths and FI operation

Mains connection			1-phase, 230 V		
Inverter			i510-C0.25/230-1 i510-C0.37/230-1	i510-C0.55/230-1 i510-C0.75/230-1	i510-C1.1/230-1 i510-C1.5/230-1 i510-C2.2/230-1
With integrated RFI filter					
Without EMC category Thermal limitation	Shielded motor cable length	m	50	50	50
	Unshielded motor cable length	m	100	100	200
With integrated RFI filter					
Category C1	Shielded motor cable length	m	-	-	-
Category C2		m	15	20	20
	Earth-leakage circuit breaker	mA	30	30	30
RFI filter Low Leakage					
Category C1	Shielded motor cable length	m	5	5	5
	Earth-leakage circuit breaker	mA	10	10	10
RFI filter Short Distance					
Category C1	Shielded motor cable length	m	25	25	25
Category C2		m	50	50	50
	Earth-leakage circuit breaker	mA	30	30	30
RFI filter Long Distance					
Category C1	Shielded motor cable length	m	50	50	50
Category C2		m	50	50	50
	Earth-leakage circuit breaker	mA	300	300	300

Low Leakage

Inverter	RFI filter		
	Order code	Dimensions (h x w x d)	Weight
		mm	kg
i510-C0.25/230-1	IOFAE137B100L0000S	226 x 60 x 50	0.85
i510-C0.37/230-1			
i510-C0.55/230-1	IOFAE175B100L0000S	276 x 60 x 50	1
i510-C0.75/230-1			
i510-C1.1/230-1	IOFAE222B100L0000S	346 x 60 x 50	1.4
i510-C1.5/230-1			
i510-C2.2/230-1			

Technical data

1-phase mains connection 230/240 V
RFI filters / Mains filters



Short Distance

Inverter	RFI filter		
	Order code	Dimensions (h x w x d)	Weight
		mm	kg
i510-C0.25/230-1	IOFAE175B100S0000S	276 x 60 x 50	0.85
i510-C0.37/230-1			
i510-C0.55/230-1			
i510-C0.75/230-1			
i510-C1.1/230-1	IOFAE222B100S0000S	346 x 60 x 50	1.2
i510-C1.5/230-1			
i510-C2.2/230-1			

Long Distance

Inverter	RFI filter		
	Order code	Dimensions (h x w x d)	Weight
		mm	kg
i510-C0.25/230-1	IOFAE175B100D0000S	276 x 60 x 50	0.85
i510-C0.37/230-1			
i510-C0.55/230-1			
i510-C0.75/230-1			
i510-C1.1/230-1	IOFAE222B100D0000S	346 x 60 x 50	1.2
i510-C1.5/230-1			
i510-C2.2/230-1			



3-phase mains connection 230/240 V



EMC filters are **not integrated** in inverters for this mains connection.

Technical data

3-phase mains connection 230/240 V

Rated data



Rated data

The output currents apply to these operating conditions:

- At a switching frequency of 2 kHz or 4 kHz: Max. ambient temperature 45°C.
- At a switching frequency of 8 kHz or 16 kHz: Max. ambient temperature 40 °C.

Inverter		i510-C0.25/230-2	i510-C0.37/230-2	i510-C0.55/230-2	i510-C0.75/230-2
Rated power	kW	0.25	0.37	0.55	0.75
Rated power	hp	0.33	0.5	0.75	1
Mains voltage range		3/PE AC 170 V ... 264 V, 45 Hz ... 65 Hz			
Output voltage		3 AC 0-230/240 V			
Rated mains current					
without mains choke	A	2.6	3.9	4.8	6.4
with mains choke	A	2	3	3.8	5.1
Apparent output power	kVA	0.6	0.9	1.2	1.6
Rated output current					
2 kHz	A	-	-	3.2	4.2
4 kHz	A	1.7	2.4	3.2	4.2
8 kHz	A	1.7	2.4	3.2	4.2
16 kHz	A	1.1	1.6	2.1	2.8
Power loss					
2 kHz	W	-	-	22	27
4 kHz	W	15	18	23	29
8 kHz	W	15	20	25	33
16 kHz	W	19	24	30	38
at inverter disablecontroller inhibit	W	6	6	6	6
Overcurrent cycle 180 s					
Max. Output current	A	2.6	3.6	4.8	6.3
Overload time	s	60	60	60	60
Recovery time	s	120	120	120	120
Max. output current during the recovery time	A	1.3	1.8	2.4	3.2
Overcurrent cycle 15 s					
Max. Output current	A	3.4	4.8	6.4	8.4
Overload time	s	3	3	3	3
Recovery time	s	12	12	12	12
Max. output current during the recovery time	A	1.3	1.8	2.4	3.2
Cyclic mains switching		3 times per minute			
Brake chopper					
Max. Output current	A	-	-	-	-
Min. Brake resistor	Ω	-	-	-	-
Max. Shielded motor cable length					
Category C2 (2 kHz, 4 kHz, 8 kHz)	m	-	-	-	-
Category C3 (2 kHz, 4 kHz, 8 kHz)	m	-	-	-	-
without EMC category	m	50	50	50	50
Weight	kg	0.75	0.75	0.95	0.95
Weight	lb	1.7	1.7	2.1	2.1



Technical data

3-phase mains connection 230/240 V
Rated data

Inverter		i510-C1.1/230-2	i510-C1.5/230-2	i510-C2.2/230-2	i510-C4.0/230-3
Rated power	kW	1.1	1.5	2.2	4
Rated power	hp	1.5	2	3	5
Mains voltage range		3/PE AC 170 V ... 264 V, 45 Hz ... 65 Hz			
Output voltage		3 AC 0-230/240 V			
Rated mains current					
without mains choke	A	7.8	9.5	13.6	20.6
with mains choke	A	5.6	6.8	9.8	15.7
Apparent output power	kVA	2.2	2.6	3.6	6.4
Rated output current					
2 kHz	A	6	7	9.6	16.5
4 kHz	A	6	7	9.6	16.5
8 kHz	A	6	7	9.6	16.5
16 kHz	A	4	4.7	6.4	11
Power loss					
2 kHz	W	36	41	54	113
4 kHz	W	37	43	60	115
8 kHz	W	42	50	70	130
16 kHz	W	51	59	78	116
at inverter disablecontroller inhibit	W	6	6	6	6
Overcurrent cycle 180 s					
Max. Output current	A	9	10.5	14.4	24.8
Overload time	s	60	60	60	60
Recovery time	s	120	120	120	120
Max. output current during the recovery time	A	4.5	5.3	7.2	12.4
Overcurrent cycle 15 s					
Max. Output current	A	12	14	19.2	33
Overload time	s	3	3	3	3
Recovery time	s	12	12	12	12
Max. output current during the recovery time	A	4.5	5.3	7.2	12.4
Cyclic mains switching		3 times per minute			
Brake chopper					
Max. Output current	A	-	-	-	-
Min. Brake resistor	Ω	-	-	-	-
Max. Shielded motor cable length					
Category C2 (2 kHz, 4 kHz, 8 kHz)	m	-	-	-	-
Category C3 (2 kHz, 4 kHz, 8 kHz)	m	-	-	-	-
without EMC category	m	50	50	50	50
Weight	kg	1.35	1.35	1.35	2.1
Weight	lb	3	3	3	4.6

Technical data

3-phase mains connection 230/240 V

Rated data



Inverter		i510-C5.5/230-3
Rated power	kW	5.5
Rated power	hp	7.5
Mains voltage range		3/PE AC 170 V ... 264 V, 45 Hz ... 65 Hz
Output voltage		3 AC 0-230/240 V
Rated mains current		
without mains choke	A	28.8
with mains choke	A	21.9
Apparent output power	kVA	8.7
Rated output current		
2 kHz	A	23
4 kHz	A	23
8 kHz	A	23
16 kHz	A	15.3
Power loss		
2 kHz	W	166
4 kHz	W	175
8 kHz	W	195
16 kHz	W	159
at inverter disablecontroller inhibit	W	6
Overcurrent cycle 180 s		
Max. Output current	A	34.5
Overload time	s	60
Recovery time	s	120
Max. output current during the recovery time	A	17.3
Overcurrent cycle 15 s		
Max. Output current	A	46
Overload time	s	3
Recovery time	s	12
Max. output current during the recovery time	A	17.3
Cyclic mains switching		3 times per minute
Brake chopper		
Max. Output current	A	-
Min. Brake resistor	Ω	-
Max. Shielded motor cable length		
Category C2 (2 kHz, 4 kHz, 8 kHz)	m	-
Category C3 (2 kHz, 4 kHz, 8 kHz)	m	-
without EMC category	m	50
Weight	kg	2.1
Weight	lb	4.6



Fusing data

Fusing data					
Inverter		i510-C0.25/230-2	i510-C0.37/230-2	i510-C0.55/230-2	i510-C0.75/230-2
Cable installation in compliance with		EN 60204-1			
without mains choke					
Circuit breaker					
Characteristics		B			
Max. Rated current	A	10	10	16	16
Fuse					
Characteristics		gG/gL or gRL			
Max. Rated current	A	10	10	16	16
with mains choke					
Circuit breaker					
Characteristics		B			
Max. Rated current	A	10	10	16	16
Fuse					
Characteristics		gG/gL or gRL			
Max. Rated current	A	10	10	16	16
Earth-leakage circuit breaker					
3-phase mains connection		≥ 30 mA, type B			

Fusing data					
Inverter		i510-C1.1/230-2	i510-C1.5/230-2	i510-C2.2/230-2	i510-C4.0/230-3
Cable installation in compliance with		EN 60204-1			
without mains choke					
Circuit breaker					
Characteristics		B			
Max. Rated current	A	25	25	25	32
Fuse					
Characteristics		gG/gL or gRL			
Max. Rated current	A	25	25	25	32
with mains choke					
Circuit breaker					
Characteristics		B			
Max. Rated current	A	25	25	25	32
Fuse					
Characteristics		gG/gL or gRL			
Max. Rated current	A	25	25	25	32
Earth-leakage circuit breaker					
3-phase mains connection		≥ 30 mA, type B			≥ 300 mA, type B

Technical data

3-phase mains connection 230/240 V

Fusing data



Fusing data		
Inverter		i510-C5.5/230-3
Cable installation in compliance with		EN 60204-1
without mains choke		
Circuit breaker		
Characteristics		B
Max. Rated current	A	32
Fuse		
Characteristics		gG/gL or gRL
Max. Rated current	A	32
with mains choke		
Circuit breaker		
Characteristics		B
Max. Rated current	A	32
Fuse		
Characteristics		gG/gL or gRL
Max. Rated current	A	32
Earth-leakage circuit breaker		
3-phase mains connection		≥ 300 mA, type B



The values given below refer to the minimum SCCR values. The actual possible values for the UL fuse data (High SCCR) can be found in the appendix at: [▶ UL fuses \(High SCCR\)](#) [□ 153](#)

Fusing data					
Inverter		i510-C0.25/230-2	i510-C0.37/230-2	i510-C0.55/230-2	i510-C0.75/230-2
Cable installation in compliance with		US National Electrical Code NFPA 70 / Canadian Electrical Code C22.1			
without mains choke					
Circuit breaker					
Characteristics		all acc. to UL 489			
Max. Rated current	A	15	15	15	15
Fusing type		Standard fusing			
SCCR: Requirement		Standard short-circuit strength			
SCCR: Max. Short-circuit current	kA	5	5	5	5
SCCR: Voltage		240 Volts Maximum			
Fuse					
Characteristics		all acc. to UL 248 / Class CC			
Max. Rated current	A	15	15	15	15
Fusing type		Standard fusing			
SCCR: Requirement		Standard short-circuit strength			
SCCR: Max. Short-circuit current	kA	5	5	5	5
SCCR: Voltage		240 Volts Maximum			
with mains choke					
Circuit breaker					
Characteristics		all acc. to UL 489			
Max. Rated current	A	15	15	15	15
Fusing type		Standard fusing			
SCCR: Requirement		Standard short-circuit strength			
SCCR: Max. Short-circuit current	kA	5	5	5	5
SCCR: Voltage		240 Volts Maximum			
Fuse					
Characteristics		all acc. to UL 248 / Class CC			
Max. Rated current	A	15	15	15	15
Fusing type		Standard fusing			
SCCR: Requirement		Standard short-circuit strength			
SCCR: Max. Short-circuit current	kA	5	5	5	5
SCCR: Voltage		240 Volts Maximum			
Earth-leakage circuit breaker					
3-phase mains connection		≥ 30 mA, type B			

Technical data

3-phase mains connection 230/240 V
Fusing data



Fusing data					
Inverter		i510-C1.1/230-2	i510-C1.5/230-2	i510-C2.2/230-2	i510-C4.0/230-3
Cable installation in compliance with		US National Electrical Code NFPA 70 / Canadian Electrical Code C22.1			
without mains choke					
Circuit breaker					
Characteristics		all acc. to UL 489			-
Max. Rated current	A	30	30	30	-
Fusing type		Standard fusing			-
SCCR: Requirement		Standard short-circuit strength			-
SCCR: Max. Short-circuit current	kA	5	5	5	-
SCCR: Voltage		240 Volts Maximum			-
Fuse					
Characteristics		all acc. to UL 248 / Class CC			all acc. to UL 248 / Class J, T, R
Max. Rated current	A	30	30	30	40
Fusing type		Standard fusing			-
SCCR: Requirement		Standard short-circuit strength			-
SCCR: Max. Short-circuit current	kA	5	5	5	5
SCCR: Voltage		240 Volts Maximum			-
with mains choke					
Circuit breaker					
Characteristics		all acc. to UL 489			-
Max. Rated current	A	30	30	30	-
Fusing type		Standard fusing			-
SCCR: Requirement		Standard short-circuit strength			-
SCCR: Max. Short-circuit current	kA	5	5	5	-
SCCR: Voltage		240 Volts Maximum			-
Fuse					
Characteristics		all acc. to UL 248 / Class CC			all acc. to UL 248 / Class J, T, R
Max. Rated current	A	30	30	30	40
Fusing type		Standard fusing			-
SCCR: Requirement		Standard short-circuit strength			-
SCCR: Max. Short-circuit current	kA	5	5	5	5
SCCR: Voltage		240 Volts Maximum			-
Earth-leakage circuit breaker					
3-phase mains connection		≥ 30 mA, type B			≥ 300 mA, type B



Technical data

3-phase mains connection 230/240 V
Fusing data

Fusing data		
Inverter		i510-C5.5/230-3
Cable installation in compliance with		US National Electrical Code NFPA 70 / Canadian Electrical Code C22.1
without mains choke		
Circuit breaker		
Characteristics		-
Max. Rated current	A	-
Fusing type		-
SCCR: Requirement		-
SCCR: Max. Short-circuit current	kA	-
SCCR: Voltage		-
Fuse		
Characteristics		all acc. to UL 248 / Class J, T, R
Max. Rated current	A	40
Fusing type		Standard fusing
SCCR: Requirement		Standard short-circuit strength
SCCR: Max. Short-circuit current	kA	5
SCCR: Voltage		240 Volts Maximum
with mains choke		
Circuit breaker		
Characteristics		-
Max. Rated current	A	-
Fusing type		-
SCCR: Requirement		-
SCCR: Max. Short-circuit current	kA	-
SCCR: Voltage		-
Fuse		
Characteristics		all acc. to UL 248 / Class J, T, R
Max. Rated current	A	40
Fusing type		Standard fusing
SCCR: Requirement		Standard short-circuit strength
SCCR: Max. Short-circuit current	kA	5
SCCR: Voltage		240 Volts Maximum
Earth-leakage circuit breaker		
3-phase mains connection		≥ 300 mA, type B

Technical data

3-phase mains connection 230/240 V
Terminal data



Terminal data

Mains connection					
Inverter		i510-C0.25/230-2	i510-C0.37/230-2	i510-C0.55/230-2	i510-C0.75/230-2
Connection		X100			
Connection type		pluggable screw terminal			
Max. Cable cross-section	mm ²	2.5	2.5	2.5	2.5
Max. Cable cross-section	AWG	12	12	12	12
Stripping length	mm	8	8	8	8
Stripping length	inch	0.32	0.32	0.32	0.32
Tightening torque	Nm	0.5	0.5	0.5	0.5
Tightening torque	lb-in	4.4	4.4	4.4	4.4
Required tool		0.5 x 3.0			

Mains connection					
Inverter		i510-C1.1/230-2	i510-C1.5/230-2	i510-C2.2/230-2	i510-C4.0/230-3
Connection		X100			
Connection type		pluggable screw terminal			Screw terminal
Max. Cable cross-section	mm ²	6	6	6	6
Max. Cable cross-section	AWG	10	10	10	8
Stripping length	mm	8	8	8	9
Stripping length	inch	0.32	0.32	0.32	0.35
Tightening torque	Nm	0.7	0.7	0.7	0.5
Tightening torque	lb-in	6.2	6.2	6.2	4.4
Required tool		0.6 x 3.5			

Mains connection					
Inverter		i510-C5.5/230-3			
Connection		X100			
Connection type		Screw terminal			
Max. Cable cross-section	mm ²	6			
Max. Cable cross-section	AWG	8			
Stripping length	mm	9			
Stripping length	inch	0.35			
Tightening torque	Nm	0.5			
Tightening torque	lb-in	4.4			
Required tool		0.6 x 3.5			

PE connection					
Inverter		i510-C0.25/230-2	i510-C0.37/230-2	i510-C0.55/230-2	i510-C0.75/230-2
Connection		PE			
Connection type		PE screw			
Max. Cable cross-section	mm ²	6	6	6	6
Max. Cable cross-section	AWG	10	10	10	10
Stripping length	mm	10	10	10	10
Stripping length	inch	0.39	0.39	0.39	0.39
Tightening torque	Nm	2	2	2	2
Tightening torque	lb-in	18	18	18	18
Required tool		Torx 20			



Technical data

3-phase mains connection 230/240 V
Terminal data

PE connection					
Inverter		i510-C1.1/230-2	i510-C1.5/230-2	i510-C2.2/230-2	i510-C4.0/230-3
Connection		PE			
Connection type		PE screw			
Max. Cable cross-section	mm ²	6	6	6	6
Max. Cable cross-section	AWG	10	10	10	10
Stripping length	mm	10	10	10	10
Stripping length	inch	0.39	0.39	0.39	0.39
Tightening torque	Nm	2	2	2	2
Tightening torque	lb-in	18	18	18	18
Required tool		Torx 20			

PE connection	
Inverter	i510-C5.5/230-3
Connection	PE
Connection type	PE screw
Max. Cable cross-section	mm ² 6
Max. Cable cross-section	AWG 10
Stripping length	mm 10
Stripping length	inch 0.39
Tightening torque	Nm 2
Tightening torque	lb-in 18
Required tool	Torx 20

Motor connection					
Inverter		i510-C0.25/230-2	i510-C0.37/230-2	i510-C0.55/230-2	i510-C0.75/230-2
Connection		X105			
Connection type		pluggable screw terminal			
Max. Cable cross-section	mm ²	2.5	2.5	2.5	2.5
Max. Cable cross-section	AWG	12	12	12	12
Stripping length	mm	8	8	8	8
Stripping length	inch	0.32	0.32	0.32	0.32
Tightening torque	Nm	0.5	0.5	0.5	0.5
Tightening torque	lb-in	4.4	4.4	4.4	4.4
Required tool		0.5 x 3.0			

Motor connection					
Inverter		i510-C1.1/230-2	i510-C1.5/230-2	i510-C2.2/230-2	i510-C4.0/230-3
Connection		X105			
Connection type		pluggable screw terminal			Screw terminal
Max. Cable cross-section	mm ²	2.5	2.5	2.5	6
Max. Cable cross-section	AWG	12	12	12	8
Stripping length	mm	8	8	8	9
Stripping length	inch	0.32	0.32	0.32	0.35
Tightening torque	Nm	0.5	0.5	0.5	0.5
Tightening torque	lb-in	4.4	4.4	4.4	4.4
Required tool		0.5 x 3.0			0.6 x 3.5

Technical data

3-phase mains connection 230/240 V
Mains chokes



Motor connection		
Inverter		i510-C5.5/230-3
Connection		X105
Connection type		Screw terminal
Max. Cable cross-section	mm ²	6
Max. Cable cross-section	AWG	8
Stripping length	mm	9
Stripping length	inch	0.35
Tightening torque	Nm	0.5
Tightening torque	lb-in	4.4
Required tool		0.6 x 3.5

Mains chokes

Inverter	Order code	Number of phases	Mains choke				
			Rated current	Inductance	Dimensions (h x w x d)	Weight	
			A	mH	mm	kg	
i510-C0.25/230-2	EZAELN3002B153	3	2	14.7	56 x 77 x 100	0.53	
i510-C0.37/230-2	EZAELN3004B742		4	7.35	60 x 95 x 115	1.31	
i510-C0.55/230-2			EZAELN3006B492	6	4.9	69 x 95 x 120	1.45
i510-C0.75/230-2	EZAELN3008B372			8	3.68	85 x 120 x 140	1.9
i510-C1.1/230-2				10	2.94		2
i510-C1.5/230-2	EZAELN3010B292		16	1.84	95 x 120 x 140	2.7	
i510-C2.2/230-2	EZAELN3016B182		25	1.18	110 x 155 x 170	5.8	
i510-C4.0/230-3	EZAELN3025B122						
i510-C5.5/230-3							



Technical data

3-phase mains connection 230/240 V "Light Duty"
Rated data

3-phase mains connection 230/240 V "Light Duty"

Rated data



EMC filters are **not integrated** in inverters for this mains connection.

Technical data

3-phase mains connection 230/240 V "Light Duty"
Rated data



The output currents apply to these operating conditions:

- At a switching frequency of 2 kHz or 4 kHz: Ambient temperature above 40 °C with a rated output current reduced by 2.5 %/°C.
- If the load characteristic "Light Duty" and the switching frequencies 8 kHz or 16 kHz are selected, only the values of the load characteristic "Heavy Duty" are reached.

Inverter		i510-C4.0/230-3	i510-C5.5/230-3
Rated power	kW	5.5	7.5
Rated power	hp	7.5	10
Mains voltage range		3/PE AC 170 V ... 264 V, 45 Hz ... 65 Hz	
Output voltage		3 AC 0-230/240 V	
Rated mains current			
without mains choke	A	25.8	-
with mains choke	A	18.9	24.2
Apparent output power	kVA	8	10.5
Rated output current			
2 kHz	A	20.6	27.6
4 kHz	A	20.6	27.6
8 kHz	A	-	-
16 kHz	A	-	-
Power loss			
2 kHz	W	124	190
4 kHz	W	131	200
8 kHz	W	-	-
16 kHz	W	-	-
at inverter disablecontroller inhibit	W	6	6
Overcurrent cycle 180 s			
Max. Output current	A	24.8	34.5
Overload time	s	60	60
Recovery time	s	120	120
Max. output current during the recovery time	A	12.4	17.3
Overcurrent cycle 15 s			
Max. Output current	A	33	46
Overload time	s	3	3
Recovery time	s	12	12
Max. output current during the recovery time	A	12.4	17.3
Cyclic mains switching		3 times per minute	
Brake chopper			
Max. Output current	A	-	-
Min. Brake resistor	Ω	-	-
Max. Shielded motor cable length			
Category C2 (2 kHz, 4 kHz, 8 kHz)	m	-	-
Category C3 (2 kHz, 4 kHz, 8 kHz)	m	-	-
without EMC category	m	50	50
Weight	kg	2.1	2.1
Weight	lb	4.6	4.6



Technical data

3-phase mains connection 230/240 V "Light Duty"
Fusing data

Fusing data

Fusing data			
Inverter		i510-C4.0/230-3	i510-C5.5/230-3
Cable installation in compliance with		EN 60204-1	
without mains choke			
Circuit breaker			
Characteristics		B	-
Max. Rated current	A	32	-
Fuse			
Characteristics		gG/gL or gRL	-
Max. Rated current	A	32	-
with mains choke			
Circuit breaker			
Characteristics		B	
Max. Rated current	A	32	32
Fuse			
Characteristics		gG/gL or gRL	
Max. Rated current	A	32	32
Earth-leakage circuit breaker			
3-phase mains connection		≥ 300 mA, type B	

Technical data

3-phase mains connection 230/240 V "Light Duty"
Fusing data



The values given below refer to the minimum SCCR values. The actual possible values for the UL fuse data (High SCCR) can be found in the appendix at: [▶ UL fuses \(High SCCR\)](#) [153](#)

Fusing data			
Inverter		i510-C4.0/230-3	i510-C5.5/230-3
Cable installation in compliance with		US National Electrical Code NFPA 70 / Canadian Electrical Code C22.1	
without mains choke			
Circuit breaker			
Characteristics			-
Max. Rated current	A	-	-
Fusing type			-
SCCR: Requirement			-
SCCR: Max. Short-circuit current	kA	-	-
SCCR: Voltage			-
Fuse			
Characteristics		all acc. to UL 248 / Class J, T, R	
Max. Rated current	A	40	-
Fusing type		Standard fusing	
SCCR: Requirement		Standard short-circuit strength	
SCCR: Max. Short-circuit current	kA	5	-
SCCR: Voltage		240 Volts Maximum	
with mains choke			
Circuit breaker			
Characteristics			-
Max. Rated current	A	-	-
Fusing type			-
SCCR: Requirement			-
SCCR: Max. Short-circuit current	kA	-	-
SCCR: Voltage			-
Fuse			
Characteristics		all acc. to UL 248 / Class J, T, R	
Max. Rated current	A	40	40
Fusing type		Standard fusing	
SCCR: Requirement		Standard short-circuit strength	
SCCR: Max. Short-circuit current	kA	5	5
SCCR: Voltage		240 Volts Maximum	
Earth-leakage circuit breaker			
3-phase mains connection		≥ 300 mA, type B	



Technical data

3-phase mains connection 230/240 V "Light Duty" Mains chokes

Terminal data

Mains connection						
Inverter		i510-C4.0/230-3			i510-C5.5/230-3	
Connection		X100				
Connection type		Screw terminal				
Max. Cable cross-section	mm ²	6			6	
Max. Cable cross-section	AWG	8			8	
Stripping length	mm	9			9	
Stripping length	inch	0.35			0.35	
Tightening torque	Nm	0.5			0.5	
Tightening torque	lb-in	4.4			4.4	
Required tool		0.6 x 3.5				

PE connection						
Inverter		i510-C4.0/230-3			i510-C5.5/230-3	
Connection		PE				
Connection type		PE screw				
Max. Cable cross-section	mm ²	6			6	
Max. Cable cross-section	AWG	10			10	
Stripping length	mm	10			10	
Stripping length	inch	0.39			0.39	
Tightening torque	Nm	2			2	
Tightening torque	lb-in	18			18	
Required tool		Torx 20				

Motor connection						
Inverter		i510-C4.0/230-3			i510-C5.5/230-3	
Connection		X105				
Connection type		Screw terminal				
Max. Cable cross-section	mm ²	6			6	
Max. Cable cross-section	AWG	8			8	
Stripping length	mm	9			9	
Stripping length	inch	0.35			0.35	
Tightening torque	Nm	0.5			0.5	
Tightening torque	lb-in	4.4			4.4	
Required tool		0.6 x 3.5				

Mains chokes

Inverter	Mains choke					
	Order code	Number of phases	Rated current	Inductance	Dimensions (h x w x d)	Weight
			A	mH	mm	kg
i510-C4.0/230-3	EZAELN3020B152	3	20	1.47	95 x 155 x 165	3.8
i510-C5.5/230-3	EZAELN3025B122		25	1.18	110 x 155 x 170	5.8

Technical data

3-phase mains connection 400 V
Rated data



3-phase mains connection 400 V

Rated data

The output currents apply to these operating conditions:

- At a switching frequency of 2 kHz or 4 kHz: Max. ambient temperature 45°C.
- At a switching frequency of 8 kHz or 16 kHz: Max. ambient temperature 40 °C.

Inverter		i510-C0.37/400-3	i510-C0.55/400-3	i510-C0.75/400-3	i510-C1.1/400-3
Rated power	kW	0.37	0.55	0.75	1.1
Rated power	hp	0.5	0.75	1	1.5
Mains voltage range		3/PE AC 340 V ... 528 V, 45 Hz ... 65 Hz			
Output voltage		3 AC 0-400/480 V			
Rated mains current					
without mains choke	A	1.8	2.5	3.3	4.4
with mains choke	A	1.4	2	2.6	3
Apparent output power	kVA	0.9	1.2	1.6	2.2
Rated output current					
2 kHz	A	-	1.8	2.4	3.2
4 kHz	A	1.3	1.8	2.4	3.2
8 kHz	A	1.3	1.8	2.4	3.2
16 kHz	A	0.9	1.2	1.6	2.1
Power loss					
2 kHz	W	-	24	30	38
4 kHz	W	20	25	32	40
8 kHz	W	24	31	40	51
16 kHz	W	24	31	40	51
at inverter disablecontroller inhibit	W	6	6	6	6
Overcurrent cycle 180 s					
Max. Output current	A	2	2.7	3.6	4.8
Overload time	s	60	60	60	60
Recovery time	s	120	120	120	120
Max. output current during the recovery time	A	1	1.4	1.8	2.4
Overcurrent cycle 15 s					
Max. Output current	A	2.6	3.6	4.8	6.4
Overload time	s	3	3	3	3
Recovery time	s	12	12	12	12
Max. output current during the recovery time	A	1	1.4	1.8	2.4
Cyclic mains switching		3 times per minute			
Brake chopper					
Max. Output current	A	-	-	-	-
Min. Brake resistor	Ω	-	-	-	-
Max. Shielded motor cable length					
Category C2 (2 kHz, 4 kHz, 8 kHz)	m	15	15	15	20
Category C3 (2 kHz, 4 kHz, 8 kHz)	m	15	20	20	35
without EMC category	m	15	50	50	50
Weight	kg	0.75	0.95	0.95	1.35
Weight	lb	1.7	2.1	2.1	3



Technical data

3-phase mains connection 400 V
Rated data

Inverter		i510-C1.5/400-3	i510-C2.2/400-3	i510-C3.0/400-3	i510-C4.0/400-3
Rated power	kW	1.5	2.2	3	4
Rated power	hp	2	3	4	5
Mains voltage range		3/PE AC 340 V ... 528 V, 45 Hz ... 65 Hz			
Output voltage		3 AC 0-400/480 V			
Rated mains current					
without mains choke	A	5.4	7.8	9.6	12.5
with mains choke	A	3.7	5.3	6.9	9
Apparent output power	kVA	2.6	3.8	4.9	6.4
Rated output current					
2 kHz	A	3.9	5.6	7.3	9.5
4 kHz	A	3.9	5.6	7.3	9.5
8 kHz	A	3.9	5.6	7.3	9.5
16 kHz	A	2.6	3.7	4.9	6.3
Power loss					
2 kHz	W	45	62	79	102
4 kHz	W	48	66	85	110
8 kHz	W	61	85	110	140
16 kHz	W	61	85	109	140
at inverter disablecontroller inhibit	W	6	6	6	6
Overcurrent cycle 180 s					
Max. Output current	A	5.9	8.4	11	14.3
Overload time	s	60	60	60	60
Recovery time	s	120	120	120	120
Max. output current during the recovery time	A	2.9	4.2	5.5	7.1
Overcurrent cycle 15 s					
Max. Output current	A	7.8	11.2	14.6	19
Overload time	s	3	3	3	3
Recovery time	s	12	12	12	12
Max. output current during the recovery time	A	2.9	4.2	5.5	7.1
Cyclic mains switching		3 times per minute			
Brake chopper					
Max. Output current	A	-	-	-	-
Min. Brake resistor	Ω	-	-	-	-
Max. Shielded motor cable length					
Category C2 (2 kHz, 4 kHz, 8 kHz)	m	20	20	20	20
Category C3 (2 kHz, 4 kHz, 8 kHz)	m	35	35	35	35
without EMC category	m	50	50	100	100
Weight	kg	1.35	1.35	2.3	2.3
Weight	lb	3	3	5	5

Technical data

3-phase mains connection 400 V

Rated data



Inverter		i510-C5.5/400-3	i510-C7.5/400-3	i510-C11/400-3
Rated power	kW	5.5	7.5	11
Rated power	hp	7.5	10	15
Mains voltage range		3/PE AC 340 V ... 528 V, 45 Hz ... 65 Hz		
Output voltage		3 AC 0-400/480 V		
Rated mains current				
without mains choke	A	17.2	20	28.4
with mains choke	A	12.4	15.7	22.3
Apparent output power	kVA	8.7	11	16
Rated output current				
2 kHz	A	13	16.5	23.5
4 kHz	A	13	16.5	23.5
8 kHz	A	13	16.5	23.5
16 kHz	A	8.7	11	15.7
Power loss				
2 kHz	W	137	172	242
4 kHz	W	145	185	260
8 kHz	W	190	240	340
16 kHz	W	189	238	337
at inverter disablecontroller inhibit	W	6	6	6
Overcurrent cycle 180 s				
Max. Output current	A	19.5	25	35
Overload time	s	60	60	60
Recovery time	s	120	120	120
Max. output current during the recovery time	A	9.8	12.4	17.6
Overcurrent cycle 15 s				
Max. Output current	A	26	33	47
Overload time	s	3	3	3
Recovery time	s	12	12	12
Max. output current during the recovery time	A	9.8	12.4	17.6
Cyclic mains switching		3 times per minute		
Brake chopper				
Max. Output current	A	-	-	-
Min. Brake resistor	Ω	-	-	-
Max. Shielded motor cable length				
Category C2 (2 kHz, 4 kHz, 8 kHz)	m	20	20	20
Category C3 (2 kHz, 4 kHz, 8 kHz)	m	35	50	50
without EMC category	m	100	100	100
Weight	kg	2.3	3.7	3.7
Weight	lb	5	8	8



Fusing data

Fusing data					
Inverter		i510-C0.37/400-3	i510-C0.55/400-3	i510-C0.75/400-3	i510-C1.1/400-3
Cable installation in compliance with		EN 60204-1			
without mains choke					
Circuit breaker					
Characteristics		B			
Max. Rated current	A	10	10	10	16
Fuse					
Characteristics		gG/gL or gRL			
Max. Rated current	A	10	10	10	16
with mains choke					
Circuit breaker					
Characteristics		B			
Max. Rated current	A	10	10	10	16
Fuse					
Characteristics		gG/gL or gRL			
Max. Rated current	A	10	10	10	16
Earth-leakage circuit breaker					
3-phase mains connection		≥ 30 mA, type B			

Fusing data					
Inverter		i510-C1.5/400-3		i510-C2.2/400-3	
Cable installation in compliance with		EN 60204-1			
without mains choke					
Circuit breaker					
Characteristics		B			
Max. Rated current	A	16		16	
Fuse					
Characteristics		gG/gL or gRL			
Max. Rated current	A	16		16	
with mains choke					
Circuit breaker					
Characteristics		B			
Max. Rated current	A	16		16	
Fuse					
Characteristics		gG/gL or gRL			
Max. Rated current	A	16		16	
Earth-leakage circuit breaker					
3-phase mains connection		≥ 30 mA, type B			

Technical data

3-phase mains connection 400 V

Fusing data



Fusing data					
Inverter		i510-C3.0/400-3	i510-C4.0/400-3	i510-C5.5/400-3	i510-C7.5/400-3
Cable installation in compliance with		EN 60204-1			
without mains choke					
Circuit breaker					
Characteristics		B			
Max. Rated current	A	25	25	25	32
Fuse					
Characteristics		gG/gL or gRL			
Max. Rated current	A	25	25	25	32
with mains choke					
Circuit breaker					
Characteristics		B			
Max. Rated current	A	25	25	25	32
Fuse					
Characteristics		gG/gL or gRL			
Max. Rated current	A	25	25	25	32
Earth-leakage circuit breaker					
3-phase mains connection		≥ 300 mA, type B			

Fusing data		
Inverter		i510-C11/400-3
Cable installation in compliance with		EN 60204-1
without mains choke		
Circuit breaker		
Characteristics		B
Max. Rated current	A	32
Fuse		
Characteristics		gG/gL or gRL
Max. Rated current	A	32
with mains choke		
Circuit breaker		
Characteristics		B
Max. Rated current	A	32
Fuse		
Characteristics		gG/gL or gRL
Max. Rated current	A	32
Earth-leakage circuit breaker		
3-phase mains connection		≥ 300 mA, type B



The values given below refer to the minimum SCCR values. The actual possible values for the UL fuse data (High SCCR) can be found in the appendix at: [UL fuses \(High SCCR\)](#) [153](#)

Fusing data					
Inverter		i510-C0.37/400-3	i510-C0.55/400-3	i510-C0.75/400-3	i510-C1.1/400-3
Cable installation in compliance with		US National Electrical Code NFPA 70 / Canadian Electrical Code C22.1			
without mains choke					
Fuse					
Characteristics		all acc. to UL 248 / Class CC			
Max. Rated current	A	15	15	15	15
Fusing type		Standard fusing			
SCCR: Requirement		Standard short-circuit strength			
SCCR: Max. Short-circuit current	kA	5	5	5	5
SCCR: Voltage		480/277 Volts Maximum			
with mains choke					
Fuse					
Characteristics		all acc. to UL 248 / Class CC			
Max. Rated current	A	15	15	15	15
Fusing type		Standard fusing			
SCCR: Requirement		Standard short-circuit strength			
SCCR: Max. Short-circuit current	kA	5	5	5	5
SCCR: Voltage		480/277 Volts Maximum			
Earth-leakage circuit breaker					
3-phase mains connection		≥ 30 mA, type B			

Fusing data					
Inverter		i510-C1.5/400-3		i510-C2.2/400-3	
Cable installation in compliance with		US National Electrical Code NFPA 70 / Canadian Electrical Code C22.1			
without mains choke					
Fuse					
Characteristics		all acc. to UL 248 / Class CC			
Max. Rated current	A	15		15	
Fusing type		Standard fusing			
SCCR: Requirement		Standard short-circuit strength			
SCCR: Max. Short-circuit current	kA	5		5	
SCCR: Voltage		480/277 Volts Maximum			
with mains choke					
Fuse					
Characteristics		all acc. to UL 248 / Class CC			
Max. Rated current	A	15		15	
Fusing type		Standard fusing			
SCCR: Requirement		Standard short-circuit strength			
SCCR: Max. Short-circuit current	kA	5		5	
SCCR: Voltage		480/277 Volts Maximum			
Earth-leakage circuit breaker					
3-phase mains connection		≥ 30 mA, type B			

Technical data

3-phase mains connection 400 V

Fusing data



Fusing data					
Inverter		i510-C3.0/400-3	i510-C4.0/400-3	i510-C5.5/400-3	i510-C7.5/400-3
Cable installation in compliance with		US National Electrical Code NFPA 70 / Canadian Electrical Code C22.1			
without mains choke					
Circuit breaker					
Characteristics		all acc. to UL 489			
Max. Rated current	A	25	25	25	35
Fusing type		Standard fusing			
SCCR: Requirement		Standard short-circuit strength			
SCCR: Max. Short-circuit current	kA	5	5	5	5
SCCR: Voltage		480/277 Volts Maximum			
Fuse					
Characteristics		all acc. to UL 248 / Class CC			all acc. to UL 248 / Class J, T, R
Max. Rated current	A	25	25	25	40
Fusing type		Standard fusing			
SCCR: Requirement		Standard short-circuit strength			
SCCR: Max. Short-circuit current	kA	5	5	5	5
SCCR: Voltage		480/277 Volts Maximum			
with mains choke					
Circuit breaker					
Characteristics		all acc. to UL 489			
Max. Rated current	A	25	25	25	35
Fusing type		Standard fusing			
SCCR: Requirement		Standard short-circuit strength			
SCCR: Max. Short-circuit current	kA	5	5	5	5
SCCR: Voltage		480/277 Volts Maximum			
Fuse					
Characteristics		all acc. to UL 248 / Class CC			all acc. to UL 248 / Class J, T, R
Max. Rated current	A	25	25	25	40
Fusing type		Standard fusing			
SCCR: Requirement		Standard short-circuit strength			
SCCR: Max. Short-circuit current	kA	5	5	5	5
SCCR: Voltage		480/277 Volts Maximum			
Earth-leakage circuit breaker					
3-phase mains connection		≥ 300 mA, type B			



Technical data

3-phase mains connection 400 V
Fusing data

Fusing data		
Inverter		i510-C11/400-3
Cable installation in compliance with		US National Electrical Code NFPA 70 / Canadian Electrical Code C22.1
without mains choke		
Circuit breaker		
Characteristics		-
Max. Rated current	A	-
Fusing type		-
SCCR: Requirement		-
SCCR: Max. Short-circuit current	kA	-
SCCR: Voltage		-
Fuse		
Characteristics		all acc. to UL 248 / Class J, T, R
Max. Rated current	A	40
Fusing type		Standard fusing
SCCR: Requirement		Standard short-circuit strength
SCCR: Max. Short-circuit current	kA	5
SCCR: Voltage		480/277 Volts Maximum
with mains choke		
Circuit breaker		
Characteristics		-
Max. Rated current	A	-
Fusing type		-
SCCR: Requirement		-
SCCR: Max. Short-circuit current	kA	-
SCCR: Voltage		-
Fuse		
Characteristics		all acc. to UL 248 / Class J, T, R
Max. Rated current	A	40
Fusing type		Standard fusing
SCCR: Requirement		Standard short-circuit strength
SCCR: Max. Short-circuit current	kA	5
SCCR: Voltage		480/277 Volts Maximum
Earth-leakage circuit breaker		
3-phase mains connection		≥ 300 mA, type B

Technical data

3-phase mains connection 400 V
Terminal data



Terminal data

Mains connection					
Inverter		i510-C0.37/400-3	i510-C0.55/400-3	i510-C0.75/400-3	i510-C1.1/400-3
Connection		X100			
Connection type		pluggable screw terminal			
Max. Cable cross-section	mm ²	2.5	2.5	2.5	2.5
Max. Cable cross-section	AWG	12	12	12	12
Stripping length	mm	8	8	8	8
Stripping length	inch	0.32	0.32	0.32	0.32
Tightening torque	Nm	0.5	0.5	0.5	0.5
Tightening torque	lb-in	4.4	4.4	4.4	4.4
Required tool		0.5 x 3.0			

Mains connection					
Inverter		i510-C1.5/400-3	i510-C2.2/400-3	i510-C3.0/400-3	i510-C4.0/400-3
Connection		X100			
Connection type		pluggable screw terminal		Screw terminal	
Max. Cable cross-section	mm ²	2.5	2.5	6	6
Max. Cable cross-section	AWG	12	12	10	10
Stripping length	mm	8	8	9	9
Stripping length	inch	0.32	0.32	0.35	0.35
Tightening torque	Nm	0.5	0.5	0.5	0.5
Tightening torque	lb-in	4.4	4.4	4.4	4.4
Required tool		0.5 x 3.0		0.6 x 3.5	

Mains connection					
Inverter		i510-C5.5/400-3	i510-C7.5/400-3	i510-C11/400-3	
Connection		X100			
Connection type		Screw terminal			
Max. Cable cross-section	mm ²	6	16	16	
Max. Cable cross-section	AWG	10	6	6	
Stripping length	mm	9	11	11	
Stripping length	inch	0.35	0.43	0.43	
Tightening torque	Nm	0.5	1.2	1.2	
Tightening torque	lb-in	4.4	11	11	
Required tool		0.6 x 3.5		0.8 x 4.0	

PE connection					
Inverter		i510-C0.37/400-3	i510-C0.55/400-3	i510-C0.75/400-3	i510-C1.1/400-3
Connection		PE			
Connection type		PE screw			
Max. Cable cross-section	mm ²	6	6	6	6
Max. Cable cross-section	AWG	10	10	10	10
Stripping length	mm	10	10	10	10
Stripping length	inch	0.39	0.39	0.39	0.39
Tightening torque	Nm	2	2	2	2
Tightening torque	lb-in	18	18	18	18
Required tool		Torx 20			



Technical data

3-phase mains connection 400 V
Terminal data

PE connection					
Inverter		i510-C1.5/400-3	i510-C2.2/400-3	i510-C3.0/400-3	i510-C4.0/400-3
Connection		PE			
Connection type		PE screw			
Max. Cable cross-section	mm ²	6	6	6	6
Max. Cable cross-section	AWG	10	10	10	10
Stripping length	mm	10	10	10	10
Stripping length	inch	0.39	0.39	0.39	0.39
Tightening torque	Nm	2	2	2	2
Tightening torque	lb-in	18	18	18	18
Required tool		Torx 20			

PE connection					
Inverter		i510-C5.5/400-3	i510-C7.5/400-3	i510-C11/400-3	
Connection		PE			
Connection type		PE screw			
Max. Cable cross-section	mm ²	6	16	16	
Max. Cable cross-section	AWG	10	6	6	
Stripping length	mm	10	11	11	
Stripping length	inch	0.39	0.43	0.43	
Tightening torque	Nm	2	3.4	3.4	
Tightening torque	lb-in	18	30	30	
Required tool		Torx 20	PZ2		

Motor connection					
Inverter		i510-C0.37/400-3	i510-C0.55/400-3	i510-C0.75/400-3	i510-C1.1/400-3
Connection		X105			
Connection type		pluggable screw terminal			
Max. Cable cross-section	mm ²	2.5	2.5	2.5	2.5
Max. Cable cross-section	AWG	12	12	12	12
Stripping length	mm	8	8	8	8
Stripping length	inch	0.32	0.32	0.32	0.32
Tightening torque	Nm	0.5	0.5	0.5	0.5
Tightening torque	lb-in	4.4	4.4	4.4	4.4
Required tool		0.5 x 3.0			

Motor connection					
Inverter		i510-C1.5/400-3	i510-C2.2/400-3	i510-C3.0/400-3	i510-C4.0/400-3
Connection		X105			
Connection type		pluggable screw terminal		Screw terminal	
Max. Cable cross-section	mm ²	2.5	2.5	6	6
Max. Cable cross-section	AWG	12	12	10	10
Stripping length	mm	8	8	9	9
Stripping length	inch	0.32	0.32	0.35	0.35
Tightening torque	Nm	0.5	0.5	0.5	0.5
Tightening torque	lb-in	4.4	4.4	4.4	4.4
Required tool		0.5 x 3.0		0.6 x 3.5	

Technical data

3-phase mains connection 400 V
Mains chokes



Motor connection				
Inverter		i510-C5.5/400-3	i510-C7.5/400-3	i510-C11/400-3
Connection		X105		
Connection type		Screw terminal		
Max. Cable cross-section	mm ²	6	16	16
Max. Cable cross-section	AWG	10	6	6
Stripping length	mm	9	11	11
Stripping length	inch	0.35	0.43	0.43
Tightening torque	Nm	0.5	1.2	1.2
Tightening torque	lb-in	4.4	11	11
Required tool		0.6 x 3.5		0.8 x 4.0

Mains chokes

Inverter	Order code	Number of phases	Mains choke			
			Rated current	Inductance	Dimensions (h x w x d)	Weight
			A	mH	mm	kg
i510-C0.37/400-3	EZAELN3002B203	3	1.5	19.6	56 x 77 x 100	0.52
i510-C0.55/400-3	EZAELN3002B153		2	14.7		0.53
i510-C0.75/400-3	EZAELN3004B742		4	7.35	60 x 95 x 115	1.31
i510-C1.1/400-3						
i510-C1.5/400-3						
i510-C2.2/400-3	EZAELN3006B492		6	4.9	69 x 95 x 120	1.45
i510-C3.0/400-3	EZAELN3008B372		8	3.68	85 x 120 x 140	1.9
i510-C4.0/400-3	EZAELN3010B292		10	2.94		2
i510-C5.5/400-3	EZAELN3016B182		16	1.84	95 x 120 x 140	2.7
i510-C7.5/400-3						
i510-C11/400-3	EZAELN3025B122		25	1.18	110 x 155 x 170	5.8



RFI filters / Mains filters

Basic information on RFI filters, mains filters and EMC: from [147](#)



EMC filters can be used both in the side structure and in the substructure.

Maximum motor cable lengths and FI operation

Mains connection			3-phase, 400 V/480 V			
Inverter			i510-C0.37/400-3	i510-C0.55/400-3 i510-C0.75/400-3	i510-C1.1/400-3 i510-C1.5/400-3 i510-C2.2/400-3	i510-C3.0/400-3 i510-C4.0/400-3 i510-C5.5/400-3 i510-C7.5/400-3 i510-C11/400-3
With integrated RFI filter						
Without EMC category Thermal limitation	Shielded motor cable length	m	15	50	50	100
	Unshielded motor cable length	m	30	100	200	200
With integrated RFI filter						
Category C1	Shielded motor cable length	m	-	-	-	-
Category C2		m	15	15	20	20
	Earth-leakage circuit breaker	mA	30	30	30	300
RFI filter Low Leakage						
Category C1	Shielded motor cable length	m	-	-	-	-
	Earth-leakage circuit breaker	mA	-	-	-	-
RFI filter Short Distance						
Category C1	Shielded motor cable length	m	15	25	25	25
Category C2		m	15	50	50	50
	Earth-leakage circuit breaker	mA	30	30	30	30
RFI filter Long Distance						
Category C1	Shielded motor cable length	m	15	50	50	50
Category C2		m	15	50	50	100
	Earth-leakage circuit breaker	mA	300	300	300	300

Short Distance

Inverter	RFI filter		
	Order code	Dimensions (h x w x d)	Weight
		mm	kg
i510-C0.37/400-3	IOFAE175F100S0000S	276 x 60 x 50	0.9
i510-C0.55/400-3			
i510-C0.75/400-3			
i510-C1.1/400-3	IOFAE222F100S0000S	346 x 60 x 50	1.1
i510-C1.5/400-3			
i510-C2.2/400-3			
i510-C3.0/400-3	IOFAE255F100S0001S	346 x 90 x 60	2.1
i510-C4.0/400-3			
i510-C5.5/400-3			
i510-C7.5/400-3	IOFAE311F100S0000S	371 x 120 x 60	2.4
i510-C11/400-3			

Technical data

3-phase mains connection 400 V
Sine filter



Long Distance

Inverter	RFI filter		
	Order code	Dimensions (h x w x d)	Weight
		mm	kg
i510-C0.37/400-3	IOFAE175F100D0000S	276 x 60 x 50	0.9
i510-C0.55/400-3			
i510-C0.75/400-3			
i510-C1.1/400-3	IOFAE222F100D0000S	346 x 60 x 50	1.1
i510-C1.5/400-3			
i510-C2.2/400-3			
i510-C3.0/400-3	IOFAE255F100D0001S	346 x 90 x 60	1.7
i510-C4.0/400-3			
i510-C5.5/400-3			
i510-C7.5/400-3	IOFAE311F100D0000S	371 x 120 x 60	2.1
i510-C11/400-3			

Sine filter

Inverter	Sine filters			
	Switching frequency	Order code	Rated inductance	Max. output frequency
	kHz		mH	Hz
i510-C0.37/400-3	4 8	EZS3-004A200	11.0	150
i510-C0.55/400-3				
i510-C0.75/400-3				
i510-C1.1/400-3		EZS3-010A200	5.10	
i510-C1.5/400-3				
i510-C2.2/400-3		EZS3-017A200	3.07	
i510-C3.0/400-3				
i510-C4.0/400-3				
i510-C5.5/400-3				
i510-C7.5/400-3		EZS3-024A200	2.50	
i510-C11/400-3				



3-phase mains connection 400 V "Light Duty"

Rated data

The output currents apply to these operating conditions:

- At a switching frequency of 2 kHz or 4 kHz: Ambient temperature above 40 °C with a rated output current reduced by 2.5 %/°C.
- If the load characteristic "Light Duty" and the switching frequencies 8 kHz or 16 kHz are selected, only the values of the load characteristic "Heavy Duty" are reached.

Inverter		i510-C3.0/400-3	i510-C4.0/400-3	i510-C5.5/400-3	i510-C7.5/400-3
Rated power	kW	4	5.5	7.5	11
Rated power	hp	5	7.5	10	15
Mains voltage range		3/PE AC 340 V ... 528 V, 45 Hz ... 65 Hz			
Output voltage		3 AC 0-400/480 V			
Rated mains current					
without mains choke	A	10.3	14	18.3	28
with mains choke	A	8.2	11	14.5	22
Apparent output power	kVA	5.9	8	10.5	15
Rated output current					
2 kHz	A	8.8	11.9	15.6	23
4 kHz	A	8.8	11.9	15.6	23
8 kHz	A	-	-	-	-
16 kHz	A	-	-	-	-
Power loss					
2 kHz	W	94	125	163	238
4 kHz	W	100	133	173	253
8 kHz	W	-	-	-	-
16 kHz	W	-	-	-	-
at inverter disablecontroller inhibit	W	6	6	6	6
Overcurrent cycle 180 s					
Max. Output current	A	11	14.3	19.5	23.6
Overload time	s	60	60	60	60
Recovery time	s	120	120	120	120
Max. output current during the recovery time	A	5.5	7.1	9.8	12.4
Overcurrent cycle 15 s					
Max. Output current	A	14.6	19	26	33
Overload time	s	3	3	3	3
Recovery time	s	12	12	12	12
Max. output current during the recovery time	A	5.5	7.1	9.8	12.4
Cyclic mains switching		3 times per minute			
Brake chopper					
Max. Output current	A	-	-	-	-
Min. Brake resistor	Ω	-	-	-	-
Max. Shielded motor cable length					
Category C2 (2 kHz, 4 kHz, 8 kHz)	m	20	20	20	20
Category C3 (2 kHz, 4 kHz, 8 kHz)	m	35	35	35	50
without EMC category	m	100	100	100	100
Weight	kg	2.3	2.3	2.3	3.7
Weight	lb	5	5	5	8

Technical data

3-phase mains connection 400 V "Light Duty"
 Rated data



Inverter		i510-C11/400-3
Rated power	kW	15
Rated power	hp	20
Mains voltage range		3/PE AC 340 V ... 528 V, 45 Hz ... 65 Hz
Output voltage		3 AC 0-400/480 V
Rated mains current		
without mains choke	A	-
with mains choke	A	27.1
Apparent output power	kVA	19
Rated output current		
2 kHz	A	28.2
4 kHz	A	28.2
8 kHz	A	-
16 kHz	A	-
Power loss		
2 kHz	W	290
4 kHz	W	309
8 kHz	W	-
16 kHz	W	-
at inverter disablecontroller inhibit	W	6
Overcurrent cycle 180 s		
Max. Output current	A	35
Overload time	s	60
Recovery time	s	120
Max. output current during the recovery time	A	17.6
Overcurrent cycle 15 s		
Max. Output current	A	47
Overload time	s	3
Recovery time	s	12
Max. output current during the recovery time	A	17.6
Cyclic mains switching		3 times per minute
Brake chopper		
Max. Output current	A	-
Min. Brake resistor	Ω	-
Max. Shielded motor cable length		
Category C2 (2 kHz, 4 kHz, 8 kHz)	m	20
Category C3 (2 kHz, 4 kHz, 8 kHz)	m	50
without EMC category	m	100
Weight	kg	3.7
Weight	lb	8



Technical data

3-phase mains connection 400 V "Light Duty"
Fusing data

Fusing data

Fusing data					
Inverter		i510-C3.0/400-3	i510-C4.0/400-3	i510-C5.5/400-3	i510-C7.5/400-3
Cable installation in compliance with		EN 60204-1			
without mains choke					
Circuit breaker					
Characteristics		B			
Max. Rated current	A	25	25	25	32
Fuse					
Characteristics		gG/gL or gRL			
Max. Rated current	A	25	25	25	32
with mains choke					
Circuit breaker					
Characteristics		B			
Max. Rated current	A	25	25	25	32
Fuse					
Characteristics		gG/gL or gRL			
Max. Rated current	A	25	25	25	32
Earth-leakage circuit breaker					
3-phase mains connection		≥ 300 mA, type B			

Fusing data					
Inverter		i510-C11/400-3			
Cable installation in compliance with		EN 60204-1			
without mains choke					
Circuit breaker					
Characteristics		-			
Max. Rated current	A	-			
Fuse					
Characteristics		-			
Max. Rated current	A	-			
with mains choke					
Circuit breaker					
Characteristics		B			
Max. Rated current	A	32			
Fuse					
Characteristics		gG/gL or gRL			
Max. Rated current	A	32			
Earth-leakage circuit breaker					
3-phase mains connection		≥ 300 mA, type B			

Technical data

3-phase mains connection 400 V "Light Duty"

Fusing data



The values given below refer to the minimum SCCR values. The actual possible values for the UL fuse data (High SCCR) can be found in the appendix at: [▶ UL fuses \(High SCCR\)](#) [□ 153](#)

Fusing data					
Inverter		i510-C3.0/400-3	i510-C4.0/400-3	i510-C5.5/400-3	i510-C7.5/400-3
Cable installation in compliance with		US National Electrical Code NFPA 70 / Canadian Electrical Code C22.1			
without mains choke					
Circuit breaker					
Characteristics		all acc. to UL 489			
Max. Rated current	A	25	25	25	35
Fusing type		Standard fusing			
SCCR: Requirement		Standard short-circuit strength			
SCCR: Max. Short-circuit current	kA	5	5	5	5
SCCR: Voltage		480/277 Volts Maximum			
Fuse					
Characteristics		all acc. to UL 248 / Class CC			all acc. to UL 248 / Class J, T, R
Max. Rated current	A	25	25	25	40
Fusing type		Standard fusing			
SCCR: Requirement		Standard short-circuit strength			
SCCR: Max. Short-circuit current	kA	5	5	5	5
SCCR: Voltage		480/277 Volts Maximum			
with mains choke					
Circuit breaker					
Characteristics		all acc. to UL 489			
Max. Rated current	A	25	25	25	35
Fusing type		Standard fusing			
SCCR: Requirement		Standard short-circuit strength			
SCCR: Max. Short-circuit current	kA	5	5	5	5
SCCR: Voltage		480/277 Volts Maximum			
Fuse					
Characteristics		all acc. to UL 248 / Class CC			all acc. to UL 248 / Class J, T, R
Max. Rated current	A	25	25	25	40
Fusing type		Standard fusing			
SCCR: Requirement		Standard short-circuit strength			
SCCR: Max. Short-circuit current	kA	5	5	5	5
SCCR: Voltage		480/277 Volts Maximum			
Earth-leakage circuit breaker					
3-phase mains connection		≥ 300 mA, type B			



Technical data

3-phase mains connection 400 V "Light Duty"
Fusing data

Fusing data		
Inverter		i510-C11/400-3
Cable installation in compliance with		US National Electrical Code NFPA 70 / Canadian Electrical Code C22.1
without mains choke		
Circuit breaker		
Characteristics		-
Max. Rated current	A	-
Fusing type		-
SCCR: Requirement		-
SCCR: Max. Short-circuit current	kA	-
SCCR: Voltage		-
Fuse		
Characteristics		-
Max. Rated current	A	-
Fusing type		-
SCCR: Requirement		-
SCCR: Max. Short-circuit current	kA	-
SCCR: Voltage		-
with mains choke		
Circuit breaker		
Characteristics		-
Max. Rated current	A	-
Fusing type		-
SCCR: Requirement		-
SCCR: Max. Short-circuit current	kA	-
SCCR: Voltage		-
Fuse		
Characteristics		all acc. to UL 248 / Class J, T, R
Max. Rated current	A	40
Fusing type		Standard fusing
SCCR: Requirement		Standard short-circuit strength
SCCR: Max. Short-circuit current	kA	5
SCCR: Voltage		480/277 Volts Maximum
Earth-leakage circuit breaker		
3-phase mains connection		≥ 300 mA, type B

Technical data

3-phase mains connection 400 V "Light Duty"
Terminal data



Terminal data

Mains connection					
Inverter		i510-C3.0/400-3	i510-C4.0/400-3	i510-C5.5/400-3	i510-C7.5/400-3
Connection		X100			
Connection type		Screw terminal			
Max. Cable cross-section	mm ²	6	6	6	16
Max. Cable cross-section	AWG	10	10	10	6
Stripping length	mm	9	9	9	11
Stripping length	inch	0.35	0.35	0.35	0.43
Tightening torque	Nm	0.5	0.5	0.5	1.2
Tightening torque	lb-in	4.4	4.4	4.4	11
Required tool		0.6 x 3.5			0.8 x 4.0

Mains connection	
Inverter	i510-C11/400-3
Connection	X100
Connection type	Screw terminal
Max. Cable cross-section	mm ² 16
Max. Cable cross-section	AWG 6
Stripping length	mm 11
Stripping length	inch 0.43
Tightening torque	Nm 1.2
Tightening torque	lb-in 11
Required tool	0.8 x 4.0

PE connection					
Inverter		i510-C3.0/400-3	i510-C4.0/400-3	i510-C5.5/400-3	i510-C7.5/400-3
Connection		PE			
Connection type		PE screw			
Max. Cable cross-section	mm ²	6	6	6	16
Max. Cable cross-section	AWG	10	10	10	6
Stripping length	mm	10	10	10	11
Stripping length	inch	0.39	0.39	0.39	0.43
Tightening torque	Nm	2	2	2	3.4
Tightening torque	lb-in	18	18	18	30
Required tool		Torx 20			P22

PE connection	
Inverter	i510-C11/400-3
Connection	PE
Connection type	PE screw
Max. Cable cross-section	mm ² 16
Max. Cable cross-section	AWG 6
Stripping length	mm 11
Stripping length	inch 0.43
Tightening torque	Nm 3.4
Tightening torque	lb-in 30
Required tool	P22



Technical data

3-phase mains connection 400 V "Light Duty"
Mains chokes

Motor connection					
Inverter		i510-C3.0/400-3	i510-C4.0/400-3	i510-C5.5/400-3	i510-C7.5/400-3
Connection		X105			
Connection type		Screw terminal			
Max. Cable cross-section	mm ²	6	6	6	16
Max. Cable cross-section	AWG	10	10	10	6
Stripping length	mm	9	9	9	11
Stripping length	inch	0.35	0.35	0.35	0.43
Tightening torque	Nm	0.5	0.5	0.5	1.2
Tightening torque	lb-in	4.4	4.4	4.4	11
Required tool		0.6 x 3.5			0.8 x 4.0

Motor connection					
Inverter		i510-C11/400-3			
Connection		X105			
Connection type		Screw terminal			
Max. Cable cross-section	mm ²	16			
Max. Cable cross-section	AWG	6			
Stripping length	mm	11			
Stripping length	inch	0.43			
Tightening torque	Nm	1.2			
Tightening torque	lb-in	11			
Required tool		0.8 x 4.0			

Mains chokes

Inverter	Order code	Number of phases	Mains choke			
			Rated current	Inductance	Dimensions (h x w x d)	Weight
			A	mH	mm	kg
i510-C3.0/400-3	EZAELN3010B292	3	10	2.94	85 x 120 x 140	2
i510-C4.0/400-3	EZAELN3016B182		16	1.84	95 x 120 x 140	2.7
i510-C5.5/400-3			25	1.18	110 x 155 x 170	5.8
i510-C7.5/400-3	EZAELN3025B122		30	0.98		5.85
i510-C11/400-3	EZAELN3030B981					

Technical data

3-phase mains connection 400 V "Light Duty"
RFI filters / Mains filters



RFI filters / Mains filters

Basic information on RFI filters, mains filters and EMC: from [147](#)



EMC filters can be used both in the side structure and in the substructure.

Maximum motor cable lengths and FI operation

Mains connection		3-phase, 400 V/480 V	
Inverter		i510-C3.0/400-3 i510-C4.0/400-3 i510-C5.5/400-3 i510-C7.5/400-3 i510-C11/400-3	
With integrated RFI filter			
Without EMC category Thermal limitation	Shielded motor cable length	m	100
	Unshielded motor cable length	m	200
With integrated RFI filter			
Category C1	Shielded motor cable length	m	-
Category C2		m	20
	Earth-leakage circuit breaker	mA	300
RFI filter Low Leakage			
Category C1	Shielded motor cable length	m	-
	Earth-leakage circuit breaker	mA	-
RFI filter Short Distance			
Category C1	Shielded motor cable length	m	25
Category C2		m	50
	Earth-leakage circuit breaker	mA	30
RFI filter Long Distance			
Category C1	Shielded motor cable length	m	50
Category C2		m	100
	Earth-leakage circuit breaker	mA	300

Short Distance

Inverter	RFI filter		
	Order code	Dimensions (h x w x d)	Weight
		mm	kg
i510-C3.0/400-3	IOFAE255F100S0001S	346 x 90 x 60	2.1
i510-C4.0/400-3			
i510-C5.5/400-3			
i510-C7.5/400-3	IOFAE311F100S0000S	371 x 120 x 60	2.4
i510-C11/400-3			

Long Distance

Inverter	RFI filter		
	Order code	Dimensions (h x w x d)	Weight
		mm	kg
i510-C3.0/400-3	IOFAE255F100D0001S	346 x 90 x 60	1.7
i510-C4.0/400-3			
i510-C5.5/400-3			
i510-C7.5/400-3	IOFAE311F100D0000S	371 x 120 x 60	2.1
i510-C11/400-3			



3-phase mains connection 480 V

Rated data

The output currents apply to these operating conditions:

- At a switching frequency of 2 kHz or 4 kHz: Max. ambient temperature 45°C.
- At a switching frequency of 8 kHz or 16 kHz: Max. ambient temperature 40 °C.

Inverter		i510-C0.37/400-3	i510-C0.55/400-3	i510-C0.75/400-3	i510-C1.1/400-3
Rated power	kW	0.37	0.55	0.75	1.1
Rated power	hp	0.5	0.75	1	1.5
Mains voltage range		3/PE AC 340 V ... 528 V, 45 Hz ... 65 Hz			
Output voltage		3 AC 0-400/480 V			
Rated mains current					
without mains choke	A	1.5	2.1	2.8	3.7
with mains choke	A	1.2	1.7	2.2	2.5
Apparent output power	kVA	0.9	1.2	1.6	2.2
Rated output current					
2 kHz	A	-	1.6	2.1	3
4 kHz	A	1.1	1.6	2.1	3
8 kHz	A	1.1	1.6	2.1	3
16 kHz	A	0.7	1.1	1.4	2
Power loss					
2 kHz	W	-	24	30	38
4 kHz	W	20	25	32	40
8 kHz	W	24	31	40	51
16 kHz	W	24	31	40	51
at inverter disablecontroller inhibit	W	6	6	6	6
Overcurrent cycle 180 s					
Max. Output current	A	1.7	2.4	3.2	4.5
Overload time	s	60	60	60	60
Recovery time	s	120	120	120	120
Max. output current during the recovery time	A	0.8	1.2	1.6	2.3
Overcurrent cycle 15 s					
Max. Output current	A	2.2	3.2	4.2	6
Overload time	s	3	3	3	3
Recovery time	s	12	12	12	12
Max. output current during the recovery time	A	0.8	1.2	1.6	2.3
Cyclic mains switching		3 times per minute			
Brake chopper					
Max. Output current	A	-	-	-	-
Min. Brake resistor	Ω	-	-	-	-
Max. Shielded motor cable length					
Category C2 (2 kHz, 4 kHz, 8 kHz)	m	15	15	15	20
Category C3 (2 kHz, 4 kHz, 8 kHz)	m	15	20	20	35
without EMC category	m	15	50	50	50
Weight	kg	0.75	0.95	0.95	1.35
Weight	lb	1.7	2.1	2.1	3

Technical data

3-phase mains connection 480 V

Rated data



Inverter		i510-C1.5/400-3	i510-C2.2/400-3	i510-C3.0/400-3	i510-C4.0/400-3
Rated power	kW	1.5	2.2	3	4
Rated power	hp	2	3	4	5
Mains voltage range		3/PE AC 340 V ... 528 V, 45 Hz ... 65 Hz			
Output voltage		3 AC 0-400/480 V			
Rated mains current					
without mains choke	A	4.5	6.5	8	10.5
with mains choke	A	3.1	4.4	5.8	7.5
Apparent output power	kVA	2.6	3.8	4.9	6.4
Rated output current					
2 kHz	A	3.5	4.8	6.3	8.2
4 kHz	A	3.5	4.8	6.3	8.2
8 kHz	A	3.5	4.8	6.3	8.2
16 kHz	A	2.3	3.2	4.2	5.5
Power loss					
2 kHz	W	45	62	79	102
4 kHz	W	48	66	85	110
8 kHz	W	61	85	110	140
16 kHz	W	61	85	109	140
at inverter disablecontroller inhibit	W	6	6	6	6
Overcurrent cycle 180 s					
Max. Output current	A	5.3	7.2	9.5	12.3
Overload time	s	60	60	60	60
Recovery time	s	120	120	120	120
Max. output current during the recovery time	A	2.6	3.6	4.8	6.2
Overcurrent cycle 15 s					
Max. Output current	A	7	9.6	12.6	16.4
Overload time	s	3	3	3	3
Recovery time	s	12	12	12	12
Max. output current during the recovery time	A	2.6	3.6	4.7	6.2
Cyclic mains switching		3 times per minute			
Brake chopper					
Max. Output current	A	-	-	-	-
Min. Brake resistor	Ω	-	-	-	-
Max. Shielded motor cable length					
Category C2 (2 kHz, 4 kHz, 8 kHz)	m	20	20	20	20
Category C3 (2 kHz, 4 kHz, 8 kHz)	m	35	35	35	35
without EMC category	m	50	50	100	100
Weight	kg	1.35	1.35	2.3	2.3
Weight	lb	3	3	5	5



Technical data

3-phase mains connection 480 V
Rated data

Inverter		i510-C5.5/400-3	i510-C7.5/400-3	i510-C11/400-3
Rated power	kW	5.5	7.5	11
Rated power	hp	7.5	10	15
Mains voltage range		3/PE AC 340 V ... 528 V, 45 Hz ... 65 Hz		
Output voltage		3 AC 0-400/480 V		
Rated mains current				
without mains choke	A	14.3	16.6	23.7
with mains choke	A	10.3	13.1	18.6
Apparent output power	kVA	8.7	11	16
Rated output current				
2 kHz	A	11	14	21
4 kHz	A	11	14	21
8 kHz	A	11	14	21
16 kHz	A	7.3	9.3	14
Power loss				
2 kHz	W	137	172	242
4 kHz	W	145	185	260
8 kHz	W	190	240	340
16 kHz	W	189	238	337
at inverter disablecontroller inhibit	W	6	6	6
Overcurrent cycle 180 s				
Max. Output current	A	16.5	21	31.5
Overload time	s	60	60	60
Recovery time	s	120	120	120
Max. output current during the recovery time	A	8.3	10.5	15.8
Overcurrent cycle 15 s				
Max. Output current	A	22	28	42
Overload time	s	3	3	3
Recovery time	s	12	12	12
Max. output current during the recovery time	A	8.3	10.5	15.8
Cyclic mains switching		3 times per minute		
Brake chopper				
Max. Output current	A	-	-	-
Min. Brake resistor	Ω	-	-	-
Max. Shielded motor cable length				
Category C2 (2 kHz, 4 kHz, 8 kHz)	m	20	20	20
Category C3 (2 kHz, 4 kHz, 8 kHz)	m	35	50	50
without EMC category	m	100	100	100
Weight	kg	2.3	3.7	3.7
Weight	lb	5	8	8

Technical data

3-phase mains connection 480 V

Fusing data



Fusing data

Fusing data					
Inverter		i510-C0.37/400-3	i510-C0.55/400-3	i510-C0.75/400-3	i510-C1.1/400-3
Cable installation in compliance with		EN 60204-1			
without mains choke					
Circuit breaker					
Characteristics		B			
Max. Rated current	A	10	10	10	16
Fuse					
Characteristics		gG/gL or gRL			
Max. Rated current	A	10	10	10	16
with mains choke					
Circuit breaker					
Characteristics		B			
Max. Rated current	A	10	10	10	16
Fuse					
Characteristics		gG/gL or gRL			
Max. Rated current	A	10	10	10	16
Earth-leakage circuit breaker					
3-phase mains connection		≥ 30 mA, type B			

Fusing data					
Inverter		i510-C1.5/400-3		i510-C2.2/400-3	
Cable installation in compliance with		EN 60204-1			
without mains choke					
Circuit breaker					
Characteristics		B			
Max. Rated current	A	16		16	
Fuse					
Characteristics		gG/gL or gRL			
Max. Rated current	A	16		16	
with mains choke					
Circuit breaker					
Characteristics		B			
Max. Rated current	A	16		16	
Fuse					
Characteristics		gG/gL or gRL			
Max. Rated current	A	16		16	
Earth-leakage circuit breaker					
3-phase mains connection		≥ 30 mA, type B			



Technical data

3-phase mains connection 480 V
Fusing data

Fusing data					
Inverter		i510-C3.0/400-3	i510-C4.0/400-3	i510-C5.5/400-3	i510-C7.5/400-3
Cable installation in compliance with		EN 60204-1			
without mains choke					
Circuit breaker					
Characteristics		B			
Max. Rated current	A	25	25	25	32
Fuse					
Characteristics		gG/gL or gRL			
Max. Rated current	A	25	25	25	32
with mains choke					
Circuit breaker					
Characteristics		B			
Max. Rated current	A	25	25	25	32
Fuse					
Characteristics		gG/gL or gRL			
Max. Rated current	A	25	25	25	32
Earth-leakage circuit breaker					
3-phase mains connection		≥ 300 mA, type B			

Fusing data		
Inverter		i510-C11/400-3
Cable installation in compliance with		EN 60204-1
without mains choke		
Circuit breaker		
Characteristics		B
Max. Rated current	A	32
Fuse		
Characteristics		gG/gL or gRL
Max. Rated current	A	32
with mains choke		
Circuit breaker		
Characteristics		B
Max. Rated current	A	32
Fuse		
Characteristics		gG/gL or gRL
Max. Rated current	A	32
Earth-leakage circuit breaker		
3-phase mains connection		≥ 300 mA, type B

Technical data

3-phase mains connection 480 V

Fusing data



The values given below refer to the minimum SCCR values. The actual possible values for the UL fuse data (High SCCR) can be found in the appendix at: [UL fuses \(High SCCR\)](#) [153](#)

Fusing data					
Inverter		i510-C0.37/400-3	i510-C0.55/400-3	i510-C0.75/400-3	i510-C1.1/400-3
Cable installation in compliance with		US National Electrical Code NFPA 70 / Canadian Electrical Code C22.1			
without mains choke					
Fuse					
Characteristics		all acc. to UL 248 / Class CC			
Max. Rated current	A	15	15	15	15
Fusing type		Standard fusing			
SCCR: Requirement		Standard short-circuit strength			
SCCR: Max. Short-circuit current	kA	5	5	5	5
SCCR: Voltage		480/277 Volts Maximum			
with mains choke					
Fuse					
Characteristics		all acc. to UL 248 / Class CC			
Max. Rated current	A	15	15	15	15
Fusing type		Standard fusing			
SCCR: Requirement		Standard short-circuit strength			
SCCR: Max. Short-circuit current	kA	5	5	5	5
SCCR: Voltage		480/277 Volts Maximum			
Earth-leakage circuit breaker					
3-phase mains connection		≥ 30 mA, type B			

Fusing data			
Inverter		i510-C1.5/400-3	i510-C2.2/400-3
Cable installation in compliance with		US National Electrical Code NFPA 70 / Canadian Electrical Code C22.1	
without mains choke			
Fuse			
Characteristics		all acc. to UL 248 / Class CC	
Max. Rated current	A	15	15
Fusing type		Standard fusing	
SCCR: Requirement		Standard short-circuit strength	
SCCR: Max. Short-circuit current	kA	5	5
SCCR: Voltage		480/277 Volts Maximum	
with mains choke			
Fuse			
Characteristics		all acc. to UL 248 / Class CC	
Max. Rated current	A	15	15
Fusing type		Standard fusing	
SCCR: Requirement		Standard short-circuit strength	
SCCR: Max. Short-circuit current	kA	5	5
SCCR: Voltage		480/277 Volts Maximum	
Earth-leakage circuit breaker			
3-phase mains connection		≥ 30 mA, type B	



Technical data

3-phase mains connection 480 V
Fusing data

Fusing data					
Inverter		i510-C3.0/400-3	i510-C4.0/400-3	i510-C5.5/400-3	i510-C7.5/400-3
Cable installation in compliance with		US National Electrical Code NFPA 70 / Canadian Electrical Code C22.1			
without mains choke					
Circuit breaker					
Characteristics		all acc. to UL 489			
Max. Rated current	A	25	25	25	35
Fusing type		Standard fusing			
SCCR: Requirement		Standard short-circuit strength			
SCCR: Max. Short-circuit current	kA	5	5	5	5
SCCR: Voltage		480/277 Volts Maximum			
Fuse					
Characteristics		all acc. to UL 248 / Class CC			all acc. to UL 248 / Class J, T, R
Max. Rated current	A	25	25	25	40
Fusing type		Standard fusing			
SCCR: Requirement		Standard short-circuit strength			
SCCR: Max. Short-circuit current	kA	5	5	5	5
SCCR: Voltage		480/277 Volts Maximum			
with mains choke					
Circuit breaker					
Characteristics		all acc. to UL 489			
Max. Rated current	A	25	25	25	35
Fusing type		Standard fusing			
SCCR: Requirement		Standard short-circuit strength			
SCCR: Max. Short-circuit current	kA	5	5	5	5
SCCR: Voltage		480/277 Volts Maximum			
Fuse					
Characteristics		all acc. to UL 248 / Class CC			all acc. to UL 248 / Class J, T, R
Max. Rated current	A	25	25	25	40
Fusing type		Standard fusing			
SCCR: Requirement		Standard short-circuit strength			
SCCR: Max. Short-circuit current	kA	5	5	5	5
SCCR: Voltage		480/277 Volts Maximum			
Earth-leakage circuit breaker					
3-phase mains connection		≥ 300 mA, type B			

Technical data

3-phase mains connection 480 V

Fusing data



Fusing data		
Inverter		i510-C11/400-3
Cable installation in compliance with		US National Electrical Code NFPA 70 / Canadian Electrical Code C22.1
without mains choke		
Circuit breaker		
Characteristics		-
Max. Rated current	A	-
Fusing type		-
SCCR: Requirement		-
SCCR: Max. Short-circuit current	kA	-
SCCR: Voltage		-
Fuse		
Characteristics		all acc. to UL 248 / Class J, T, R
Max. Rated current	A	40
Fusing type		Standard fusing
SCCR: Requirement		Standard short-circuit strength
SCCR: Max. Short-circuit current	kA	5
SCCR: Voltage		480/277 Volts Maximum
with mains choke		
Circuit breaker		
Characteristics		-
Max. Rated current	A	-
Fusing type		-
SCCR: Requirement		-
SCCR: Max. Short-circuit current	kA	-
SCCR: Voltage		-
Fuse		
Characteristics		all acc. to UL 248 / Class J, T, R
Max. Rated current	A	40
Fusing type		Standard fusing
SCCR: Requirement		Standard short-circuit strength
SCCR: Max. Short-circuit current	kA	5
SCCR: Voltage		480/277 Volts Maximum
Earth-leakage circuit breaker		
3-phase mains connection		≥ 300 mA, type B



Terminal data

Mains connection					
Inverter		i510-C0.37/400-3	i510-C0.55/400-3	i510-C0.75/400-3	i510-C1.1/400-3
Connection		X100			
Connection type		pluggable screw terminal			
Max. Cable cross-section	mm ²	2.5	2.5	2.5	2.5
Max. Cable cross-section	AWG	12	12	12	12
Stripping length	mm	8	8	8	8
Stripping length	inch	0.32	0.32	0.32	0.32
Tightening torque	Nm	0.5	0.5	0.5	0.5
Tightening torque	lb-in	4.4	4.4	4.4	4.4
Required tool		0.5 x 3.0			

Mains connection					
Inverter		i510-C1.5/400-3	i510-C2.2/400-3	i510-C3.0/400-3	i510-C4.0/400-3
Connection		X100			
Connection type		pluggable screw terminal		Screw terminal	
Max. Cable cross-section	mm ²	2.5	2.5	6	6
Max. Cable cross-section	AWG	12	12	10	10
Stripping length	mm	8	8	9	9
Stripping length	inch	0.32	0.32	0.35	0.35
Tightening torque	Nm	0.5	0.5	0.5	0.5
Tightening torque	lb-in	4.4	4.4	4.4	4.4
Required tool		0.5 x 3.0		0.6 x 3.5	

Mains connection					
Inverter		i510-C5.5/400-3	i510-C7.5/400-3	i510-C11/400-3	
Connection		X100			
Connection type		Screw terminal			
Max. Cable cross-section	mm ²	6	16	16	
Max. Cable cross-section	AWG	10	6	6	
Stripping length	mm	9	11	11	
Stripping length	inch	0.35	0.43	0.43	
Tightening torque	Nm	0.5	1.2	1.2	
Tightening torque	lb-in	4.4	11	11	
Required tool		0.6 x 3.5		0.8 x 4.0	

PE connection					
Inverter		i510-C0.37/400-3	i510-C0.55/400-3	i510-C0.75/400-3	i510-C1.1/400-3
Connection		PE			
Connection type		PE screw			
Max. Cable cross-section	mm ²	6	6	6	6
Max. Cable cross-section	AWG	10	10	10	10
Stripping length	mm	10	10	10	10
Stripping length	inch	0.39	0.39	0.39	0.39
Tightening torque	Nm	2	2	2	2
Tightening torque	lb-in	18	18	18	18
Required tool		Torx 20			

Technical data

3-phase mains connection 480 V

Terminal data



PE connection					
Inverter		i510-C1.5/400-3	i510-C2.2/400-3	i510-C3.0/400-3	i510-C4.0/400-3
Connection		PE			
Connection type		PE screw			
Max. Cable cross-section	mm ²	6	6	6	6
Max. Cable cross-section	AWG	10	10	10	10
Stripping length	mm	10	10	10	10
Stripping length	inch	0.39	0.39	0.39	0.39
Tightening torque	Nm	2	2	2	2
Tightening torque	lb-in	18	18	18	18
Required tool		Torx 20			

PE connection					
Inverter		i510-C5.5/400-3	i510-C7.5/400-3	i510-C11/400-3	
Connection		PE			
Connection type		PE screw			
Max. Cable cross-section	mm ²	6	16	16	
Max. Cable cross-section	AWG	10	6	6	
Stripping length	mm	10	11	11	
Stripping length	inch	0.39	0.43	0.43	
Tightening torque	Nm	2	3.4	3.4	
Tightening torque	lb-in	18	30	30	
Required tool		Torx 20	PZ2		

Motor connection					
Inverter		i510-C0.37/400-3	i510-C0.55/400-3	i510-C0.75/400-3	i510-C1.1/400-3
Connection		X105			
Connection type		pluggable screw terminal			
Max. Cable cross-section	mm ²	2.5	2.5	2.5	2.5
Max. Cable cross-section	AWG	12	12	12	12
Stripping length	mm	8	8	8	8
Stripping length	inch	0.32	0.32	0.32	0.32
Tightening torque	Nm	0.5	0.5	0.5	0.5
Tightening torque	lb-in	4.4	4.4	4.4	4.4
Required tool		0.5 x 3.0			

Motor connection					
Inverter		i510-C1.5/400-3	i510-C2.2/400-3	i510-C3.0/400-3	i510-C4.0/400-3
Connection		X105			
Connection type		pluggable screw terminal		Screw terminal	
Max. Cable cross-section	mm ²	2.5	2.5	6	6
Max. Cable cross-section	AWG	12	12	10	10
Stripping length	mm	8	8	9	9
Stripping length	inch	0.32	0.32	0.35	0.35
Tightening torque	Nm	0.5	0.5	0.5	0.5
Tightening torque	lb-in	4.4	4.4	4.4	4.4
Required tool		0.5 x 3.0		0.6 x 3.5	



Technical data

3-phase mains connection 480 V
Mains chokes

Motor connection				
Inverter		i510-C5.5/400-3	i510-C7.5/400-3	i510-C11/400-3
Connection		X105		
Connection type		Screw terminal		
Max. Cable cross-section	mm ²	6	16	16
Max. Cable cross-section	AWG	10	6	6
Stripping length	mm	9	11	11
Stripping length	inch	0.35	0.43	0.43
Tightening torque	Nm	0.5	1.2	1.2
Tightening torque	lb-in	4.4	11	11
Required tool		0.6 x 3.5		0.8 x 4.0

Mains chokes

Inverter	Order code	Number of phases	Mains choke				
			Rated current	Inductance	Dimensions (h x w x d)	Weight	
			A	mH	mm	kg	
i510-C0.37/400-3	EZAELN3002B203	3	1.5	19.6	56 x 77 x 100	0.52	
i510-C0.55/400-3	EZAELN3002B153		2	14.7		0.53	
i510-C0.75/400-3	EZAELN3004B742		4	7.35	60 x 95 x 115	1.31	
i510-C1.1/400-3			EZAELN3006B492	6	4.9	69 x 95 x 120	1.45
i510-C1.5/400-3				8	3.68	85 x 120 x 140	1.9
i510-C2.2/400-3	EZAELN3016B182		16	1.84	95 x 120 x 140	2.7	
i510-C3.0/400-3			EZAELN3008B372	20	1.47	95 x 155 x 165	3.8
i510-C4.0/400-3							
i510-C5.5/400-3							
i510-C7.5/400-3							
i510-C11/400-3	EZAELN3020B152						

Technical data

3-phase mains connection 480 V
RFI filters / Mains filters



RFI filters / Mains filters

Basic information on RFI filters, mains filters and EMC: from [147](#)



EMC filters can be used both in the side structure and in the substructure.

Maximum motor cable lengths and FI operation

Mains connection			3-phase, 400 V/480 V			
Inverter			i510-C0.37/400-3	i510-C0.55/400-3 i510-C0.75/400-3	i510-C1.1/400-3 i510-C1.5/400-3 i510-C2.2/400-3	i510-C3.0/400-3 i510-C4.0/400-3 i510-C5.5/400-3 i510-C7.5/400-3 i510-C11/400-3
With integrated RFI filter						
Without EMC category Thermal limitation	Shielded motor cable length	m	15	50	50	100
	Unshielded motor cable length	m	30	100	200	200
With integrated RFI filter						
Category C1	Shielded motor cable length	m	-	-	-	-
Category C2		m	15	15	20	20
	Earth-leakage circuit breaker	mA	30	30	30	300
RFI filter Low Leakage						
Category C1	Shielded motor cable length	m	-	-	-	-
	Earth-leakage circuit breaker	mA	-	-	-	-
RFI filter Short Distance						
Category C1	Shielded motor cable length	m	15	25	25	25
Category C2		m	15	50	50	50
	Earth-leakage circuit breaker	mA	30	30	30	30
RFI filter Long Distance						
Category C1	Shielded motor cable length	m	15	50	50	50
Category C2		m	15	50	50	100
	Earth-leakage circuit breaker	mA	300	300	300	300

Short Distance

Inverter	RFI filter		
	Order code	Dimensions (h x w x d)	Weight
		mm	kg
i510-C0.37/400-3	IOFAE175F100S0000S	276 x 60 x 50	0.9
i510-C0.55/400-3			
i510-C0.75/400-3			
i510-C1.1/400-3	IOFAE222F100S0000S	346 x 60 x 50	1.1
i510-C1.5/400-3			
i510-C2.2/400-3			
i510-C3.0/400-3	IOFAE255F100S0001S	346 x 90 x 60	2.1
i510-C4.0/400-3			
i510-C5.5/400-3			
i510-C7.5/400-3	IOFAE311F100S0000S	371 x 120 x 60	2.4
i510-C11/400-3			



Technical data

3-phase mains connection 480 V
RFI filters / Mains filters

Long Distance

Inverter	RFI filter		
	Order code	Dimensions (h x w x d)	Weight
		mm	kg
i510-C0.37/400-3	IOFAE175F100D0000S	276 x 60 x 50	0.9
i510-C0.55/400-3			
i510-C0.75/400-3			
i510-C1.1/400-3	IOFAE222F100D0000S	346 x 60 x 50	1.1
i510-C1.5/400-3			
i510-C2.2/400-3			
i510-C3.0/400-3	IOFAE255F100D0001S	346 x 90 x 60	1.7
i510-C4.0/400-3			
i510-C5.5/400-3			
i510-C7.5/400-3	IOFAE311F100D0000S	371 x 120 x 60	2.1
i510-C11/400-3			

Technical data

3-phase mains connection 480 V "Light Duty"

Rated data



3-phase mains connection 480 V "Light Duty"

Rated data

The output currents apply to these operating conditions:

- At a switching frequency of 2 kHz or 4 kHz: Ambient temperature above 40 °C with a rated output current reduced by 2.5 %/°C.
- If the load characteristic "Light Duty" and the switching frequencies 8 kHz or 16 kHz are selected, only the values of the load characteristic "Heavy Duty" are reached.

Inverter		i510-C3.0/400-3	i510-C4.0/400-3	i510-C5.5/400-3	i510-C7.5/400-3
Rated power	kW	4	5.5	7.5	11
Rated power	hp	5	7.5	10	15
Mains voltage range		3/PE AC 340 V ... 528 V, 45 Hz ... 65 Hz			
Output voltage		3 AC 0-400/480 V			
Rated mains current					
without mains choke	A	8.6	11.2	15.3	22
with mains choke	A	6.8	8.8	12.1	17.2
Apparent output power	kVA	5.9	8	10.5	15
Rated output current					
2 kHz	A	7.6	9.8	13.2	18.3
4 kHz	A	7.6	9.8	13.2	18.3
8 kHz	A	-	-	-	-
16 kHz	A	-	-	-	-
Power loss					
2 kHz	W	94	125	163	238
4 kHz	W	100	133	173	253
8 kHz	W	-	-	-	-
16 kHz	W	-	-	-	-
at inverter disablecontroller inhibit	W	6	6	6	6
Overcurrent cycle 180 s					
Max. Output current	A	9.5	12.3	16.5	21
Overload time	s	60	60	60	60
Recovery time	s	120	120	120	120
Max. output current during the recovery time	A	4.8	6.2	8.3	10.5
Overcurrent cycle 15 s					
Max. Output current	A	12.6	16.4	22	28
Overload time	s	3	3	3	3
Recovery time	s	12	12	12	12
Max. output current during the recovery time	A	4.7	6.2	8.3	10.5
Cyclic mains switching		3 times per minute			
Brake chopper					
Max. Output current	A	-	-	-	-
Min. Brake resistor	Ω	-	-	-	-
Max. Shielded motor cable length					
Category C2 (2 kHz, 4 kHz, 8 kHz)	m	20	20	20	20
Category C3 (2 kHz, 4 kHz, 8 kHz)	m	35	35	35	50
without EMC category	m	100	100	100	100
Weight	kg	2.3	2.3	2.3	3.7
Weight	lb	5	5	5	8



Technical data

3-phase mains connection 480 V "Light Duty"
Rated data

Inverter		i510-C11/400-3
Rated power	kW	15
Rated power	hp	20
Mains voltage range		3/PE AC 340 V ... 528 V, 45 Hz ... 65 Hz
Output voltage		3 AC 0-400/480 V
Rated mains current		
without mains choke	A	-
with mains choke	A	22.6
Apparent output power	kVA	19
Rated output current		
2 kHz	A	25.2
4 kHz	A	25.2
8 kHz	A	-
16 kHz	A	-
Power loss		
2 kHz	W	290
4 kHz	W	309
8 kHz	W	-
16 kHz	W	-
at inverter disablecontroller inhibit	W	6
Overcurrent cycle 180 s		
Max. Output current	A	31.5
Overload time	s	60
Recovery time	s	120
Max. output current during the recovery time	A	15.8
Overcurrent cycle 15 s		
Max. Output current	A	42
Overload time	s	3
Recovery time	s	12
Max. output current during the recovery time	A	15.8
Cyclic mains switching		3 times per minute
Brake chopper		
Max. Output current	A	-
Min. Brake resistor	Ω	-
Max. Shielded motor cable length		
Category C2 (2 kHz, 4 kHz, 8 kHz)	m	20
Category C3 (2 kHz, 4 kHz, 8 kHz)	m	50
without EMC category	m	100
Weight	kg	3.7
Weight	lb	8

Technical data

3-phase mains connection 480 V "Light Duty"

Fusing data



Fusing data

Fusing data					
Inverter		i510-C3.0/400-3	i510-C4.0/400-3	i510-C5.5/400-3	i510-C7.5/400-3
Cable installation in compliance with		EN 60204-1			
without mains choke					
Circuit breaker					
Characteristics		B			
Max. Rated current	A	25	25	25	32
Fuse					
Characteristics		gG/gL or gRL			
Max. Rated current	A	25	25	25	32
with mains choke					
Circuit breaker					
Characteristics		B			
Max. Rated current	A	25	25	25	32
Fuse					
Characteristics		gG/gL or gRL			
Max. Rated current	A	25	25	25	32
Earth-leakage circuit breaker					
3-phase mains connection		≥ 300 mA, type B			

Fusing data					
Inverter		i510-C11/400-3			
Cable installation in compliance with		EN 60204-1			
without mains choke					
Circuit breaker					
Characteristics		-			
Max. Rated current	A	-			
Fuse					
Characteristics		-			
Max. Rated current	A	-			
with mains choke					
Circuit breaker					
Characteristics		B			
Max. Rated current	A	32			
Fuse					
Characteristics		gG/gL or gRL			
Max. Rated current	A	32			
Earth-leakage circuit breaker					
3-phase mains connection		≥ 300 mA, type B			



Technical data

3-phase mains connection 480 V "Light Duty"
Fusing data



The values given below refer to the minimum SCCR values. The actual possible values for the UL fuse data (High SCCR) can be found in the appendix at: [▶ UL fuses \(High SCCR\)](#) [□ 153](#)

Fusing data					
Inverter		i510-C3.0/400-3	i510-C4.0/400-3	i510-C5.5/400-3	i510-C7.5/400-3
Cable installation in compliance with		US National Electrical Code NFPA 70 / Canadian Electrical Code C22.1			
without mains choke					
Circuit breaker					
Characteristics		all acc. to UL 489			
Max. Rated current	A	25	25	25	35
Fusing type		Standard fusing			
SCCR: Requirement		Standard short-circuit strength			
SCCR: Max. Short-circuit current	kA	5	5	5	5
SCCR: Voltage		480/277 Volts Maximum			
Fuse					
Characteristics		all acc. to UL 248 / Class CC			all acc. to UL 248 / Class J, T, R
Max. Rated current	A	25	25	25	40
Fusing type		Standard fusing			
SCCR: Requirement		Standard short-circuit strength			
SCCR: Max. Short-circuit current	kA	5	5	5	5
SCCR: Voltage		480/277 Volts Maximum			
with mains choke					
Circuit breaker					
Characteristics		all acc. to UL 489			
Max. Rated current	A	25	25	25	35
Fusing type		Standard fusing			
SCCR: Requirement		Standard short-circuit strength			
SCCR: Max. Short-circuit current	kA	5	5	5	5
SCCR: Voltage		480/277 Volts Maximum			
Fuse					
Characteristics		all acc. to UL 248 / Class CC			all acc. to UL 248 / Class J, T, R
Max. Rated current	A	25	25	25	40
Fusing type		Standard fusing			
SCCR: Requirement		Standard short-circuit strength			
SCCR: Max. Short-circuit current	kA	5	5	5	5
SCCR: Voltage		480/277 Volts Maximum			
Earth-leakage circuit breaker					
3-phase mains connection		≥ 300 mA, type B			

Technical data

3-phase mains connection 480 V "Light Duty"
Fusing data



Fusing data		
Inverter		i510-C11/400-3
Cable installation in compliance with		US National Electrical Code NFPA 70 / Canadian Electrical Code C22.1
without mains choke		
Circuit breaker		
Characteristics		-
Max. Rated current	A	-
Fusing type		-
SCCR: Requirement		-
SCCR: Max. Short-circuit current	kA	-
SCCR: Voltage		-
Fuse		
Characteristics		-
Max. Rated current	A	-
Fusing type		-
SCCR: Requirement		-
SCCR: Max. Short-circuit current	kA	-
SCCR: Voltage		-
with mains choke		
Circuit breaker		
Characteristics		-
Max. Rated current	A	-
Fusing type		-
SCCR: Requirement		-
SCCR: Max. Short-circuit current	kA	-
SCCR: Voltage		-
Fuse		
Characteristics		all acc. to UL 248 / Class J, T, R
Max. Rated current	A	40
Fusing type		Standard fusing
SCCR: Requirement		Standard short-circuit strength
SCCR: Max. Short-circuit current	kA	5
SCCR: Voltage		480/277 Volts Maximum
Earth-leakage circuit breaker		
3-phase mains connection		≥ 300 mA, type B



Technical data

3-phase mains connection 480 V "Light Duty"
Terminal data

Terminal data

Mains connection					
Inverter		i510-C3.0/400-3	i510-C4.0/400-3	i510-C5.5/400-3	i510-C7.5/400-3
Connection		X100			
Connection type		Screw terminal			
Max. Cable cross-section	mm ²	6	6	6	16
Max. Cable cross-section	AWG	10	10	10	6
Stripping length	mm	9	9	9	11
Stripping length	inch	0.35	0.35	0.35	0.43
Tightening torque	Nm	0.5	0.5	0.5	1.2
Tightening torque	lb-in	4.4	4.4	4.4	11
Required tool		0.6 x 3.5			0.8 x 4.0

Mains connection	
Inverter	i510-C11/400-3
Connection	X100
Connection type	Screw terminal
Max. Cable cross-section	mm ² 16
Max. Cable cross-section	AWG 6
Stripping length	mm 11
Stripping length	inch 0.43
Tightening torque	Nm 1.2
Tightening torque	lb-in 11
Required tool	0.8 x 4.0

PE connection					
Inverter		i510-C3.0/400-3	i510-C4.0/400-3	i510-C5.5/400-3	i510-C7.5/400-3
Connection		PE			
Connection type		PE screw			
Max. Cable cross-section	mm ²	6	6	6	16
Max. Cable cross-section	AWG	10	10	10	6
Stripping length	mm	10	10	10	11
Stripping length	inch	0.39	0.39	0.39	0.43
Tightening torque	Nm	2	2	2	3.4
Tightening torque	lb-in	18	18	18	30
Required tool		Torx 20			PZ2

PE connection	
Inverter	i510-C11/400-3
Connection	PE
Connection type	PE screw
Max. Cable cross-section	mm ² 16
Max. Cable cross-section	AWG 6
Stripping length	mm 11
Stripping length	inch 0.43
Tightening torque	Nm 3.4
Tightening torque	lb-in 30
Required tool	PZ2

Technical data

3-phase mains connection 480 V "Light Duty"
Mains chokes



Motor connection					
Inverter		i510-C3.0/400-3	i510-C4.0/400-3	i510-C5.5/400-3	i510-C7.5/400-3
Connection		X105			
Connection type		Screw terminal			
Max. Cable cross-section	mm ²	6	6	6	16
Max. Cable cross-section	AWG	10	10	10	6
Stripping length	mm	9	9	9	11
Stripping length	inch	0.35	0.35	0.35	0.43
Tightening torque	Nm	0.5	0.5	0.5	1.2
Tightening torque	lb-in	4.4	4.4	4.4	11
Required tool		0.6 x 3.5			0.8 x 4.0

Motor connection					
Inverter		i510-C11/400-3			
Connection		X105			
Connection type		Screw terminal			
Max. Cable cross-section	mm ²	16			
Max. Cable cross-section	AWG	6			
Stripping length	mm	11			
Stripping length	inch	0.43			
Tightening torque	Nm	1.2			
Tightening torque	lb-in	11			
Required tool		0.8 x 4.0			

Mains chokes

Inverter	Order code	Number of phases	Mains choke			
			Rated current	Inductance	Dimensions (h x w x d)	Weight
			A	mH	mm	kg
i510-C3.0/400-3	EZAELN3008B372	3	8	3.68	85 x 120 x 140	1.9
i510-C4.0/400-3	EZAELN3010B292		10	2.94		2
i510-C5.5/400-3	EZAELN3016B182		16	1.84	95 x 120 x 140	2.7
i510-C7.5/400-3	EZAELN3020B152		20	1.47	95 x 155 x 165	3.8
i510-C11/400-3	EZAELN3025B122		25	1.18	110 x 155 x 170	5.8



RFI filters / Mains filters

Basic information on RFI filters, mains filters and EMC: from [147](#)



EMC filters can be used both in the side structure and in the substructure.

Maximum motor cable lengths and FI operation

Mains connection		3-phase, 400 V/480 V	
Inverter		i510-C3.0/400-3 i510-C4.0/400-3 i510-C5.5/400-3 i510-C7.5/400-3 i510-C11/400-3	
With integrated RFI filter			
Without EMC category Thermal limitation	Shielded motor cable length	m	100
	Unshielded motor cable length	m	200
With integrated RFI filter			
Category C1	Shielded motor cable length	m	-
Category C2		m	20
	Earth-leakage circuit breaker	mA	300
RFI filter Low Leakage			
Category C1	Shielded motor cable length	m	-
	Earth-leakage circuit breaker	mA	-
RFI filter Short Distance			
Category C1	Shielded motor cable length	m	25
Category C2		m	50
	Earth-leakage circuit breaker	mA	30
RFI filter Long Distance			
Category C1	Shielded motor cable length	m	50
Category C2		m	100
	Earth-leakage circuit breaker	mA	300

Short Distance

Inverter	RFI filter		
	Order code	Dimensions (h x w x d)	Weight
		mm	kg
i510-C3.0/400-3	IOFAE255F100S0001S	346 x 90 x 60	2.1
i510-C4.0/400-3			
i510-C5.5/400-3			
i510-C7.5/400-3	IOFAE311F100S0000S	371 x 120 x 60	2.4
i510-C11/400-3			

Long Distance

Inverter	RFI filter		
	Order code	Dimensions (h x w x d)	Weight
		mm	kg
i510-C3.0/400-3	IOFAE255F100D0001S	346 x 90 x 60	1.7
i510-C4.0/400-3			
i510-C5.5/400-3			
i510-C7.5/400-3	IOFAE311F100D0000S	371 x 120 x 60	2.1
i510-C11/400-3			

Technical data

Dimensions



Dimensions

0.25 kW ... 0.37 kW

The dimensions in mm apply to:

0.25 kW	i510-CO.25/230-1	i510-CO.25/230-2	
0.37 kW	i510-CO.37/230-1	i510-CO.37/230-2	i510-CO.37/400-3

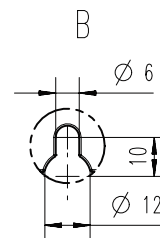
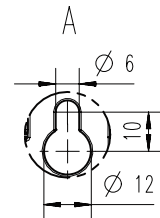
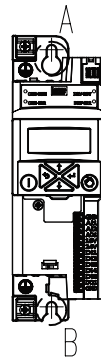
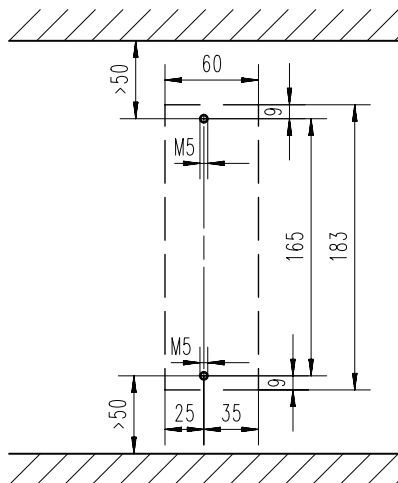
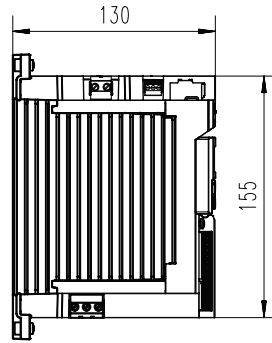
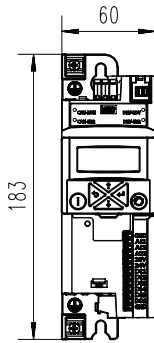

8800270



0.55 kW ... 0.75 kW

The dimensions in mm apply to:

0.55 kW	i510-CO.55/230-1	i510-CO.55/230-2	i510-CO.55/400-3
0.75 kW	i510-CO.75/230-1	i510-CO.75/230-2	i510-CO.75/400-3

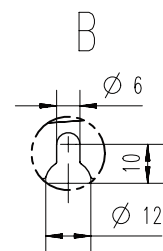
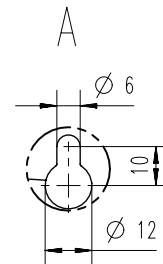
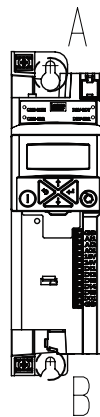
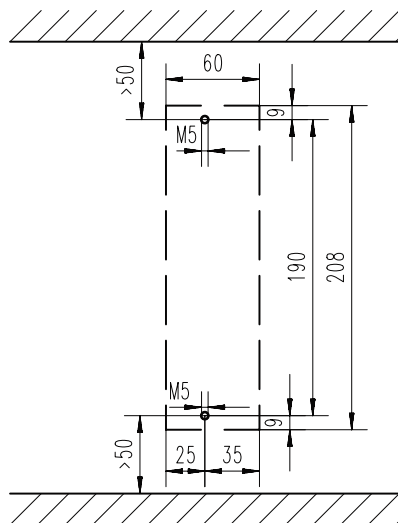
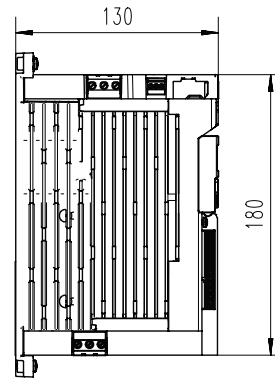
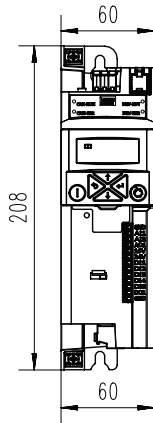

8800271

Technical data

Dimensions



1.1 kW ... 2.2 kW

The dimensions in mm apply to:

1.1 kW	i510-C1.1/230-1	i510-C1.1/230-2	i510-C1.1/400-3
1.5 kW	i510-C1.5/230-1	i510-C1.5/230-2	i510-C1.5/400-3
2.2 kW	i510-C2.2/230-1	i510-C2.2/230-2	i510-C2.2/400-3

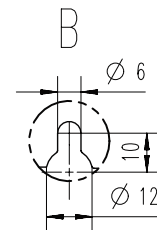
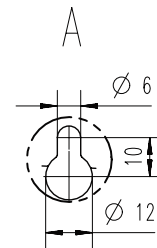
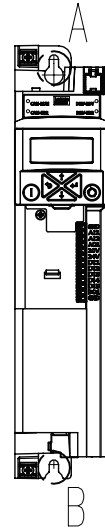
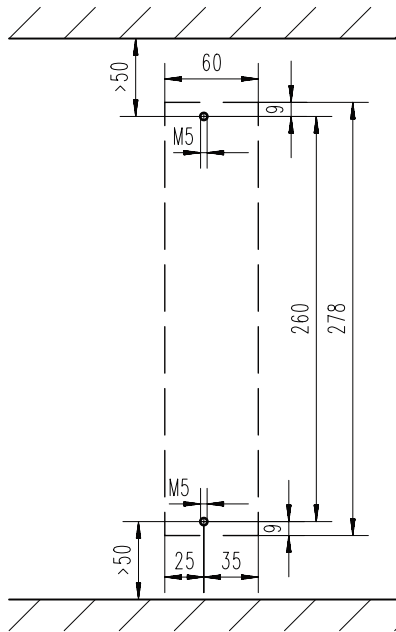
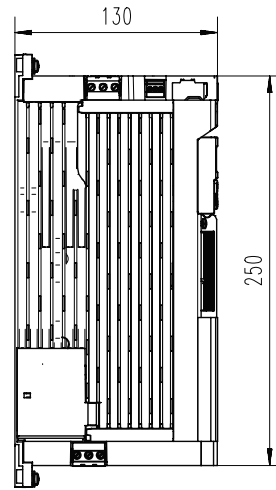
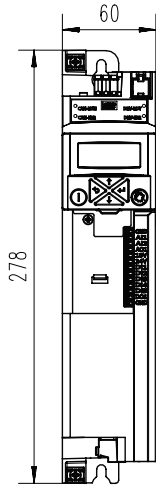

8800272



Technical data

Dimensions

3 kW ... 5.5 kW

The dimensions in mm apply to:

3 kW		i510-C3.0/400-3
4 kW	i510-C4.0/230-3	i510-C4.0/400-3
5.5 kW	i510-C5.5/230-3	i510-C5.5/400-3

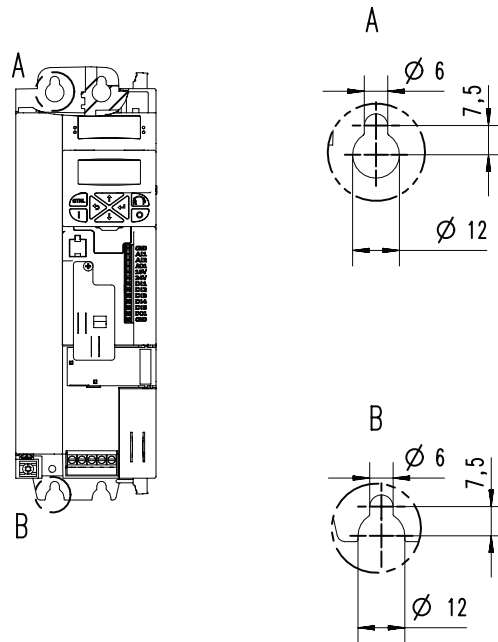
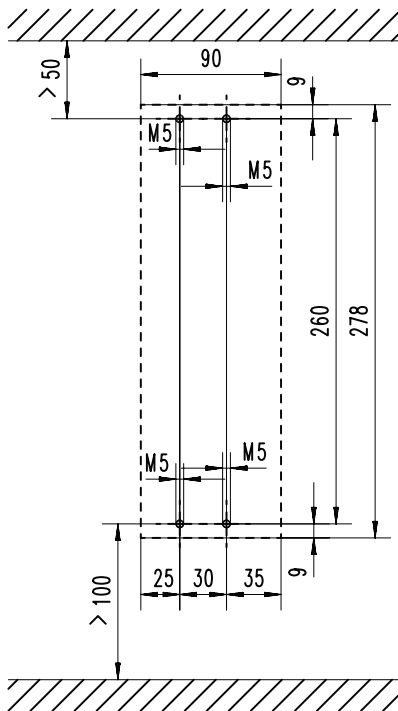
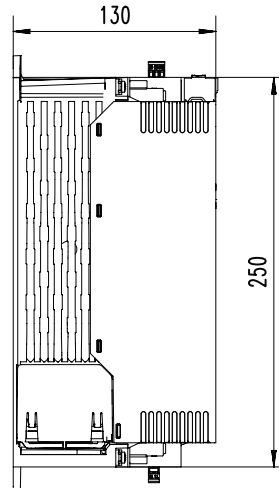
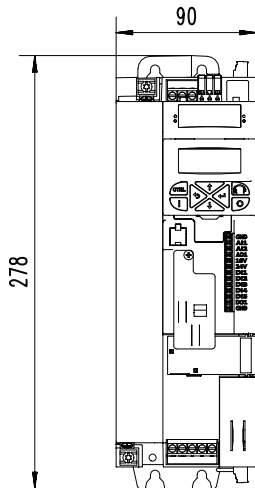

8800599

Technical data

Dimensions



7.5 kW ... 11 kW

The dimensions in mm apply to:

7.5 kW	i510-C7.5/400-3
11 kW	i510-C11/400-3

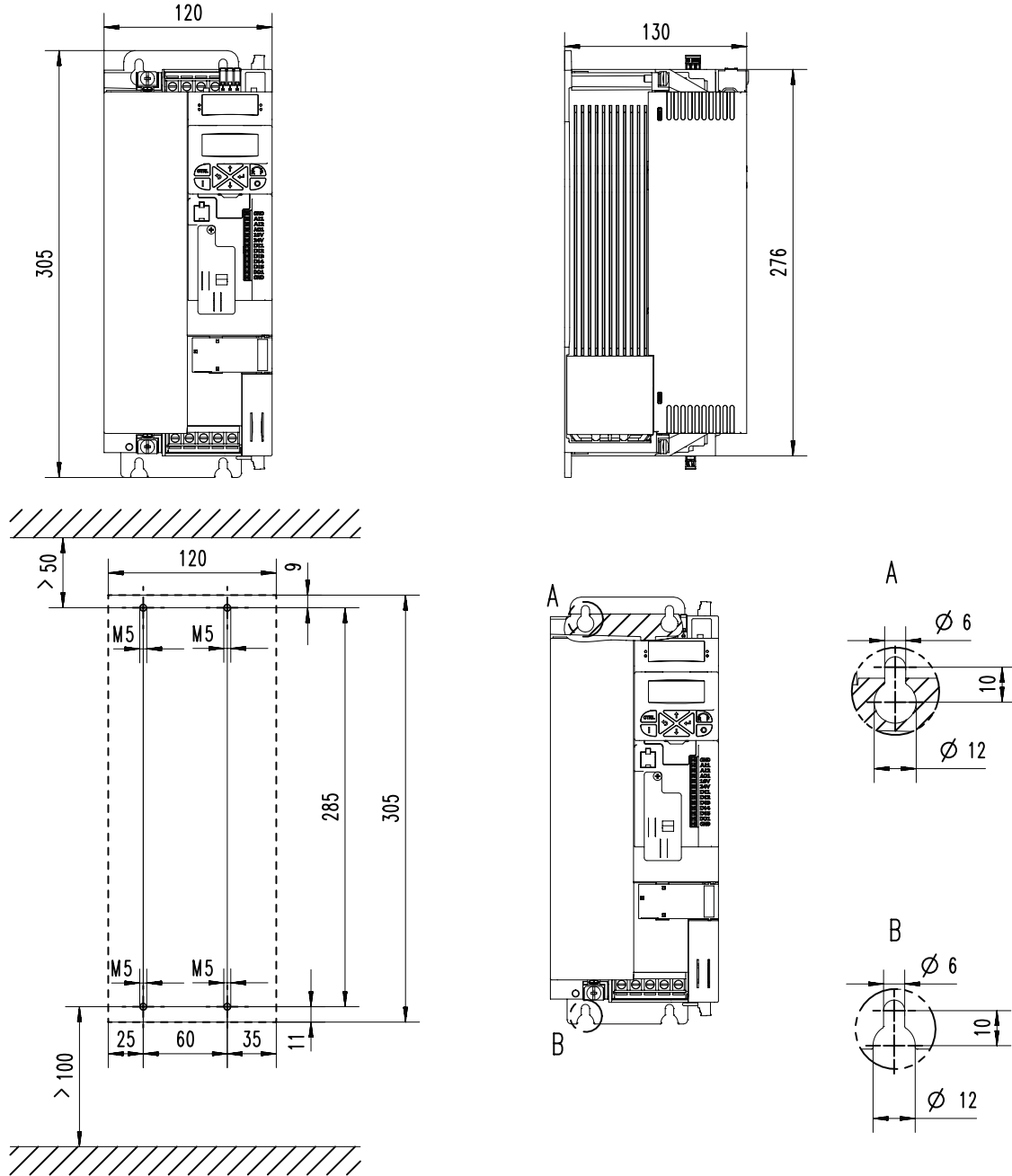

8800600



Product extensions

Overview

The inverters are supplied as complete devices. A control unit with basic I/O is integrated.

As the control unit cannot be extended, the inverter i510 is available in two versions:

- With CANopen/Modbus, switchable.
- Without network.

The inverters can easily be integrated into the machine. The scalable product extensions serve to flexibly match the required functions to your application.



Inverter
without network



Inverter
with CANopen and Modbus

Product extensions

I/O extensions
Basic I/Os



I/O extensions

Basic I/Os

The basic I/O provides the inverter analog and digital inputs and outputs and is designed for simple applications.

The basic I/O can be purchased with or without the CANopen and Modbus networks. A switch can be used to select between the two networks.

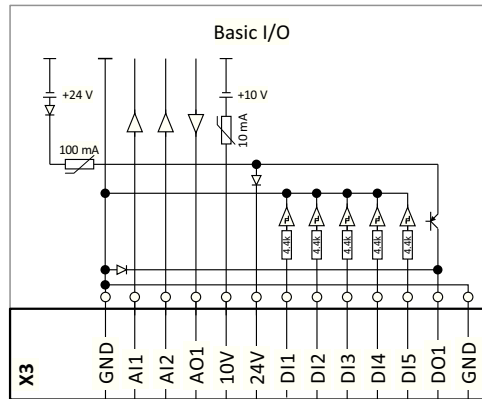

Digital inputs	Terminal X3: DI1, DI2, DI3, DI4, DI5	HIGH active
Digital outputs	Terminal X3: DO1	
Analog inputs	Terminal X3: AI1, AI2	AI1: Can be optionally used as voltage or current input. AI2: Can be used as voltage input.
Analog output	Terminal X3: AO1	Can be optionally used as voltage or current output.
10-V output	Terminal X3: 10V	Reference voltage or setpoint potentiometer
24-V output	Terminal X3: 24V	
Reference potential	Terminal X3: GND	
Connection system	Pluggable spring terminal	



Data of control connections

Digital inputs

Switching type		PNP	
PNP switching level			
LOW	V	< +5	IEC 61131-2, type 1
HIGH	V	> +15	
Input resistance	kΩ	4.6	
Cycle time	ms	1	can be changed by software filtering
Electric strength of external voltage	V	± 30	

Digital outputs

Switching level			
LOW	V	< +5	IEC 61131-2, type 1
HIGH	V	> +15	
max. output current	mA	100	Total current for DO1 and 24V
Cycle time	ms	1	
Short-circuit strength		Unlimited period	
Electric strength of external voltage	V	± 30	
Polarity reversal protection		Integrated freewheeling diode for switching the inductive load	
Overload behaviour		Reduced voltage or periodic switch-off/on	
Reset or switch-on behaviour		Output is switched off	LOW

Analog inputs

Cycle time	ms	1	
Resolution of A/D converter	Bit	12	
Operation as voltage input			
Connection designation		X3/AI1, X3/AI2	
Input voltage DC	V	0 ... 10	
Input resistance	kΩ	70	
Accuracy	mV	± 50	Typical
Input voltage in case of open circuit	V	- 0.2 ... 0.2	Display "0"
Electric strength of external voltage	V	± 24	
Operation as current input			
Connection designation		X3/AI1, X3/AI2	
Input current	mA	0 ... 20	
		4 ... 20	open-circuit monitored
Accuracy	mA	± 0.1	Typical
Input current in case of open circuit	mA	< 0.1	Display "0"
Input resistance	Ω	< 250	
Electric strength of external voltage	V	± 24	

Product extensions

I/O extensions
Data of control connections



Analog outputs

Short-circuit strength		Unlimited period	
Electric strength of external voltage	V	+ 24V	
Operation as voltage output			
Resolution of D/A converter	Bit	12	
Output voltage DC	V	0 ... 10	
max. output current	mA	5	
min. load resistance	kΩ	≥ 2.2	
max. capacitive load	μF	1	
Accuracy	mV	± 100	Typical
Operation as current output			
Output current	mA	0 ... 20	
		4 ... 20	open-circuit monitored
Accuracy	mA	± 0.3	Typical

10-V output

Use		Primarily for the supply of a potentiometer (1 ... 10 kΩ)	
Output voltage DC			
Typical	V	10	
Accuracy	mV	± 100	
Max. output current	mA	10	
Max. capacitive load	μF	1	
Short-circuit strength		Unlimited period	
Electric strength of external voltage	V	+ 24	

24-V output

Use		Primarily for the supply of digital inputs	
Output voltage DC			
Typical	V	24	
Area	V	16 ... 28	
max. output current	mA	100	Total current for DO... and 24V
Short-circuit strength		Unlimited period	
Electric strength of external voltage	V	+ 30	
Excess current release		Automatically resettable	



Further control connections

Terminal description		Relay output	
Connection		X9	
Connection type		pluggable screw terminal	
Max. Cable cross-section	mm ²	1.5	1.5
Max. Cable cross-section	AWG	14	14
Stripping length	mm	6	6
Stripping length	inch	0.24	0.24
Tightening torque	Nm	0.2	0.2
Tightening torque	lb-in	1.8	1.8
Required tool		0.4 x 2.5	

Relay output



Relay is not suitable for direct switching of a electromechanical holding brake!

Use a corresponding suppressor circuit in case of an inductive or capacitive load!

Connection		Terminal X9: COM	Centre contact (common)
		Terminal X9: NC	NC contact (normally closed)
		Terminal X9: NO	NO contact (normally open)
Minimum DC contact load			
	Voltage	V	10
	Current	mA	10
A correct switching of the relay contacts needs both values to be exceeded simultaneously.			
Switching voltage/switching current			
Maximum	AC 240 V	A	3
	DC 24 V	A	2
	DC 240 V	A	0.16
According to UL: General Purpose			
According to UL: Resistive			

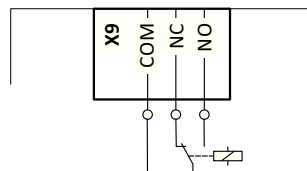

Product extensions

Networks
CANopen/Modbus



Networks

The integrated standard product extension for the inverter i510 is the control unit with basic I/O.

As the control unit cannot be extended, the inverter i510 is available in two versions:

- With CANopen/Modbus, switchable.
- Without network.

CANopen

CANopen is an internationally approved communication protocol which is designed for commercial and industrial automation applications. High data transfer rates in connection with efficient data formatting provide for the coordination of motion control devices in multi-axis applications.

Technical data			
Bus terminating resistor	Ω	120	Terminated on both sides
integrated bus terminating resistor		Yes	Activation via DIP switch
Network topology			
without repeater		Line	
with repeater		Line or tree	
Station			
Type		Slave	
Max. number without repeater		127	per bus segment, incl. host system
Address		1 ... 127	Adjustable via code or DIP switch
Baud rate	kbps	20, 50, 125, 250, 500, 800 or 1000	Adjustable via code or DIP switch
Max. bus length	m	2500, 1000, 500, 250, 100, 50 or 25	Total cable length depends on the baud rate
Max. cable length between two nodes		not limited, the max. bus length is decisive	
Process data			
Transmit PDOs		3 TPDOs with 1 ... 8 bytes (adjustable)	
Receive PDOs		3 RPDOs with 1 ... 8 bytes (adjustable)	
Transmission mode for TPDOs			
With change of data		Yes	
Time-controlled, multiple of	ms	10	
After reception		1 ... 240 sync telegrams	
Parameter data			
SDO channels		Max. 2 servers	

CANopen/Modbus

General information			
Version		Inverter version	<ul style="list-style-type: none"> • No retrofitting possible. • Integrated in the complete device.
Mains-dependent voltage supply of the control electronics and optional fieldbus		Internally via the inverter	
Mains-independent voltage supply		Not possible	



Modbus RTU

Modbus is an internationally approved, asynchronous, serial communication protocol, designed for commercial and industrial automation applications.

Technical data			
Communication profile		Modbus RTU	
Bus terminating resistor	Ω	120	Terminated on both sides
Integrated bus terminating resistor		Yes	Activation via DIP switch
Network topology			
Without repeater		Line	
Station			
Type		Slave	
Max. number without repeater		32	Per bus segment, incl. host system
Max. number with repeater		90	
Address		1 ... 247	Adjustable via code or DIP switch
Transfer rate	kbps	4.8 ... 115	Adjustable via code or DIP switch, alternatively automatic detection via DIP switch can be activated
Max. cable length	m	12 ... 600	Per bus segment, depending on the transfer rate and the cable type used
Max. cable length between two nodes		not limited, the max. bus length is decisive	
Data channel			
SDO channels		Max. 2 servers, with 1 ... 8 bytes	Supported functions: Read Holding Registers Preset Single Register Preset Multiple Registers Read/Write 4 x registers



Accessories

Overview

A package of accessories optimally matched to the inverter is available for your applications.

Moreover, the pluggable modules make commissioning and diagnostics easier.

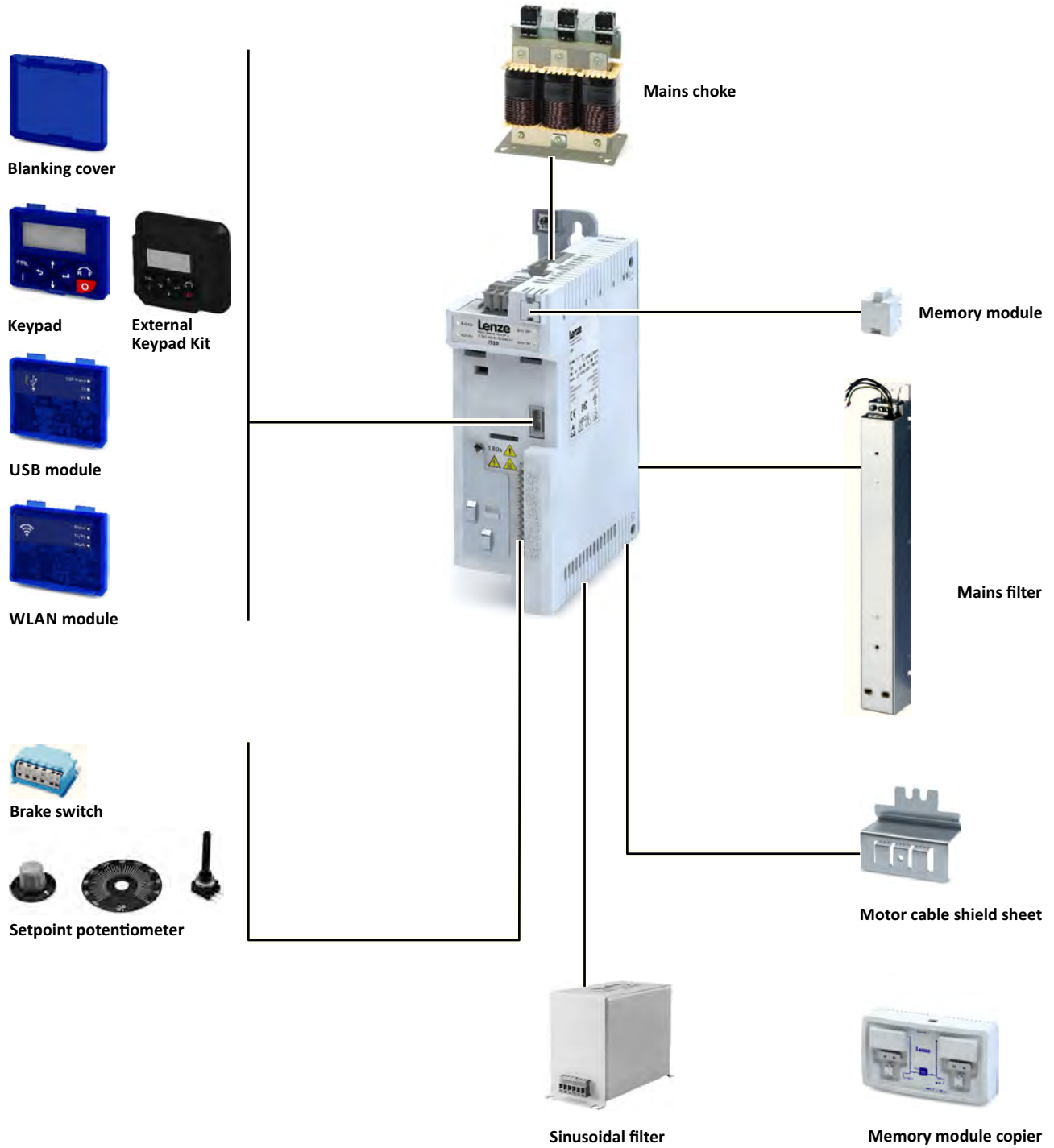



Operation and diagnostics

Keypad

Parameter setting and diagnostics

Thanks to the intuitive operating structure, the navigation keys allow a quick and easy access to the most important parameters, either to configure functions or to query current values. Parameters and actual values are indicated on the easy-to-read display.



Keypad	
Order code	Type
I5MADK0000000S	16-digit LED display Display in German/English

External keypad

Installation in user interface

The external keypad kit facilitates installation of a I5MADK0000000S keypad in an IP65 housing for mounting to the control cabinet wall.



External keypad kit	
Order code	Type
I5MADR0000000S	without connecting cable
I5MADR0000001S	with connecting cable 3 m
I5MADR0000002S	with connecting cable 5 m
The I5MADK0000000S keypad is not part of the delivery.	

Accessories

Operation and diagnostics
USB module



USB module

Interface to the PC

Connect the inverter via a USB 2.0 connection cable to a PC on which the Lenze "EASY Starter" engineering tool is installed. Configure the inverter with the "EASY Starter" using graphical user interfaces. You can create diagnostics with trend functions or observe parameter values.

Parameterising without supplying the inverter with voltage: in many cases, the USB interface of the PC is sufficient for the voltage supply if you connect the inverter directly to the PC without a hub.



USB module	
Order code	Type
I5MADU0000000S	Parameter setting without voltage supply of the inverter is possible. USB 2.0 connecting cable required

Connecting cable		
Order code	Length	Type
EWL0085/S	3 m	USB 2.0-connecting cable (A-plug to micro B-plug)
EWL0086/S	5 m	



WLAN module

Communicate with the inverter wirelessly,

- via a PC with the "EASY Starter" Lenze Engineering Tool or
- via the Lenze Smart Keypad app for Android and iOS smartphones.

The app is recommended for adapting easy applications. The clearly arranged user interface of the app guides you intuitively and safely through all the menus. The operation corresponds to the operation with the keypad.



WARNING!

- ▶ This product contains FCC ID: QQQWF121/IC: 5123A-BGTWF121
- ▶ To comply with FCC and Industry Canada RF radiation exposure limits for general population, the transmitter with its antenna must be installed such that a minimum separation distance of 20 cm is maintained between the radiator (antenna) and all persons at all times.
- ▶ This product must not be collocated or operated in conjunction with any other antenna or transmitter.
- ▶ -----
- ▶ Le produit contient un module transmetteur certifié FCC ID: QQQWF121/IC: 5123A-BGTWF121
- ▶ Afin de se conformer aux réglementations de la FCC et d'Industry Canada relatives aux limites d'exposition aux rayonnements RF pour le grand public, le transmetteur et son antenne doivent être installés de sorte qu'une distance minimale de 20 cm soit constamment maintenue entre le radiateur (antenne) et toute personne.
- ▶ Le produit ne doit pas être utilisé en combinaison avec d'autres antennes ou transmetteurs.



The use of this module may be restricted or prohibited due to country-specific provisions or additionally required certifications.

The module has been certified according to:

- CE
- FCC
- IC
- CMIIT

The module can be used if the certification is recognised in one country according to one of these standards.

Accessories

Operation and diagnostics

WLAN module



LED status displays			
LED 1	LED 2	LED 3	Meaning
Power (green)	TX/RX (yellow)	WLAN (green)	
Supply voltage status	Communication status	WLAN status	
OFF	OFF	OFF	No voltage
ON	ON	ON	Self-test (approx. 1 s)
ON	OFF	OFF	Ready for operation No active WLAN connection
ON	Flashing	ON	Communication active
ON	OFF	Blinking	Client Mode Waiting for connection
Blinking	OFF	OFF	Trouble

The Lenze Smart Keypad app can be found in the Google Play Store or in the Apple App Store.

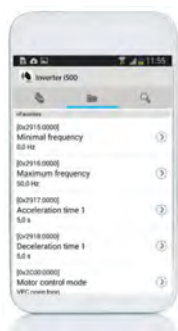

Android



iOS

Additional conformities and approvals		
CE	RED	EN 301489-1 V2.1.1:2016
		EN 301489-17 V3.1.1:2016
		EN 300328 V2.1.1:2016
FCC	Part 15.107/15.109 ICES-003	

Connection data (default setting)	
IP address	192.168.178.1
SSID	<Product type>_<10-digit identifier>
Password	password

WLAN module	
Order code	Type
I5MADW00000005	Range in open space: 100 m, conditions on site may restrict the range.



Blanking cover

Protection and optics

The blanking cover protects the terminals and provides for uniform optics if no other module is plugged on.



Blanking cover		
Order code	Type	VPE
		Piece
I5ZAA0000M	Protection against dust Uniform optics	4

Setpoint potentiometer

For the external selection of an analog setpoint.

The setpoint selection (e.g. motor speed) can be manually set via the external potentiometer.

The setpoint potentiometer is connected to the analog input terminals of the inverter.

The position is displayed on the scale via the rotary knob.

The components have to be ordered separately.



Setpoint potentiometer		
Order code	Name	Type
ERPD0010K0001W	Potentiometer	10 k Ω /1 W
ERZ0001	Rotary knob	Diameter 36 mm
ERZ0002	Scale	Scale 0 ... 100 %, Diameter 62 mm

Memory modules

For serial commissioning, Lenze offers its customers multipacked, unwritten memory modules (EPM). Together with the EPM copier, the EPMs can be duplicated at any place.

A memory module is included in the scope of supply of the inverter.



Memory module		
Order code	Type	VPE
		Piece
I0MAPA0000000M	Easily pluggable Duplicate data set with memory module copier	12

Accessories

Mains chokes



Memory module copier

For duplicating data on memory modules for a faster standard set-up.

The memory module copier is a copying system for all memory modules from Lenze. With the help of simple optical user guidance, the data of a module is copied quickly and reliably to another memory module.



Memory module copier	
Order code	Type
EZAEDE1001	Data set copier for memory modules

Mains chokes

Mains chokes reduce the effects of the inverter on the supplying mains.

The switching operations in the inverter cause high-frequency interferences that will be transmitted unfiltered to the supplying mains. Mains chokes smooth the steep and pulse-like curves coming from the Inverter and make them more sinusoidal. Moreover, the effective mains current is reduced and thus energy is saved.

Mains chokes can be used without restrictions in conjunction with RFI filters.

Please note that the use of a mains choke reduces the mains voltage at the input of the inverter. The typical voltage drop across the mains choke is around 4 % at its rated point.



The matching assignment of these accessories is specified in the technical data of the devices.



RFI filters / Mains filters

RFI and mains filters are used to ensure compliance with the EMC requirements of European Standard EN 61800-3. This standard defines the EMC requirements for electrical drive systems in various categories.

- RFI filters are capacitive accessory components. RFI filters reduce conducted noise emissions. RFI filters are also called EMC filters.
- Mains filters are a combination of mains choke and RFI filter. Mains filters reduce the conducted noise emission.

Definition of the environments

(EN 61800-3)

First environment

The first environment comprises residential buildings or locations that are directly connected to a low-voltage system for supplying residential areas.

Second environment

The second environment comprises facilities or locations that are not directly connected to a low-voltage system for supplying residential areas.

Category C1

Category C1 defines the requirements for drive systems that are intended for the use in the first environment at a rated voltage lower than 1000 V.

The limit values of the EN 61800-3 comply with EN 55011 class B.

Category C2

Category C2 defines the requirements for permanently installed fixed drive systems that are intended for the use in the first environment at a rated voltage lower than 1000 V. Installation and commissioning may only be carried out by specialist personnel with EMC knowledge.

The limit values of the EN 61800-3 comply with EN 55011 class A group 1.

Category C3

Category C3 defines the requirements for drive systems that are exclusively intended for the use in the second environment at a rated voltage lower than 1000 V.

The limit values of the EN 61800-3 comply with EN 55011 class A group 2.



When working with stricter line-bound noise emission requirements which cannot be met using the radio interference suppression measures integrated in the inverter, external filters can be used. The filters can be installed below or next to the inverter.

If necessary, the internal filters have to be deactivated when external filters are used. For this purpose, remove the IT screws of the inverters.

Accessories

Brake switches



Comparison of integrated and external RFI filters

RFI filters	Filter types			
	Integrated in the inverter	External		
		Low Leakage	Short Distance	Long Distance
Use	In standard applications	In mobile systems	With short cable length	At switching frequencies 4 kHz and 8 kHz.
Optimisation	Easy use	For low leakage current	For low leakage current	For long motor cable
Reduces noise emissions	Cable-guided and radiated	Cable-guided	Cable-guided	Cable-guided



The matching assignment of these accessories is specified in the technical data of the devices.

Sine filter

A sinusoidal filter in the motor cable limits the rate of voltage rise and the capacitive charge/discharge currents between the conductors that occur during inverter operation.



Only use a sinusoidal filter with standard asynchronous motors 0 to 550 V.

Operation only with V/f or square-law V/f characteristic control.

Set the switching frequency permanently to the specified value.

Limit the output frequency of the inverter to the given value.



The matching assignment of these accessories is specified in the technical data of the devices.

Brake switches

For switching an electromechanical brake.

The brake switch consists of a rectifier and an electronic circuit breaker.

It is mounted on the control cabinet plate. Control is performed using a digital output on the inverter.



Brake switches		Half-wave rectifiers	Bridge rectifiers
Order code		E82ZWBRE	E82ZWBRB
Input voltage	V	AC 320 - 550	AC 180 - 317
Output voltage	V	DC 180 (with AC 400) DC 225 (with AC 500)	DC 205 (with AC 230)
Max. brake current	A	0.61	0.54



Mounting

Shield mounting kit

Motor cable

If the shielding of the motor cable is centrally connected to an earthing busbar in the control cabinet, no shielding is required.

For a direct connection of the shielding of the motor cable to the inverter, the optionally available accessories can be used consisting of shield sheet and fixing clips or wire clamps.



Inverter	Shield mounting kit			
	Order code	VPE Piece		
i510-C0.25/230-1	EZAMBHXM014/S	1x motor shield sheet 2x fixing clips		
i510-C0.25/230-2				
i510-C0.37/230-1				
i510-C0.37/230-2				
i510-C0.55/230-1				
i510-C0.55/230-2				
i510-C0.75/230-1				
i510-C0.75/230-2				
i510-C1.1/230-1				
i510-C1.1/230-2				
i510-C1.5/230-1				
i510-C1.5/230-2				
i510-C2.2/230-1			EZAMBHXM014/M	5x motor shield sheet 10x fixing clips
i510-C2.2/230-2				
i510-C0.37/400-3				
i510-C0.55/400-3				
i510-C0.75/400-3				
i510-C1.1/400-3				
i510-C1.5/400-3				
i510-C2.2/400-3				
i510-C3.0/400-3	EZAMBHXM015/S	1x motor shield sheet 1x fixing clips 1x wire clamp (cable diameter 4 ... 15 mm)		
i510-C4.0/400-3				
i510-C5.5/400-3	EZAMBHXM015/M	5x motor shield sheet 5x fixing clips 5x wire clamp (cable diameter 4 ... 15 mm)		
i510-C7.5/400-3	EZAMBHXM016/S	1x motor shield sheet 1x fixing clips 1x wire clamp (cable diameter 10 ... 20 mm)		
i510-C11/400-3				

Accessories

Mounting
Terminal strips



Terminal strips

For connecting the inverter, the connections are equipped with pluggable terminal strips. Pluggable terminal strips are available separately for service purposes or if cable harnesses need to be physically separated.

Inverter	Terminal strips Mains connection X100		Terminal strips Motor connection X105	
	Order code	VPE	Order code	VPE
		Piece		Piece
i510-C0.25/230-1	EZA EVE032/M	10	EZA EVE038/M	10
i510-C0.37/230-1				
i510-C0.55/230-1				
i510-C0.75/230-1				
i510-C1.1/230-1	EZA EVE033/M			
i510-C1.5/230-1				
i510-C2.2/230-1				
i510-C0.25/230-2	EZA EVE034/M	10		
i510-C0.37/230-2				
i510-C0.55/230-2				
i510-C0.75/230-2				
i510-C1.1/230-2	EZA EVE035/M			
i510-C1.5/230-2				
i510-C2.2/230-2				
i510-C0.37/400-3	EZA EVE036/M	10		
i510-C0.55/400-3				
i510-C0.75/400-3				
i510-C1.1/400-3				
i510-C1.5/400-3				
i510-C2.2/400-3				

Terminal strips	Order code	VPE	Terminal strips	Order code	VPE
		Piece			Piece
Relay X9	EZA EVE030/M	10	CANopen / Modbus X216	EZA EVE042/M	10



Purchase order

Notes on ordering

The inverters are supplied as complete devices. A control unit with basic I/O is integrated.

As the control unit cannot be extended, the inverter i510 is available in two versions:

- With CANopen/Modbus, switchable.
- Without network.

Purchase order

Order code



Order code

Delivery as complete inverter

Order data: Order code of the complete device.

Order example

Description of the component	Order code
Complete inverter	i51AE175F10010001S
3-phase mains connection 400 V	
Power 0.75 kW (i510-C0.75/400-3)	
Without safety engineering (not available for i510)	
Default setting of parameters: EU region (50-Hz systems)	
Basic I/O with CANopen/Modbus	

"Heavy Duty" Inverter i510

Performance		Inverter	Order code	
kW	HP			
1-phase mains connection 230/240 V, EMC filter integrated				
0.25	0.33	i510-C0.25/230-1	i51AE125B1	OV1
0.37	0.5	i510-C0.37/230-1	i51AE137B1	
0.55	0.75	i510-C0.55/230-1	i51AE155B1	
0.75	1	i510-C0.75/230-1	i51AE175B1	
1.1	1.5	i510-C1.1/230-1	i51AE211B1	
1.5	2	i510-C1.5/230-1	i51AE215B1	
2.2	3	i510-C2.2/230-1	i51AE222B1	
1/3-phase mains connection 230/240 V, EMC filter not integrated				
0.25	0.33	i510-C0.25/230-2	i51AE125D1	OV0
0.37	0.5	i510-C0.37/230-2	i51AE137D1	
0.55	0.75	i510-C0.55/230-2	i51AE155D1	
0.75	1	i510-C0.75/230-2	i51AE175D1	
1.1	1.5	i510-C1.1/230-2	i51AE211D1	
1.5	2	i510-C1.5/230-2	i51AE215D1	
2.2	3	i510-C2.2/230-2	i51AE222D1	
4	5.5	i510-C4.0/230-3	i51AE240C1	
5.5	7.5	i510-C5.5//230-3	i51AE255C1	
3-phase mains connection 400/480 V, EMC filter integrated				
0.37	0.5	i510-C0.37/400-3	i51AE137F1	OV1
0.55	0.75	i510-C0.55/400-3	i51AE155F1	
0.75	1	i510-C0.75/400-3	i51AE175F1	
1.1	1.5	i510-C1.1/400-3	i51AE211F1	
1.5	2	i510-C1.5/400-3	i51AE215F1	
2.2	3	i510-C2.2/400-3	i51AE222F1	
3	4	i510-C3.0/400-3	i51AE230F1	
4	5.5	i510-C4.0/400-3	i51AE240F1	
5.5	7.5	i510-C5.5/400-3	i51AE255F1	
7.5	10	i510-C7.5/400-3	i51AE275F1	
11	15	i510-C11/400-3	i51AE311F1	
Delivery status				
Default setting of parameters: EU region (50-Hz systems)				0
Default setting of parameters: US region (60-Hz systems)				1
Control unit type				
Basic I/O without network				000S
Basic I/O with CANopen/Modbus				001S



Appendix

UL fuses (High SCCR)

Standard Short Circuit Current Ratings (SCCR) and Branch Circuit Protection (BCP) Combinations (Tested per UL61800-5-1, reference UL file E132659)

Max. SCCR values can be reached with standard protection devices without special restrictions.

Inverter			Standard fuses (UL248)			Circuit breaker (UL489)		
Mains	kW	hp	SCCR	Max. rated current	Class	SCCR	Max. rated current	
120 V, 1-ph	0.25	0.33	5 kA	15 A	CC	5 kA	15 A	
120 V, 1-ph	0.37	0.50	5 kA	15 A	CC	5 kA	15 A	
120 V, 1-ph	0.75	1.00	5 kA	30 A	CC, J, T	5 kA	30 A	
120 V, 1-ph	1.10	1.50	5 kA	30 A	CC, J, T	5 kA	30 A	
230 V, 1-ph	0.25	0.33	65 kA	15 A	CC	5 kA	15 A	
230 V, 1-ph	0.37	0.50	65 kA	15 A	CC	5 kA	15 A	
230 V, 1-ph	0.55	0.75	65 kA	15 A	CC	5 kA	15 A	
230 V, 1-ph	0.75	1.00	65 kA	15 A	CC	5 kA	15 A	
230 V, 1-ph	1.10	1.50	65 kA	30 A	CC, J, T	5 kA	30 A	
230 V, 1-ph	1.50	2.00	65 kA	30 A	CC, J, T	5 kA	30 A	
230 V, 1-ph	2.20	3.00	65 kA	30 A	CC, J, T	5 kA	30 A	
230 V, 1/3-ph	0.25	0.33	65 kA	15 A	CC	5 kA	15 A	
230 V, 1/3-ph	0.37	0.50	65 kA	15 A	CC	5 kA	15 A	
230 V, 1/3-ph	0.55	0.75	65 kA	15 A	CC	5 kA	15 A	
230 V, 1/3-ph	0.75	1.00	65 kA	15 A	CC	5 kA	15 A	
230 V, 1/3-ph	1.10	1.50	65 kA	30 A	CC, J, T	5 kA	30 A	
230 V, 1/3-ph	1.50	2.00	65 kA	30 A	CC, J, T	5 kA	30 A	
230 V, 1/3-ph	2.20	3.00	65 kA	30 A	CC, J, T	5 kA	30 A	
230 V, 3-ph	4.00	5.00	100 kA	40 A	J, T	5 kA	40 A	
230 V, 3-ph	5.50	7.50	100 kA	40 A	J, T	5 kA	40 A	
480 V, 3-ph	0.37	0.50	65 kA	15 A	CC	5 kA	15 A	
480 V, 3-ph	0.55	0.75	65 kA	15 A	CC	5 kA	15 A	
480 V, 3-ph	0.75	1.00	65 kA	15 A	CC	5 kA	15 A	
480 V, 3-ph	1.1	1.5	65 kA	15 A	CC	5 kA	15 A	
480 V, 3-ph	1.5	2.0	65 kA	15 A	CC	5 kA	15 A	
480 V, 3-ph	2.2	3.0	65 kA	15 A	CC	5 kA	15 A	
480 V, 3-ph	3.0	4.0	65 kA	25 A	CC, J, T	5 kA	25 A	
480 V, 3-ph	4.0	5.0	65 kA	25 A	CC, J, T	5 kA	25 A	
480 V, 3-ph	5.5	7.5	65 kA	25 A	CC, J, T	5 kA	25 A	
480 V, 3-ph	7.5	10.0	65 kA	40 A	J, T	5 kA	35 A	
480 V, 3-ph	11.0	15.0	65 kA	40 A	J, T	5 kA	35 A	
480 V, 3-ph	15.0	20.0	100 kA	70 A	J, T	See the following page for ratings / restriction for these inverters.		
480 V, 3-ph	18.5	25.0	100 kA	70 A	J, T			
480 V, 3-ph	22	30	100 kA	70 A	J, T			
480 V, 3-ph *	30	40	22 kA	125 A	J, T			
480 V, 3-ph *	37	50	22 kA	125 A	J, T			
480 V, 3-ph *	45	60	22 kA	125 A	J, T			
480 V, 3-ph *	55	75	22 kA	200 A	J, T			
480 V, 3-ph *	75	100	22 kA	200 A	J, T			
480 V, 3-ph *	90	125	22 kA	300 A	J, T		10 kA	300 A
480 V, 3-ph *	110	150	22 kA	300 A	J, T		10 kA	300 A

* Mains choke required



High Short Circuit Current Ratings (SCCR) and Branch Circuit Protection (BCP) Combinations (Tested per UL61800-5-1, reference UL file E132659)

If higher SCCR values are required for the application, specific semiconductor fuses or minimum cabinet space for circuit breakers are to be used.

Inverter			Alternate fuse (semiconductor)		Circuit breaker (UL489)		
Mains	kW	hp	SCCR	Fuse type	SCCR	Max. rated current	Min. cabinet dimensions
120 V, 1-ph	0.25	0.33					
120 V, 1-ph	0.37	0.50					
120 V, 1-ph	0.75	1.00					
120 V, 1-ph	1.10	1.50					
				n/a		n/a	n/a
230 V, 1-ph	0.25	0.33	100 kA	Mersen A60Q15-2	65 kA	15 A	0.042 m ³ 1.48 ft ³
230 V, 1-ph	0.37	0.50	100 kA	Mersen A60Q15-2	65 kA	15 A	
230 V, 1-ph	0.55	0.75	100 kA	Mersen A70QS25-14F	65 kA	15 A	
230 V, 1-ph	0.75	1.00	100 kA	Mersen A70QS25-14F	65 kA	15 A	
230 V, 1-ph	1.10	1.50	100 kA	Mersen A70QS40-14F	65 kA	30 A	
230 V, 1-ph	1.50	2.00	100 kA	Mersen A70QS40-14F	65 kA	30 A	
230 V, 1-ph	2.20	3.00	100 kA	Mersen A70QS40-14F	65 kA	30 A	
230 V, 1/3-ph	0.25	0.33	100 kA	Mersen A60Q15-2	65 kA	15 A	0.042 m ³ 1.48 ft ³
230 V, 1/3-ph	0.37	0.50	100 kA	Mersen A60Q15-2	65 kA	15 A	
230 V, 1/3-ph	0.55	0.75	100 kA	Mersen A70QS25-14F	65 kA	15 A	
230 V, 1/3-ph	0.75	1.00	100 kA	Mersen A70QS25-14F	65 kA	15 A	
230 V, 1/3-ph	1.10	1.50	100 kA	Mersen A70QS40-14F	65 kA	30 A	
230 V, 1/3-ph	1.50	2.00	100 kA	Mersen A70QS40-14F	65 kA	30 A	
230 V, 1/3-ph	2.20	3.00	100 kA	Mersen A70QS40-14F	65 kA	30 A	
230 V, 3-ph	4.00	5.00	100 kA	Mersen A70QS50-22F	65 kA	40 A	0.042 m ³ 1.48 ft ³
230 V, 3-ph	5.50	7.50	100 kA	Mersen A70QS50-22F	65 kA	40 A	
480 V, 3-ph	0.37	0.50	100 kA	Mersen A70QS6-14F	65 kA	15 A	0.042 m ³ 1.48 ft ³
480 V, 3-ph	0.55	0.75	100 kA	Mersen A70QS25-14F	65 kA	15 A	
480 V, 3-ph	0.75	1.00	100 kA	Mersen A70QS25-14F	65 kA	15 A	
480 V, 3-ph	1.1	1.5	100 kA	Mersen A60Q15-2	65 kA	15 A	
480 V, 3-ph	1.5	2.0	100 kA	Mersen A60Q15-2	65 kA	15 A	
480 V, 3-ph	2.2	3.0	100 kA	Mersen A60Q15-2	65 kA	15 A	
480 V, 3-ph	3.0	4.0	100 kA	Mersen A70QS40-14F	65 kA	25 A	0.042 m ³ 1.48 ft ³
480 V, 3-ph	4.0	5.0	100 kA	Mersen A70QS40-14F	65 kA	25 A	
480 V, 3-ph	5.5	7.5	100 kA	Mersen A70QS40-14F	65 kA	25 A	
480 V, 3-ph	7.5	10.0	100 kA	Mersen A70QS50-22F	65 kA	40 A	0.17 m ³ 6 ft ³
480 V, 3-ph	11.0	15.0	100 kA	Mersen A70QS50-22F	65 kA	40 A	
480 V, 3-ph	15.0	20.0	100 kA	Mersen A70QS80-22F	65 kA	60 A	0.57 m ³ 20 ft ³
480 V, 3-ph	18.5	25.0	100 kA	Mersen A70QS80-22F	65 kA	60 A	
480 V, 3-ph	22	30	100 kA	Mersen A70QS80-22F	65 kA	60 A	
480 V, 3-ph *	30	40	100 kA	Mersen A70QS80-4	35 kA	125 A	
480 V, 3-ph *	37	50	100 kA	Mersen A70QS100-4	35 kA	125 A	
480 V, 3-ph *	45	60	100 kA	Mersen A70QS125-4	35 kA	125 A	
480 V, 3-ph *	55	75	100 kA	Mersen A70QS200-4	35 kA	200 A	In Preparation
480 V, 3-ph *	75	100	100 kA	Mersen A70QS200-4	35 kA	200 A	
480 V, 3-ph *	90	125	100 kA	Eaton FWP-350A Mersen A70QS350-4	In Preparation		
480 V, 3-ph *	110	150	100 kA	Eaton FWP-350A Mersen A70QS350-4	In Preparation		

* Mains choke required



Good to know

Approvals/directives

CCC	China Compulsory Certification documents the compliance with the legal product safety requirements of the PR of China - in accordance with Guobiao standards.
c _{CSA} _{US}	CSA certificate, tested according to US and Canada standards
UE	Union Européenne documents the declaration of the manufacturer that EU Directives are complied with.
CEL	China Energy Label documents the compliance with the legal energy efficiency requirements for motors, tested according to the PR of China and Guobiao standards
CSA	CSA Group (Canadian Standards Association) CSA certificate, tested according to Canada standards
UL ^{Energy} _{US CA}	Energy Verified Certificate Determining the energy efficiency according to CSA C390 for products within the scope of energy efficiency requirements in the USA and Canada
c _{UL} _{US}	UL certificate for products, tested according to US and Canada standards
c _{UR} _{US}	UL certificate for components, tested according to US and Canada standards
EAC	Customs union Russia / Belarus / Kazakhstan certificate documents the declaration of the manufacturer that the specifications for the Eurasian conformity (EAC) required for placing electronic and electromechanical products on the market of the entire territory of the Customs Union (Russia, Belarus, Kazakhstan, Armenia and Kyrgyzstan) are complied with.
UL	Underwriters Laboratory Listed Product
UL _{LISTED}	UL Listing approval mark as proof that the product has been tested and the applicable safety requirements have been confirmed by UL (Underwriters Laboratory).
UR	UL Recognized Component approval mark as proof that the UL approved component can be used in a product or system bearing the UL Listing approval mark.



Operating modes of the motor

Operating modes S1 ... S10 as specified by EN 60034-1 describe the basic stress of an electrical machine.

In continuous operation a motor reaches its permissible temperature limit if it outputs the rated power dimensioned for continuous operation. However, if the motor is only subjected to load for a short time, the power output by the motor may be greater without the motor reaching its permissible temperature limit. This behaviour is referred to as overload capacity.

Depending on the duration of the load and the resulting temperature rise, the required motor can be selected reduced by the overload capacity.

The most important operating modes

S1, continuous operation	S2, short-term operation
<p>Operation with a constant load until the motor reaches the thermal steady state. The motor may be actuated continuously with its rated power.</p>	<p>Operation with a constant load, but the motor does not reach the thermal steady state. During the following standstill, the motor winding cools down to the ambient temperature again. The increase in power depends on the loading duration.</p>
Intermittent operation S3	Non-intermittent periodic operation S6
<p>Sequence of identical load cycles including operation with constant load and subsequent standstill. Start-up and braking processes do not have any influence on the winding temperature. The steady state is not reached. The guide values apply to a cycle duration of 10 minutes. The increase in power depends on the cycle duration and the ratio of load time to standstill time.</p>	<p>Sequence of identical load cycles including operation with constant load and subsequent no-load operation. The motor cools down during the no-load phase. Start-up and braking processes do not have any influence on the winding temperature. The steady state is not reached. The guide values apply to a cycle duration of 10 minutes. The increase in power depends on the cycle duration and the ratio of load time to idle time.</p>

P Power
 t Time
 t_L Idle time
 ϑ Temperature

P_V Power loss
 t_B Load period
 t_S Cycle duration



Motor control types

The inverter provides various motor control types.

Linear V/f characteristic control

The output voltage is increased proportionately to the output frequency.

In case of low output frequencies, the motor voltage can be increased to ensure a minimum current for the breakaway torque. In the field weakening range, the output voltage of the inverter is constant (mains voltage) and the frequency can be further increased depending on the load. The maximum torque of the motor is reduced proportionately to the square of the frequency increase, the maximum output power of the motor being constant.

Application areas are for instance: Single drives with constant load.

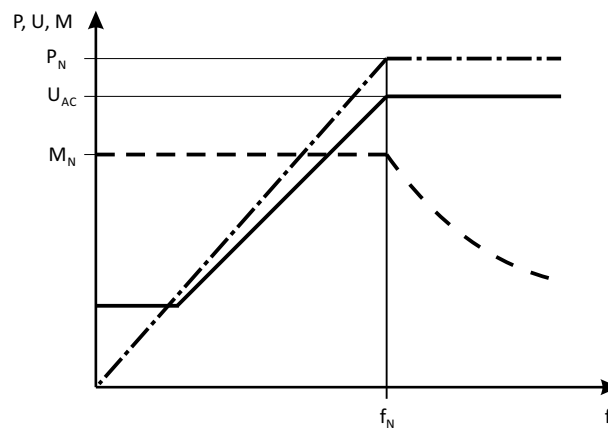

P	Power	M_{rated}	Rated torque
V	Voltage	f_{rated}	Rated frequency
M	Torque	M_{rated}	Rated torque
f	Frequency	f_{rated}	Rated frequency

Square-law V/f characteristic control

The output voltage is increased squarely to the output frequency.

In case of low output frequencies, the motor voltage can be increased to ensure a minimum current for the breakaway torque. In the field weakening range, the output voltage of the inverter is constant (mains voltage) and the frequency can be further increased depending on the load. The maximum torque of the motor is reduced squarely to the frequency increase, the maximum output power of the motor being constant.

Application areas are for instance:

- Pumps
- Fans
- Ventilators

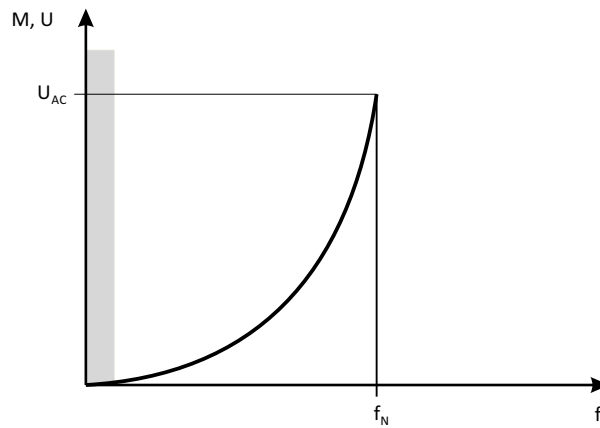

V	Voltage	U_{AC}	Mains voltage
f	Frequency	f_{rated}	Rated frequency
M	Torque		

VFCeco

The VFCeco mode has a special effect in the partial load operational range. Usually, three-phase AC motors are supplied there with a higher magnetising current than required by the operating conditions. The VFCeco mode reduces the losses in the partial load operational range so that savings up to 30 % are possible.

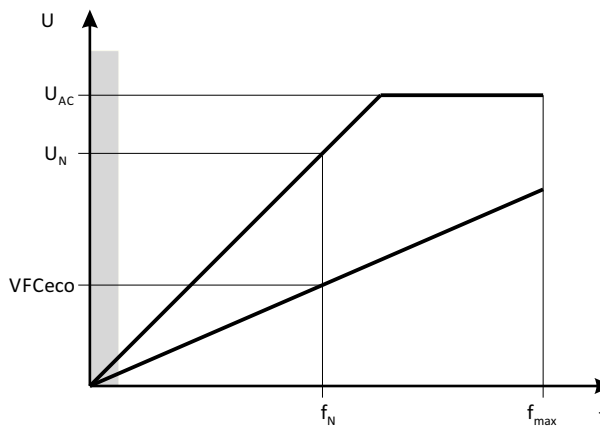

V	Voltage	f	Frequency
U_{AC}	Mains voltage	f_{rated}	Rated frequency
U_{rated}	Rated voltage	f_{max}	Max. frequency

Sensorless vector control (SLVC)

In vector control, an inverted voltage model is used for calculation. The parameters are detected via a parameter identification. The inverter determines the angle between current and voltage. This imposes a current on the motor".

Compared to the V/f characteristic control, the vector control serves to achieve improved drive characteristics thanks to:

- higher torque throughout the entire speed range
- higher speed accuracy and higher concentricity factor
- higher efficiency

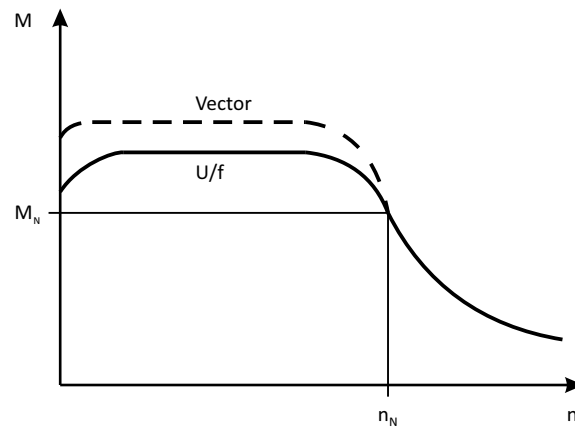

M Torque
n Speed

M_{rated} Rated torque
 n_{rated} Rated speed

Application areas are for instance:

- Single drives with changing loads
- Single drives with high starting duty
- Sensorless speed control of three-phase AC motors

Switching frequencies

On an inverter, the term "switching frequency" is understood to mean the frequency with which the input and outputs of the output module (inverter) are switched. On an inverter, the switching frequency can generally be set to values between 2 and 16 kHz, whereby the selection is based on the respective power output

As switching the modules cause heat losses, the inverter can provide higher output currents at low switching frequencies than at high frequencies. Additionally, it is distinguished between the operation at a permanently set switching frequency and a variably set switching frequency. Here, the switching frequency is automatically reduced as a function of the device utilisation.

At a higher switching frequency, the noise generation is less.

Features	Versions
Switching frequencies	<ul style="list-style-type: none"> • 2 kHz • 4 kHz • 8 kHz • 16 kHz • variable (automatic adjustment)

Appendix

Good to know
Enclosures



Enclosures

The degree of protection indicates the suitability of a motor for specific ambient conditions with regard to humidity as well as the protection against contact and the ingress of foreign particles. The degrees of protection are classified by EN 60529.

The first code number after the code letters IP indicates the protection against the ingress of foreign particles and dust. The second code number refers to the protection against the ingress of humidity.

Code number 1	Degree of protection	Code number 2	Degree of protection
0	No protection	0	No protection
1	Protection against the ingress of foreign particles $d > 50$ mm. No protection in case of deliberate access.	1	Protection against vertically dripping water (dripping water).
2	Protection against medium-sized foreign particles, $d > 12$ mm, keeping away fingers or the like.	2	Protection against diagonally falling water (dripping water), 15° compared to normal service position.
3	Protection against small foreign particles $d > 2.5$ mm. Keeping away tools, wires or the like.	3	Protection against spraying water, up to 60° from vertical.
4	Protection against granular foreign particles, $d > 1$ mm, keeping away tools, wire or the like.	4	Protection against spraying water from all directions.
5	Protection against dust deposits (dust-protected), complete protection against contact.	5	Protection against water jets from all directions.
6	Protection against the ingress of dust (dust-proof), complete protection against contact.	6	Protection against choppy seas or heavy water jets (flood protection).

🏢 Lenze Drives GmbH
Postfach 10 13 52, D-31763 Hameln
Breslauer Straße 3, D-32699 Extertal
Germany
HR Lemgo B 6478
☎ +49 5154 82-0
📠 +49 5154 82-2800
@ sales.de@lenze.com
🌐 www.lenze.com

✂ Lenze Service GmbH
Breslauer Straße 3, D-32699 Extertal
Germany
☎ 0080002446877 (24 h Helpline)
📠 +49 5154 82-1112
@ service.de@lenze.com

