

Multifunctional time delay relay

MFT IQ13S



MFT IQ13S

- **4 functions**
- **Zoomvoltage:
24 ... 240 Vac/dc**
- **1 output contact**

Function

Q 4-functions

- E** Delay on
- A** Delay off
- I1** Pulse limitation timer voltage control
- B2** Cycling timer starting on a pause

Time ranges

Adjustable 0,05 s ... 100 h

Output relay

1 changer potential free 250 Vac / 8 A

Indicators

- Green LED ON: indication of supply voltage
- Green LED flashes: indication of time
- Yellow LED ON/OFF: indication of relay output

Supply voltage

24 ... 240 Vac/dc -15% +10%

AC 48 ... 63 Hz, 100% duration of operation

Reference data

Selectron® MFT	Article no.
MFT IQ13S	41130001
(Order data see chapter 1)	

Multifunction time delay relay

MFT IQ13S

Technical data	
Input circuit	MFT IQ13S
24 ... 240 Vac/dc	4 VA / 1,5 W
Residual ripple for dc	10%
Drop-out voltage	>30% of minimum rated supply voltage
Control contact / Voltage controlled	
Parallel switching of loads possible	
Input not potential free	terminals A1 - B1
Trigger level (sensitivity)	automatic adapted to supply voltage
Max. line length	10 m
Min. control pulse length	DC 50 ms / AC 100 ms
Accuracy	
Base accuracy	±1% of the scale limit
Repeatability of the scale limit	<0,5% or ±5 ms
Adjustment accuracy	<5% of the scale limit
Temperature influence	≤0,01% / °C
Reaction times	
Recovery time	100 ms

Type key

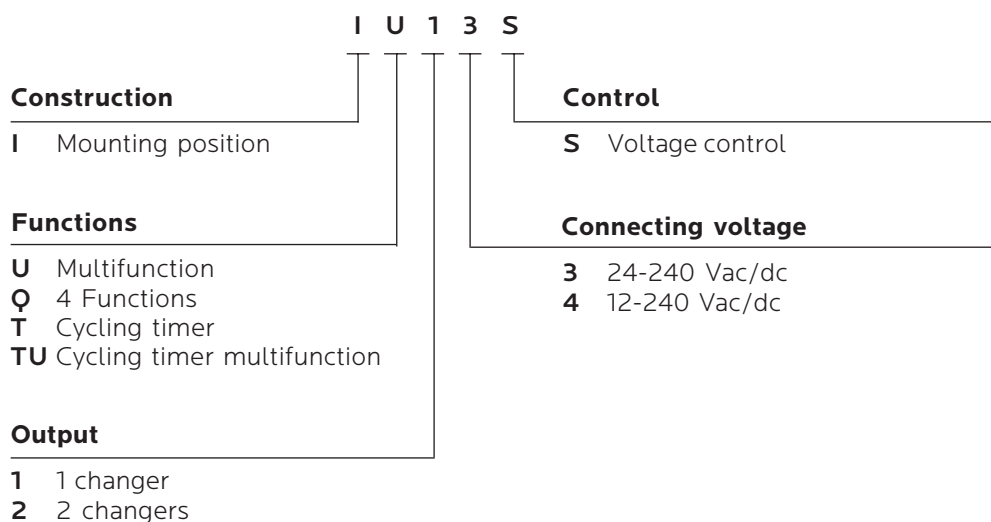

Multifunctional time delay relay

MFT IQ13S

Function descriptions

E - Delay on

When the supply voltage U is applied, the set interval t begins (green LED U/t flashes). After the interval t has expired



(green LED U/t illuminated) the output relay switches into on-position (yellow LED illuminated). This status remains until the supply voltage U is interrupted. If the supply voltage U is interrupted before expiry of the interval t, the interval already expired is erased and is restarted when the supply voltage U is next applied.

A - Delay off

The supply voltage U must be constantly applied to the device (green LED U/t illuminated). When the control contact

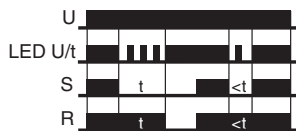

S is closed, the output relay R switches into on-position (yellow LED illuminated). If the control contact S is opened, the set interval t begins (green LED U/t flashes). After the interval t has expired (green LED U/t illuminated) the output relay switches into off-position (yellow LED not illuminated). If the control contact is closed again before the interval t (green LED U/t illuminated) has expired, the interval already expired is erased and is restarted with the next cycle.

I1 - Pulse limitation timer voltage control

When supply voltage U is applied, the output relay R switches into on-position (yellow LED illuminated) and the set interval t



begins (green LED U/t flashes). After the interval t has expired (green LED U/t illuminated) the output relay switches into off-position (yellow LED not illuminated). This status remains until the supply voltage is interrupted. If the supply voltage is interrupted before the interval t has expired, the output relay switches into off-position. The interval already expired is erased and is restarted when the supply voltage is next applied.

B2 - Cycling timer starting on a pause

When the supply voltage U is applied, the set interval t begins (green LED U/t flashes). After the interval t has expired, the



output relay R switches into on-position (yellow LED illuminated) and the set interval t begins again. After the interval t has expired, the output relay switches into off-position (yellow LED not illuminated). The output relay is triggered in the ratio 1:1 until the supply voltage is interrupted.

Multifunctional time delay relay

MFT IQ13S

Connection

MFT IQ13S

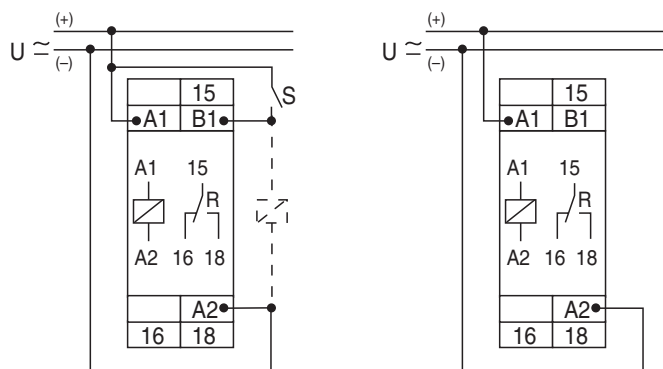

Load limit curves

MFT IQ13S

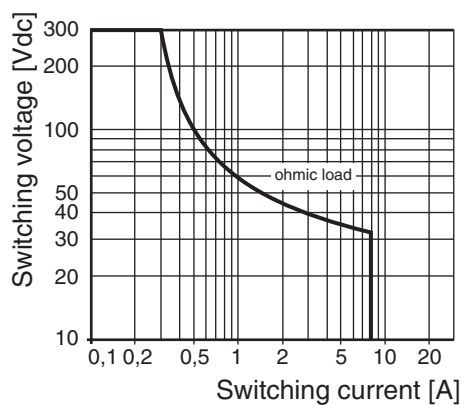

Dimensions

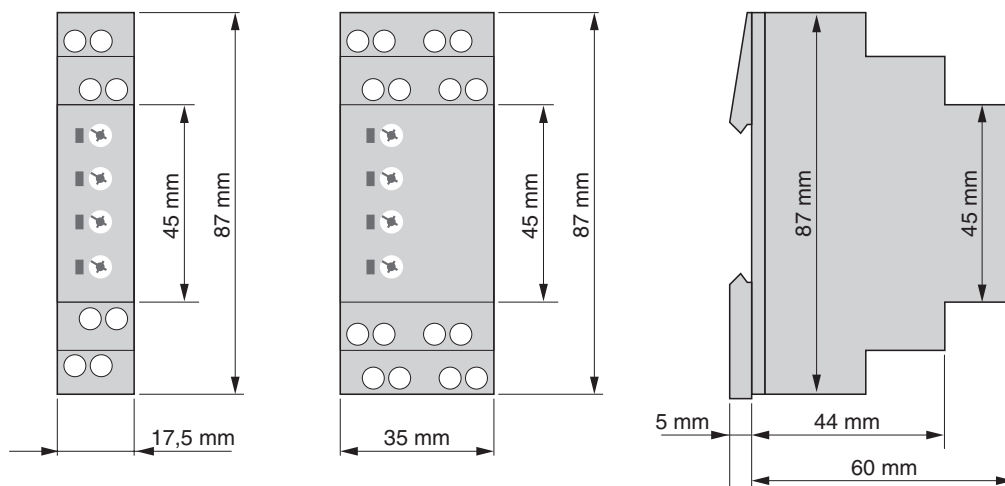

Multifunction time delay relay

MFT IU14S, IU24S



MFT IU14S

- **7 functions**
- **Zoomvoltage:**
12 ... 240 Vac/dc
- **2 output contacts**

Function

U Multifunction

- E** Delay on
- A** Delay off
- I2** Pulse extension with control contact
- W2** Wiping on trailing edge
- E1** Delay on with control contact
- I1** Pulse limitation timer voltage control
- B2** Cycling timer starting on a pause



MFT IU24S

Time ranges

Adjustable 0,05 s ... 100 h

Output relay

1 or 2 changers potential free 250 Vac / 8 A

Indicators

- Green LED ON: indication of supply voltage
- Green LED flashes: indication of time
- Yellow LED ON/OFF: indication of relay output

Supply voltage

12... 240 Vac/dc -10% +10%

AC 48 ... 63 Hz, 100% duration of operation

Reference data

Selectron® MFT	Article no.
MFT IU14S	41130003
MFT IU24S	41130004
(Order data see chapter 1)	

Multifunction time delay relay

MFT IU14S, IU24S

Technical data	
Input circuit	MFT IU143S, IU24S
	12 ... 240 Vac/dc
	IU14S: 4 VA / 1,5 W IU24S: 6 VA / 2 W
	Residual ripple for dc 10%
	Drop-out voltage >30% of minimum rated supply voltage
Control contact / Voltage controlled	
	Parallel switching of loads possible
	Input not potential free terminals A1 - B1
	Trigger level (sensitivity) automatic adapted to supply voltage
	Max. line length 10 m
	Min. control pulse length DC 50 ms / AC 100 ms
Accuracy	
	Base accuracy ±1% of the scale limit
	Repeatability of the scale limit <0,5% or ±5 ms
	Adjustment accuracy <5% of the scale limit
	Temperature influence ≤0,01% / °C
Reaction times	
	Recovery time 100 ms

Type key

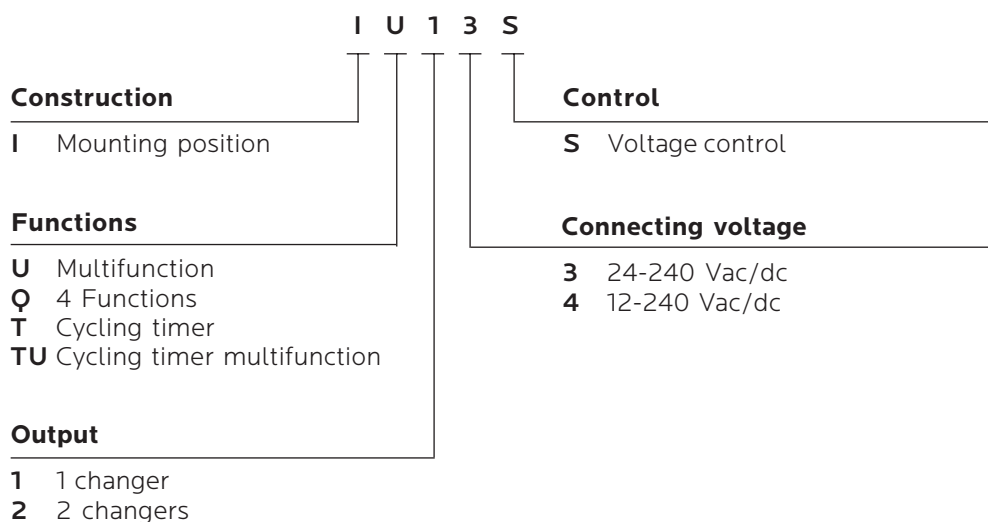

Multifunctional time delay relay

MFT IU14S, IU24S

Function descriptions

E - Delay on

When the supply voltage U is applied, the set interval t begins (green LED U/t flashes). After the interval t has expired



(green LED U/t illuminated) the output relay switches into on-position (yellow LED illuminated). This status remains until the supply voltage U is interrupted. If the supply voltage U is interrupted before expiry of the interval t, the interval already expired is erased and is restarted when the supply voltage U is next applied.

A - Delay off

The supply voltage U must be constantly applied to the device (green LED U/t illuminated). When the control contact

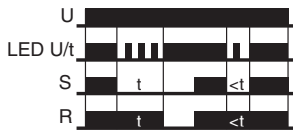

S is closed, the output relay R switches into on-position (yellow LED illuminated). If the control contact S is opened, the set interval t begins (green LED U/t flashes). After the interval t has expired (green LED U/t illuminated) the output relay switches into off-position (yellow LED not illuminated). If the control contact is closed again before the interval t (green LED U/t illuminated) has expired, the interval already expired is erased and is restarted with the next cycle.

I2 - Pulse extension with control contact

The supply voltage U must be constantly applied to the device (green LED U/t illuminated). When the control contact

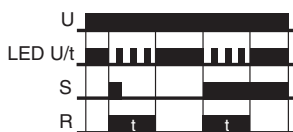

S is closed, the output relay R switches into on-position (yellow LED illuminated) and the set interval t begins (green LED U/t flashes). After the interval t has expired (green LED U/t illuminated) the output relay switches into off-position (yellow LED not illuminated). During the interval, the control contact can be operated any number of times. A further cycle can only be started when the cycle run has been completed.

W2 - Wiping on trailing edge

The supply voltage U must be constantly applied to the device (green LED U/t illuminated). Closing the control

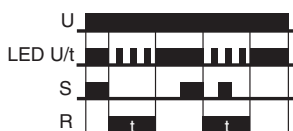

contact S has no influence on the condition of the output relay R. When the control contact is opened, the output relay switches into on-position (yellow LED illuminated) and the set interval t begins (green LED U/t flashes). After the interval t has expired (green LED U/t illuminated), the output relay switches into off-position (yellow LED not illuminated). During the interval, the control contact can be operated any number of times. A further cycle can only be started when a cycle run has been completed.

E1 - Delay on with control contact

The supply voltage U must be constantly applied to the device (green LED U/t illuminated). When the control contact



S is closed, the set interval t begins (green U/tLED flashes). After the interval t has expired (green LED U/t illuminated) the output relay R switches into on-position (yellow LED illuminated). This status remains until the control contact is opened. If the control contact is opened before the interval t has expired, the interval already expired is erased and is restarted with the next cycle.

I1 - Pulse limitation timer voltage control

When supply voltage U is applied, the output relay R switches into on-position (yellow LED illuminated) and the set interval t

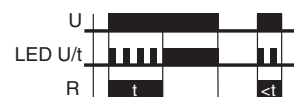

begins (green LED U/t flashes). After the interval t has expired (green LED U/t illuminated) the output relay switches into off-position (yellow LED not illuminated). This status remains until the supply voltage is interrupted. If the supply voltage is interrupted before the interval t has expired, the output relay switches into off-position. The interval t already expired is erased and is restarted when the supply voltage is next applied.

B2 - Cycling timer starting on a pause

When the supply voltage U is applied, the set interval t begins (green LED U/t flashes). After the interval t has expired, the

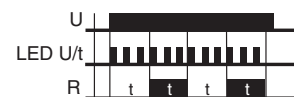

output relay R switches into on-position (yellow LED illuminated) and the set interval t begins again. After the interval t has expired, the output relay switches into off-position (yellow LED not illuminated). The output relay is triggered in the ratio 1:1 until the supply voltage is interrupted.

Multifunctional time delay relay

MFT IU14S, IU24S

Connection

MFT IU14S

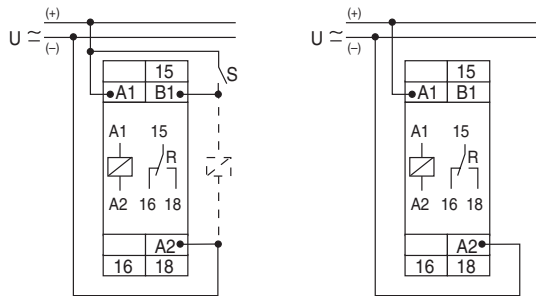

MFT IU24S

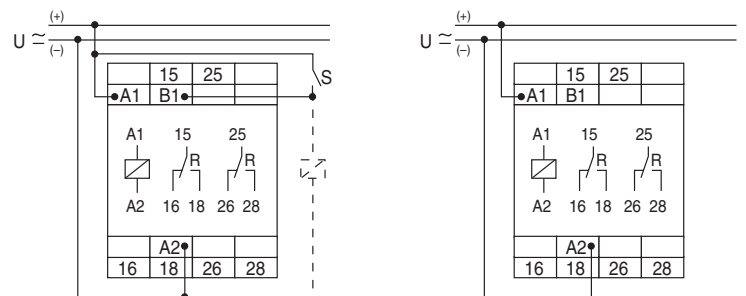

Load limit curves

MFT IU14S

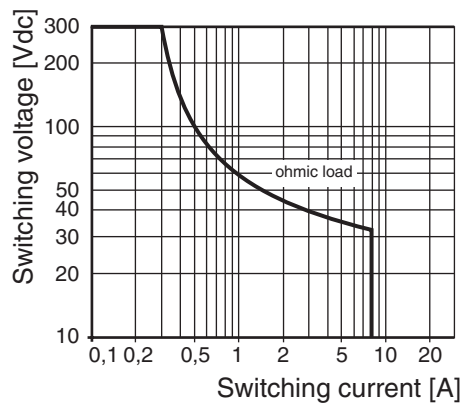

MFT IU24S

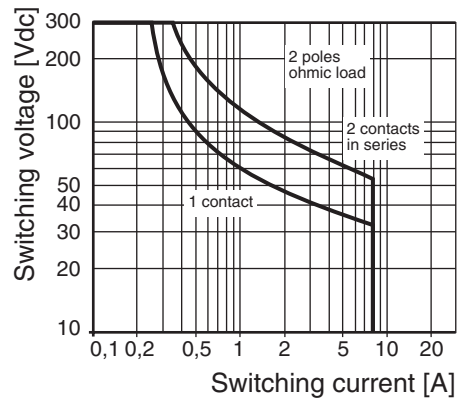

Dimensions

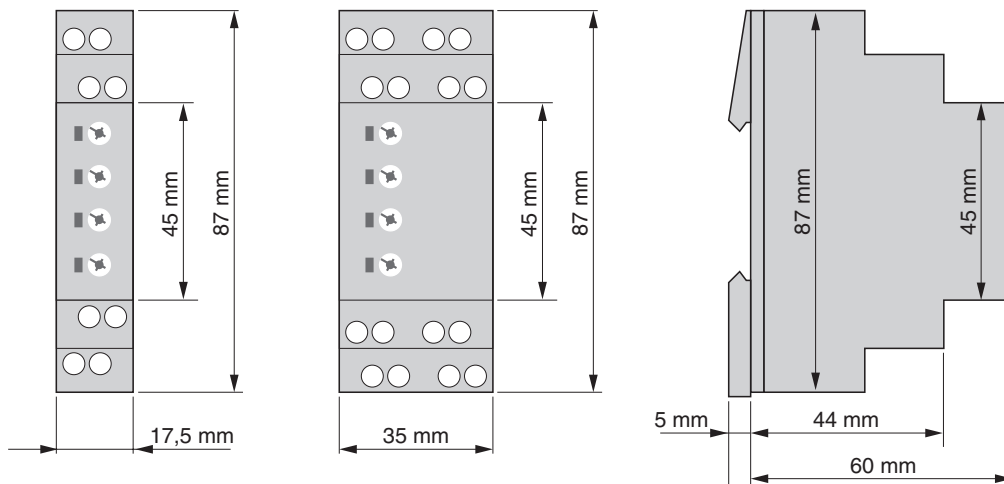

Clock-pulse generator time delay relay

MFT IT14S



MFT IT14S

- **2 functions**
- **Zoomvoltage:**
12 ... 240 Vac/dc
- **1 output contact**

Function

T Cycling timer

TP Cycling timer relay beginning on a pause

TI Cycling timer relay beginning on a pulse

Time ranges

Adjustable 0,05 s ... 100 h

Output relay

1 changer potential free 250 Vac / 8 A

Indicators

Green LED ON: indication of supply voltage

Green LED flashes slowly: indication of time t1

Green LED flashes fast: indication of time t2

Yellow LED ON/OFF: indication of relay output

Supply voltage

12 ... 240 Vac/dc -10% +10%

AC 48 ... 63 Hz, 100% duration of operation

Reference data

Selectron® MFT	Article no.
MFT IT14S	41130007
(Order data see chapter 1)	

Clock-pulse generator time delay relay

MFT IT14S

Technical data	
Input circuit	MFT IT14S
12 ... 240 Vac/dc	4 VA / 1,5 W
Residual ripple for dc	10%
Drop-out voltage	>30% of minimum rated supply voltage
Control contact / Voltage controlled	
Parallel switching of loads possible	
Input not potential free	terminals A1 - B1
Trigger level (sensitivity)	automatic adapted to supply voltage
Max. line length	10 m
Min. control pulse length	DC 50 ms / AC 100 ms
Accuracy	
Base accuracy	±1% of the scale limit
Repeatability of the scale limit	<0,5% or ±5 ms
Adjustment accuracy	<5% of the scale limit
Temperature influence	≤0,01% / °C
Reaction times	
Recovery time	100 ms

Type key

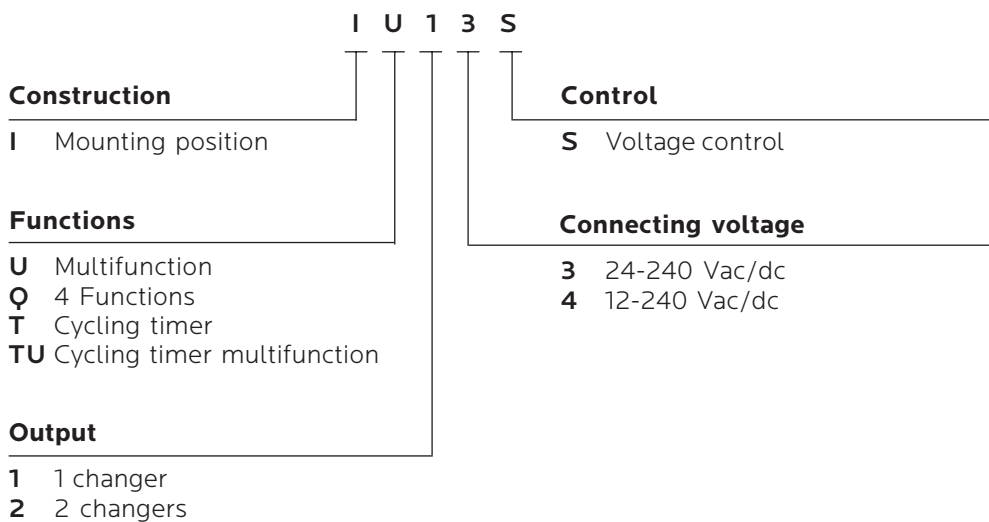

Clock-pulse generator time delay relay

MFT IT14S

Function descriptions

TP - Cycling timer relay beginning on a pause

When the supply voltage U is applied, the set interval t_1 begins (green LED U/t flashes slowly). After the interval t_1 has

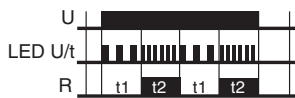

expired, the output relay switches into on-position (yellow LED illuminated) and the set interval t_2 begins (green LED U/t flashes fast). After the interval t_2 has expired, the output relay switches into off-position (yellow LED not illuminated). The output relay is triggered in the ratio of the two set intervals until the supply voltage is interrupted.

TI - Cycling timer relay beginning on a pulse

When the supply voltage is applied, the output relay R switches into on-position (yellow LED illuminated) and the set

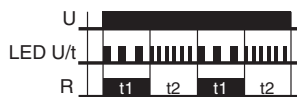

interval t_1 begins (green LED U/t flashes slowly). After the interval t_1 has expired, the output relay switches into off-position (yellow LED not illuminated) and the set interval t_2 begins (green LED U/t flashes fast). After the interval t_2 has expired, the output relay switches into on-position again (yellow LED illuminated). The output relay is triggered in the ratio of the two set intervals until the supply voltage is interrupted.

Clock-pulse generator time delay relay

MFT IT14S

Connection

MFT IT14S

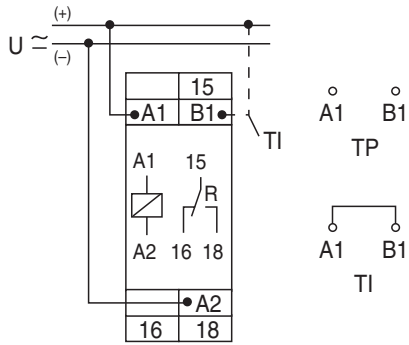

Load limit curves

MFT IT14S

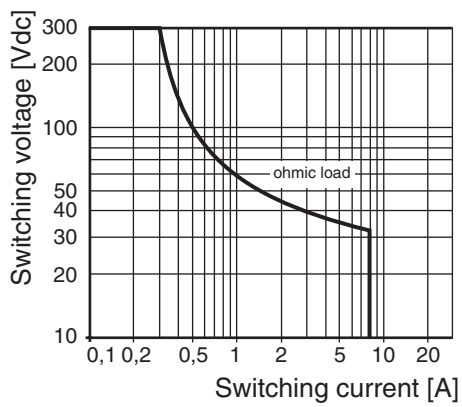

Dimensions

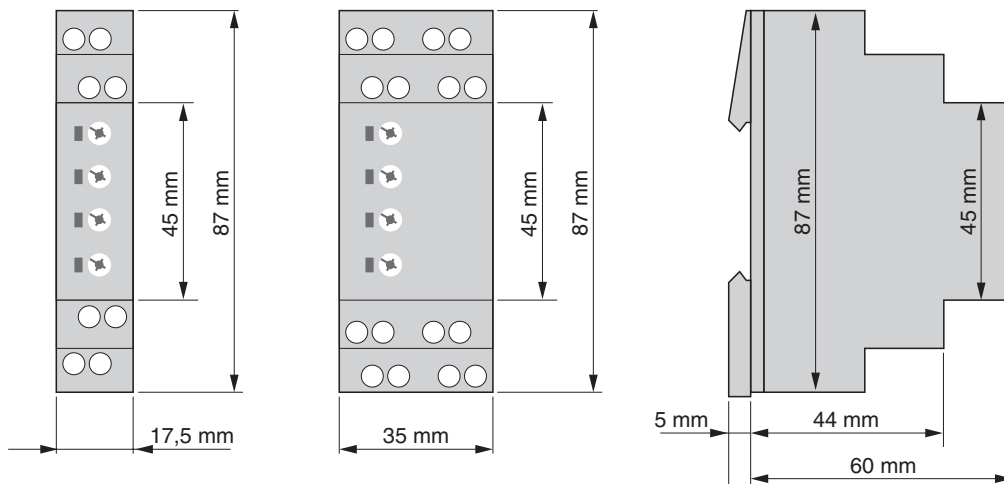

Multifunction clock-pulse generator relay

MFT ITU24S



MFT ITU24S

- **7 functions**
- **Zoomvoltage:**
12 ... 240 Vac/dc
- **2 output contacts**

Function

TU Cycling timer multifunction

- TP** Cycling timer relay beginning on a pause
- TI** Cycling timer relay beginning on a pulse
- EA** Delay on and delay off
- EI1** Input delay pulse limitation timer voltage control
- EI3** Input delay pulse limitation timer with control contact
- EI2** Input delay pulse with control contact
- I3** Pulse detection

Time ranges

Adjustable 0,05 s ... 100 h

Output relay

2 changers potential free 250 Vac / 8 A

Indicators

- Green LED ON: indication of supply voltage
- Green LED flashes slowly: indication of time t1
- Green LED flashes fast: indication of time t2
- Yellow LED ON/OFF: indication of relay output

Supply voltage

12 ... 240 Vac/dc -10% +10%

AC 48 ... 63 Hz, 100% duration of operation

Reference data

Selectron® MFT	Article no.
MFT ITU24S	41130005
(Order data see chapter 1)	

Multifunction clock-pulse generator relay

MFT ITU24S

Technical data	
Input circuit	MFT IT14S
12 ... 240 Vac/dc	6 VA / 2 W
Residual ripple for dc	10%
Drop-out voltage	>30% of minimum rated supply voltage
Control contact / Voltage controlled	
Parallel switching of loads possible	
Input not potential free	terminals A1 - B1
Trigger level (sensitivity)	automatic adapted to supply voltage
Max. line length	10 m
Min. control pulse length	DC 50 ms / AC 100 ms
Accuracy	
Base accuracy	±1% of the scale limit
Repeatability of the scale limit	<0,5% or ±5 ms
Adjustment accuracy	<5% of the scale limit
Temperature influence	≤0,01% / °C
Reaction times	
Recovery time	100 ms

Type key

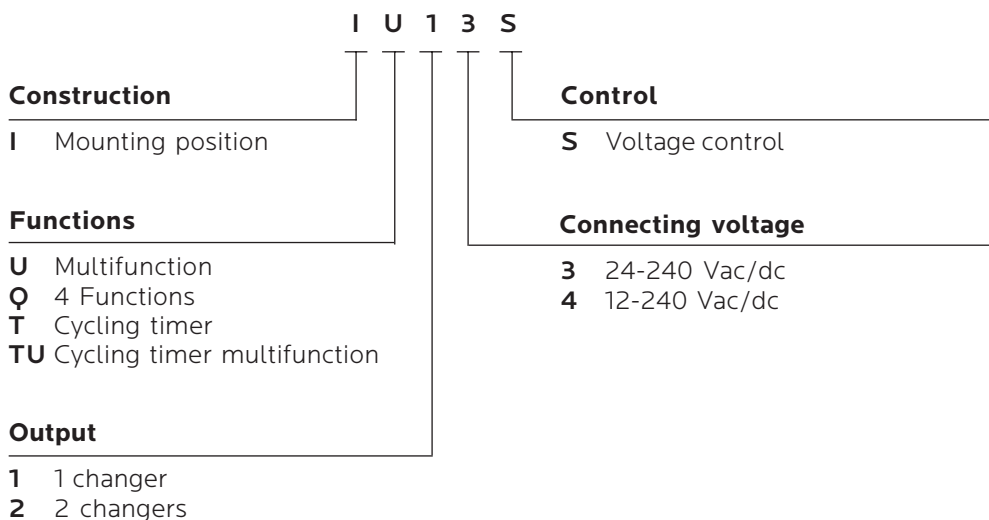

Multifunction clock-pulse generator relay

MFT ITU24S

Function descriptions

TP - Cycling timer relay beginning on a pause

When the supply voltage U is applied, the set interval t1 begins (green LED U/t flashes slowly). After the interval t1 has

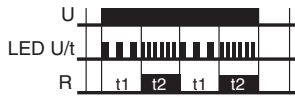

expired, the output relay switches into on-position (yellow LED illuminated) and the set interval t2 begins (green LED U/t flashes fast). After the interval t2 has expired, the output relay switches into off-position (yellow LED not illuminated).

The output relay is triggered in the ratio of the two set intervals until the supply voltage is interrupted.

TI - Cycling timer relay beginning on a pulse

When the supply voltage is applied, the output relay R switches into on-position (yellow LED illuminated) and the set

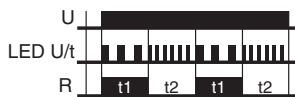

interval t1 begins (green LED U/t flashes slowly). After the interval t1 has expired, the output relay switches into off-position (yellow LED not illuminated) and the set interval t2 begins (green LED U/t flashes fast). After the interval t2 has expired, the output relay switches into on-position again (yellow LED illuminated).

The output relay is triggered in the ratio of the two set intervals until the supply voltage is interrupted.

EA -Delay on and delay off

The supply voltage U must be constantly applied to the device (green LED U/t illuminated). When the control contact

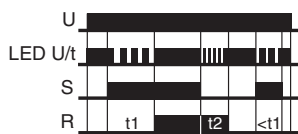

S is closed, the set interval t1 begins (green LED U/t flashes slowly). After the interval t1 has expired, the output relay R switches into on-position (yellow LED illuminated). When the control contact S is opened, the set interval t2 begins (green LED U/t flashes fast). After the interval t2 has expired, the output relay switches into off-position (yellow LED not illuminated). If the control contact S is opened before the interval t1 has expired, the interval already expired is erased and is restarted with the next cycle.

EI1 - Input delay pulse limitation timer voltage control

When the supply voltage U is applied, the set interval t1 begins (green LED U/t flashes slowly). After the interval t1 has

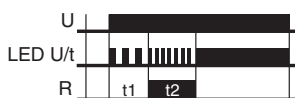

expired, the output relay switches into on-position (yellow

LED illuminated) and the set interval t2 begins (green LED U/t flashes fast). After the interval t2 has expired, the output relay switches into off-position (yellow LED not illuminated). If the supply voltage is interrupted before the interval t1+t2 has expired, the interval already expired is erased and is restarted when the supply voltage is next applied.

EI3 - Input delay pulse limitation timer with control contact

The supply voltage U must be constantly applied to the device (green LED U/t illuminated). When the control contact S is

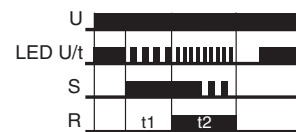

closed, the set interval t1 begins (green LED U/t flashes slowly). After the interval t1 has expired, the output relay switches into on-position (yellow LED illuminated) and the set interval t2 begins (green LED U/t flashes fast). After the interval t2 has expired, the output relay switches into off-position (yellow LED not illuminated). During the interval, the control contact can be operated any number of times. A further cycle can only be started when the cycle run has been completed.

EI2 - Input delay pulse with control contact

The supply voltage U must be constantly applied to the device (green LED U/t illuminated). When the control contact S is closed,

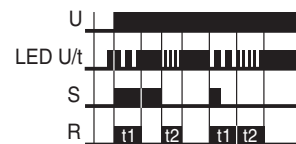

the output relay R switches into on-position (yellow LED illuminated) and the set interval t1 begins (green LED U/t flashes slowly). After the interval t1 has expired, the output relay switches into off-position (yellow LED not illuminated). When the control contact is opened, the output relay switches into on-position again (yellow LED illuminated) and the set interval t2 begins (green LED U/t flashes fast). After the interval t2 has expired, the output relay switches into off-position again. During the interval, the control contact can be operated any number of times.

I3 - Pulse detection

When the supply voltage U is applied, the set interval t1 begins (green LED U/t flashes slowly) and the output relay R switches into on-position

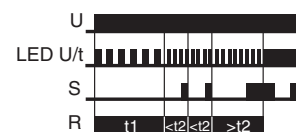

(yellow LED illuminated). After the interval t1 has expired, the set interval t2 begins (green LED U/t flashes fast). For the output relay to remain in on-position, the control contact S must be closed and reopened within the set interval t2. If this does not occur, the output relay R switches into off-position (yellow LED not illuminated) and all further pulses at the control contact S are ignored. To restart the function, the supply voltage must be interrupted and reapplied.

Multifunction clock-pulse generator relay

MFT ITU24S

Connection

MFT ITU24S

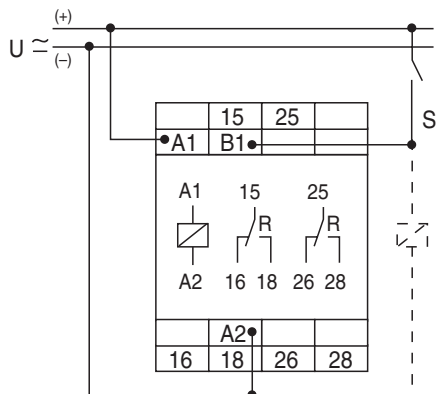

Load limit curves

MFT ITU24S

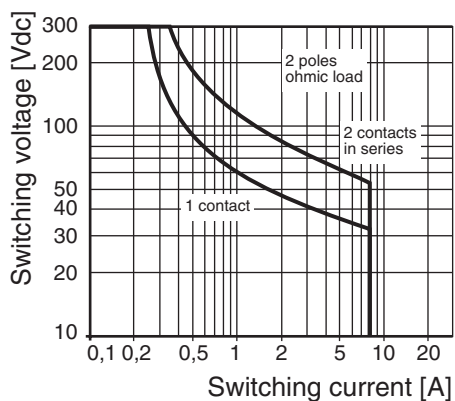

Dimensions

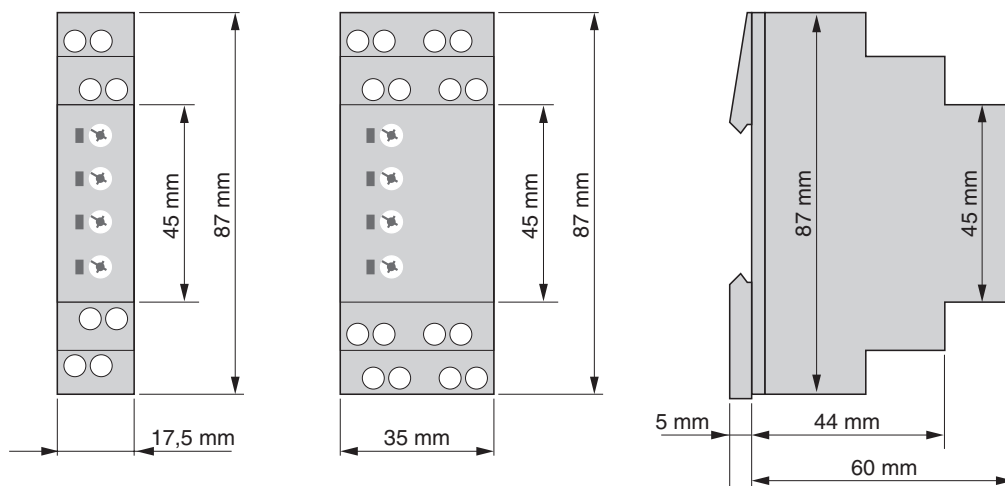

Technical safety advice

This manual contains the information necessary for the correct utilisation of the products described therein. It is intended for technically qualified persons who are involved as either

- planning engineers familiar with the safety concepts of automation technology;
- or, operating personnel, who have been instructed in handling automation equipment and have a knowledge of the contents of this manual concerning operation;
- or, installation and servicing personnel possessing the necessary training to repair such an automation system or who have the authority to put such circuits and equipment/systems into operation, to earth or label them according to the relevant safety standards.

The products are constructed, manufactured and tested in compliance with the relevant VDE standards, VDE specifications and IEC recommendations.

Danger warning

These warnings serve both as a guide for those persons involved in a project and as safety advice to prevent damage to the products themselves or to associated equipment.

Due to advancements in technology, the wiring diagram on the actual device may be different than shown in this catalogue. In all instances where the actual device diagram is different, the wiring diagram on the device must be used when electrical connections are made.

Correct utilisation, configuration and assembly

The equipment is to be used only for the applications stated in the catalogue and technical literature, and only in conjunction with auxiliary equipment and devices that are recommended or approved by Selectron Systems Ltd.

Further, it should be noted that:

- the automation equipment must be disconnected from any power supply before it is assembled, disassembled or the configuration modified.

- Solid state electronic switches must not be tested with incandescent lamps or connected to a load that exceeds its rating.
- trouble-free and safe operation of the products requires correct transportation as well as appropriate storage, assembly and wiring.
- the systems may only be installed by trained personnel. In doing so, the relevant requirements contained in VDE 0100, VDE 0113, IEC 364, etc. must be complied with.

Prevention of material damage or personal injury

Additional external safety devices or facilities must be provided wherever significant material damage or even personal injury could result from a fault occurring in an automation system. A defined operating status must be ensured or forced by such devices or facilities (e.g. by independent limit switches, mechanical interlocks, etc.).

Advice concerning planning and installation of the products

- The safety and accident prevention measures applicable to a specific application are to be observed.
- In the case of mains-operated equipment, a check is to be made before putting it into operation to ensure that the preset mains voltage range is suitable for the local supply.
- In the case of a 24 V supply, care must be taken to ensure sufficient electrical insulation of the secondary side. Use only mains power supply units that conform to IEC 364-4-41 or HD 384.04.41 (VDE 0100 Part 410).
- Automation systems and their operating elements are to be installed in such a way that they are sufficiently protected against accidental operation.

Warranty

Selectron Systems Ltd. warrants its products to be free from defects in material and workmanship for a period of one year from the date of shipment. All claims under this warranty must be made within thirty (30) days of the discovery of the defect, and all defective products must be returned at the buyer's expense. Buyer's sole and exclusive right will be limited to, at the option of Selectron Systems Ltd., the repair or replacement by Selectron Systems Ltd., of any defective products for which a claim is made.

In all other matters please refer to the "General terms of business" concerning Selectron Systems Ltd.

Note

The information given in this documentation corresponds to the state of development at the time of going to press and is therefore not binding. Selectron Systems Ltd. reserves the right to make alterations in the interests of technical advancement or product improvement at any time without giving reasons for doing so.

Prescriptions and standards

Mechanical data	
Housings in self-extinguishing plastic material. Protection mode IP 40	
Fixing on profile rail TS 35 according to EN 50 022	
Connection mark according to IEC67-1-18a	
Environmental conditions	
Admissible environmental temperatures from -25 °C ... +55 °C (corresponds IEC 68-1)	
Storage and transport temperature from -25 °C ... +70 °C	
Relative humidity 15% to 85% (according to IEC 721-3-3 class 3K3)	
Pollution degree 2, if built-in 3 (according to IEC 664-1)	
Vibration resistance 10 to 55 Hz 0,35 mm (according to IEC 68-2-6)	
Shock resistance 15 g 11 ms (according to IEC 68-2-27)	
Output relay	
Electrical lifetime:	2 x 10 ⁶ switching cycles at 1000 VA ohmic load
Mechanical lifetime:	20 x 10 ⁶ switching cycles
Contact material	AgNi 0,15
Supply voltage	
Frequency range	48 ... 63 Hz
Duty cycle	100%, IEC class 1c
Protection	
Protection of the unit	8 A fast
Terminals	
Contact protection according VDE 0106 and VBG 4	
Terminal arrangement and connecting mark according DIN 46 199	
Terminal type:	Terminal connection according to VBG 4 (PZ1 required)
Terminal variants:	1 wire 0,5 mm ² ... 2,5 mm ² with/without wire end covers
	1 wire 4 mm ² without wire end covers
	2 wires 0,5 mm ² ... 1,5 mm ² with/without wire end covers
	2 wires 2,5 mm ² flexible without wire end covers
max. screw in torque:	1,0 Nm
Insulation	
Overvoltage category	III (according to IEC 60664-1)
Rating surge voltage:	4 kV
Electromagnetic compatibility	
Electrostatic discharge:	6 kV contact, 8 kV air (corresponds to IEC 61000-4-2)
High frequency electromagnetic fields:	Level 3, 10 V/m (corresponds to IEC 61000-4-3)
Fast transients:	4 kV / 5 kHz, 5/50 ns (corresponds to IEC 61000-4-4)
Lightning discharge:	2 kV com., 1 kV dif., (corresponds to IEC 61000-4-5)
Cable running disturbances induced by HF fields: Level 3, 10 V RMS (corresponds to IEC 71000-4-6)	
Spurious radiation net and aerial network: Class B (corresponds to EN 55011)	
Prescriptions	
Air and leakage paces:	EN 61812-1 (see Insulation)
Test voltage:	EN 61812-1 (see Insulation)
Low voltage directions according to EN 61812-1 (see Insulation)	
EMC emissions:	IEC 61000-6-4
EMC interference stability:	IEC 61000-6-2
Burst:	4 kV / 5 kHz, 5/50 ns (corresponds to IEC 61000-4-4)
ESD:	6 kV contact, 8 kV air (corresponds to IEC 61000-4-2)
Production standard:	according to ISO 9001
Basic standards:	IEC 61000-6-4, IEC 61000-4-2