



MIA Series
56-160 Aluminium
Ex e IIC
Ex tb IIIC
Ex nA IIC
Ex tc IIIC

 **Drivetek as**
Regulerte motordrifter - www.dtc.no



 **RAEL MOTORI
ELETTICI**



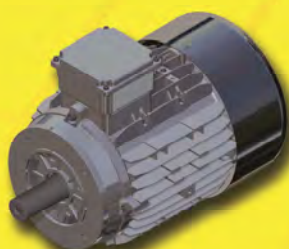

RAEL, founded in Genoa in 1969 as an electric motors repair and rewinding company, has grown to become an established name in projection and manufacture of electric motors for potentially explosive atmospheres. Since 1986 the company has grown considerably and moved to Predosa [AL] where both production and offices are actually located;

Through constant research of products which can offer a high qualitative standard and market competitiveness we are geared up with automated production system like CNC turning and machining centers of last generation, industrial robots, CNC grinding machine, inspection room with CMM machines, Computer controlled system for inline electrical test and Dynamometric braking test bench, automated assembly lines. We offer great flexibility in fulfilling special customer requirements. All of the above helped to place Rael among the leading producers of Explosion proof motors.

CONTENTS

1	TOLERANCES AND STANDARDS	4
1.1	Mechanical and electrical tolerances	4
1.2	Standards	5
2	HOW TO PICK THE RIGHT ELECTRIC MOTOR	6
2.1	Classify hazardous area	6
2.2	EX markings or RAEL electric motors	13
3	GENERAL INFORMATION	14
3.1	Motors range	14
3.2	Main features	15
3.3	Main options	16
4	CABLE ENTRIES, TERMINAL BOX AND WIRING DIAGRAM	17
4.1	Cable entries and terminal box	17
4.2	Wiring diagrams	18
5	MECHANICAL CHARACTERISTIC	19
5.1	Mounting arrangements	19
5.2	Main components material	20
5.3	Radial force permissible at the shaft end	21
6	ELECTRICAL DATA	22
6.1	General information	22
6.2	Three phase 1 speed motors	22
6.3	Three phase 2 speed motors constant torque	27
6.4	Three phase 2 speed quadratic torque	31
7	OVERALL DIMENSION	35
7.1	Three phase motors	35
8	SPARE PARTS	36
8.1	Personnel qualification	36
8.2	List of spare parts	36

1 TOLERANCES AND STANDARDS

1.1 Mechanical and electrical tolerances:

Symbol	Description	Tolerance	
A	Distance between centre-lines of fixing holes (end view)	± 1 mm	
AB	Overall dimensions across the feet (end view)	+ 2 %	
AC	Diameter of the motor (without terminal box)	+ 2 %	
B	Distance between centre-lines of fixing holes (side view)	± 1 mm	
C - CA	Distance from the shaft end shoulder to the centre-line of nearest mounting holes in the feet	± 3 mm	
D - DA	Diameter of the shaft extension.	\varnothing 11 – 28 \varnothing 32 – 48 \varnothing ≥ 55	j6 k6 m6
E - EA	Length of the shaft extension from the shoulder	\varnothing < 55 mm \varnothing > 60 mm	- 0,3 mm + 0,5 mm
F - FA	Width of the keyway of the shaft extension	h9	
GA - GC	Distance from the top of the key to the opposite surface of the shaft extension	+ 0,2 mm	
H	Distance between the centre-line of the shaft to the bottom of the feet	H ≤ 250 H ≥ 280	- 0,5 mm - 1 mm
HD	Distance from the top of the terminal box and to the bottom of the feet	+ 2 %	
K	Diameter of the holes or width of the slots in the feet of the motor	+ 3 %	
L	Overall length of the motor with a single shaft extension	+ 1 %	
M	Pitch circle diameter of the fixing holes	± 0,8 mm	
N	Diameter of the spigot	\varnothing < 230 \varnothing ≥ 250	j6 h6
P	Outside diameter of the flange	± 1 mm	
R	Distance from the shaft shoulder to the mounting surface of the flange	± 3 mm	
S	Diameter of the fixing holes in the mounting flange or nominal diameter of thread	+ 3 %	
	Distance from the shaft shoulder to the mounting surface of the flange with locked bearing	± 0,5 mm	
	Mass of the motor	Da – 5 a + 10 %	

Quantity	Tolerance
Efficiency (η)	- 0,15 (1- η) for $P_N \leq 50$ kW
Total losses	+10%
Power factor (Cos φ)	$\frac{1-\cos\varphi}{6}$ minimum absolute value 0,02 maximum absolute value 0,07
Slip (rpm) (at full load and working temperature)	± 30% per $P_N < 1$ kW ± 20% per $P_N \geq 1$ kW
Locked rotor current (I_A)	+ 20%
Locked rotor torque (T_A)	-15% a +25%
Breakdown torque (T_{max})	-10% (for this tolerance the value T_{max} / T_n should be at least 1,6)
Moment de Inertia (J)	±10%
Sound intensity level (sound pressure)	+3 dB (A)

1.2 Standards

RAEL electric motors conforms to the following standards:

TITLE	EU CENELEC	International IEC
Rotating electrical machines Part 1: Rating and performance	EN 60034-1	IEC 60034-1
Rotating electrical machines Part 2-1: Standard methods for determining losses and efficiency from tests (excluding machines for traction vehicles)	EN 60034-2	IEC 60034-2
Rotating electrical machines. Part 5: Degrees of protection provided by the integral design of rotating electrical machines (IP code). Classification	EN 60034-5	IEC 60034-5
Rotating electrical machines Part 6: Methods of cooling (IC Code)	EN 60034 -6	IEC 60034 -6
Rotating electrical machines Part 7: Classification of types of construction, mounting arrangements and terminal box position (IM Code)	EN 60034-7	IEC 60034-7
Rotating electrical machines Part 9: Noise limits	EN 60034-9	IEC 60034-9
Rotating electrical machines Part 12: Starting performance of single-speed three-phase cage induction motors	EN 60034-12	IEC 60034-12
Rotating electrical machines Part 14: Mechanical vibration of certain machines with shaft heights 56 mm and higher - Measurement, evaluation and limits of vibration severity	EN 60034-14	IEC 60034-14
General purpose three-phase induction motors having standard dimensions and outputs. Frame numbers 56 to 315 and flange numbers 65 to 740	EN 50347	IEC 60072-1
Degrees of protection provided by enclosures (IP Code)	EN 60259	IEC 60529
Electrical apparatus for explosive gas atmospheres Part 0: General requirements	EN 60079-0	IEC 60079-0
Electrical apparatus for explosive gas atmospheres Part 7: Increased safety "e"	EN 60079-7	IEC 60079-7
Electrical apparatus with protection type by enclosure 't' to be use in the presence of combustible dust	EN 60079-31	IEC 60079-31



2 HOW TO PICK THE RIGHT ELECTRIC MOTOR

2.1 Classify hazardous area

The first step is determining the proper hazardous area classification.

When an electric motor is to be operated in a location that contains hazardous materials, it is the responsibility of the end-user to determine the applicable class, category and group.

There are a number of ways to prevent sparks, heat or short-circuits from causing ignition of the explosive atmosphere.

Generally electric motors are available in the following protection types:

Flameproof, Increased safety, Non-sparking, for other protection types please see the table below.

ZONE & CATEGORY CLASSIFICATION				
GAS	DUST	CATEGORY	PROTECTION LEVEL	DESCRIPTION
0	20	1	Very high	Explosive atmospheres are present continually or for long periods or frequently
1	21	2	High	Explosive atmospheres are likely to occur under normal operations, occasionally
2	22	3	Normal	Explosive atmospheres are not expected to occur under normal operations. Where they do occur, it will be for a short period only.

PROTECTION TYPE				
CODE		PROTECTION BY	SUITABLE FOR ZONES	
GAS	DUST		GAS	DUST
d		Flameproof Enclosure	1	
	ta	Enclosure		20
	<u>tb</u>			21
	<u>tc</u>			22
px	pD	Pressurized Enclosure	1	21/22
py	pD		1	21/22
pz	pD		2	21/22
q		Powder filling	1	
o		Oil immersion	1	
<u>e</u>		Increased safety	1	
ia	ia	Intrinsic safety	0	20
ib	ib		1	21
ic	ic		2	22
<u>nA</u>		Non sparking	2	
nR		Restricted breathing enclosures	2	
nL		Limited energy	2	
nC		Enclosed break	2	
ma	ma	Encapsulation	0	20
mb	mb		1	21
mc	mc		2	22

RAEL MIA and MIA1 motors are available in the underscored protection type

ATMOSPHERE

An explosive atmosphere can be one in the form of gases, vapours, mists or dusts, which can ignite under certain operating conditions.

For ATEX purposes, atmosphere comes in two classifications: “**G**” for explosive gas and “**D**” for combustible dust. A product certified for both gas and dust is marked **G** and **D**

ZONES

The division of a hazardous area into zones depending on the frequency with which explosive atmosphere occurs. ATEX divides hazardous environment into zones and states which category of equipment that can be used in each zone. Atmospheres are classified into zones.

Zones 0, 1 and **2** refer to gas, while **Zones 20, 21** and **22** refer to dust.

GROUP

Under the ATEX Directive, equipment is designated by the type of potentially explosive atmosphere in which the equipment may be used :

-Group 1 (I) The underground parts of mines, and to those parts of surface installations of mines, that are liable to be endangered by firedamp (methane) and/or combustible dust.

-Group 2 (II) for surface industries.

CATEGORY

Hazardous area equipment is arranged in categories depending on its degree of protection, indicating where the item can be used:

-Category 1

Equipment designed for very high level of safety. Requires two independent means of protection or safe operation with two separate faults. Used where explosive atmospheres are present continuously or for lengthy periods, typically **Zone 0** and **Zone 20**.

-Category 2

Equipment designed for a high level of safety. Requires the design to be safe with frequently occurring disturbances or with one operating fault. Used where explosive atmospheres are likely to occur, typically **Zone 1** and **Zone 21**.

-Category 3

Equipment designed for a normal level of safety. Used where explosive atmospheres are likely to occur infrequently and to be of short duration, typically **Zone 2** and **Zone 22**.

CLASSIFICATION OF GAS GROUP

ATEX defines four groups of gases, based on how easily-ignitable they are (by a flame or spark; not via self-ignition).

Group I (mining) there is only one gas group, namely methane.

Group II is subdivided into **IIA**, **IIB**, **IIC**. Electrical apparatus certified for **IIB** may be used in applications requiring apparatus to be certified for group **IIA**. Electrical apparatus certified for **IIC** may be used in applications requiring apparatus to be certified for groups **IIA** and **IIB**.

GAS GROUP	COMMON GASES
I (Mining)	Methane
IIA	Propane, ethanol, ammonia, butane..
IIB	Ethylene, hydrogen sulphide..
IIC	Hydrogen, Acetylene..

The table at page 11 indicates the groups to which some gas mixtures belong



CLASSIFICATION OF DUSTS

With ATEX, combustible dust is for the first time included in the regulations governing hazardous atmospheres. Typical applications include handling of grain, coal, sugar, wood and some chemical substances such as sulphur. IEC 60079-0 defines the new atmosphere group III for explosive dusts in surface industries (i.e. ATEX group II). There are three “dust groups” in the standard, defined by the properties of the dust:

DUST GROUP	TYPE	CHARACTERISTICS
IIIA	Combustible flyings	Finely divided solid particles, 500 µm or less in nominal size, which may be suspended in air, may settle out of the atmosphere under their own weight, may burn or glow in air, and may form explosive mixtures with air at atmospheric pressure and normal temperatures.
IIIB	Non-conductive dust	Combustible dust with electrical resistivity greater than 10 ³ Ω.m
IIIC	Conductive dust	Combustible dust with electrical resistivity equal to or less than 10 ³ Ω.m

The self-ignition temperature of a dust suspended in the air is usually higher than the same dust accumulated on a surface. When selecting equipment for use in dusty environments, the surface temperature of the equipment should not exceed **2/3** of the suspended self-ignition temperature, and should be at least **75°C below** the self-ignition temperature of a **5mm accumulated layer of the dust**.

For example, cotton has self-ignition temperatures of 560°C (suspended) and 350°C (accumulated). Your equipment's maximum surface temperature must be less than 373°C (suspended) and 275°C (accumulated), so the limit is 275°C. Equipment classified T3 (200°C) is acceptable, but T2 (300°C) is not.

Table at page 12 indicates a list of main substance and raw material and their ignition property

TEMPERATURE CLASS

Rather than mark equipment with an actual temperature to show how hot it gets in operation, a temperature class is used.

The T-class is based on the hottest surface where igniting the flammable gas would destroy the protection. Generally, T-class is based on fault conditions or, at the very least, worst case normal operating conditions. When selecting equipment, the T-class must be below the auto-ignition temperature of the gas.

For dust explosion proof, the max surface temperature is directly shown (e.g.T80°C)

TEMPERATURE CLASS	MAXIMUM SURFACE TEMP (C°)	IGNITION TEMPERATURE
T1	450	>450
T2	300	>300
T3	200	>200
T4	135	>135
T5	100	>100
T6	85	>85

IP PROTECTION RATING

The “Ingress Protection” rating defined in IEC / EN 60034-5 is a measure of the resistance of an enclosure to penetration by dust or liquid, and is not specifically an Ex concept.

Several of the EN/IEC standards do require the IP rating to be shown as part of the Explosion Classification, but having an IP rating in and of itself is not proof the equipment is safe to use in an explosive atmosphere.

Note that the IP rating system considers ingress which is “harmful”, so an IPx8 product may still show some ingress of water when submersed, but not enough to cause any malfunction.

Solid particle protection:

The **first digit** indicates the level of protection that the enclosure provides against access to hazardous parts (e.g., electrical conductors, moving parts) and the ingress of solid foreign objects.

Liquid ingress protection:

The **second digit** indicates the level of protection that the enclosure provides against harmful ingress of water

FIRST NUMBER		SECOND NUMBER	
IP	PROTECTION PROVIDED	IP	PROTECTION PROVIDED
0	No Protection	0	No Protection
1	Protection against solid objects - 50mm	1	Protection against vertical drops of water (showerproof)
2	Protection against solid objects - 12mm	2	Protection of up to 15 deg vertical direct sprays of water (rainproof)
3	Protection against solid objects - 2.5mm	3	Protection of up to 60 deg vertical direct sprays of water
4	Protection against solid objects - 1mm	4	Protection from water sprayed in all directions
5	Limited Protection against dust	5	Protection from low pressure jets of water in all directions
6	Complete protection against dust	6	Protection from strong jets of water
		7	Protection from temporary immersion of up to 1m for 30 mins
		8	Protection from Complete immersion for specified depth and unlimited time

EQUIPMENT PROTECTION LEVEL (EPL)

IEC 60079 standards now include provision for equipment on the basis of risk.

If the consequences of an explosion are deemed particularly severe, then to decrease the risk, the category/zone relationship can be changed to give a lower possibility of ignition.

So category 2 apparatus could be selected for use in a zone 2 for instance:

GROUP	EPL	INTENDED FOR EQUIPMENT GROUP	GIVING PROTECTION
Group I	Ma	Equipment for mining	High level of protection against becoming an ignition source
	Mb		Level of protection which can be electrically isolated if hazardous atmosphere is known to exist
Group II	Ga	Equipment for explosive gas atmospheres	Very High level of protection against becoming an ignition source
	Gb		High level of protection against becoming an ignition source
	Gc		Assured level of protection against becoming an ignition source in normal operation
Group III	Da	Equipment for explosive dust atmospheres	Very High level of protection against becoming an ignition source
	Db		High level of protection against becoming an ignition source
	Dc		Assured level of protection against becoming an ignition source in normal operation

RAEL motors series MIA and MIA1 have the following types of protection:

-Ex e IIC Increased safety (GAS) or Ex tb IIIC enclosures (DUST) or both markings

-Ex nA IIC Non-sparking (GAS) or Ex tc IIIC enclosures (DUST) or both markings

Increased safety Ex e (MIA Series motor)

The motor with increased safety prevents sparking, arcing and hot spots during the service (including start conditions at locked rotor), which could lead to ignition of a potential explosive atmosphere that surrounds both the internal and external parts of the engine.

This is ensured under certain constructional and dimensional information concerning:

- Minimum distances through air and between the surfaces
- Use of high resistance trace-proof insulating materials
- Elimination of sharp edges that may accumulate static electricity and verification of a correct coupling between electrical and mechanical parts.
- minimum distance between the fixed and rotating parts (eg. between iron rotor / stator)
- limits of temperature rise, considering the locked rotor situation and normal operation in the most unfavorable thermal condition (power supply voltage to the lower or upper tolerance limit).

Thermal protection

a) When the protection against over temperatures is realized via amperometric device, it will be listed on the plate the ratio between the currents I_A / I_N and the time t_E (t_E must not be less than 5 sec while I_A / I_N should not be than 10)

b) When the protection against over temperatures is achieved via thermal protectors, placed inside the windings and connected to a release device, will be reported in the plate only current ratio I_A / I_N . The time t_E should not be shown on the nameplate

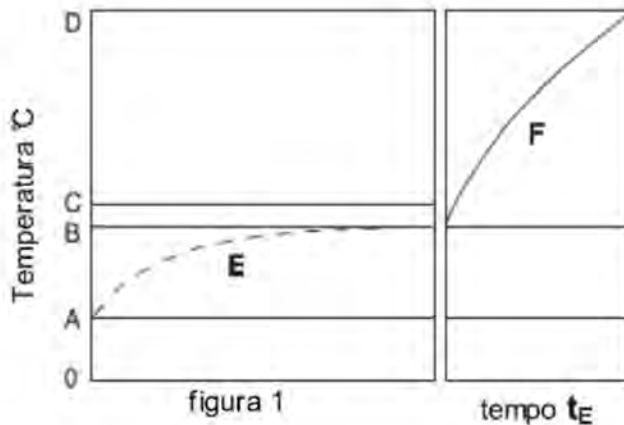

Ex nA protection (MIA1 Series motor)

This type of protection is allowed in hazardous areas classified as Zone 2, which require a normal protection. These constructions are known as non-sparking and the motor must be designed so that no spark is formed in the normal operating conditions. For the determination of the maximum allowable temperature are therefore excluding start-up situations with locked rotor

Protection through enclosures Ex tb (MIA) ed Ex tc (MIA1)

This type of protection prevents each transmission of explosive powders because the degree of IP protection prevents the dust from entering inside the motor, the maximum surface temperature of the motor does not exceed the temperature limit and no spark can escape from the housing of the motor.

Main inflammable gases, group and temperature class belonging (IIA, IIB, IIC) and temperature of ignition.

Inflammable substance	Group of GAS	temperature of ignition	Class of Temperature (°C)	Inflammable substance	Group of GAS	temperature of ignition	Class of Temperature (°C)
2-Methylpentane	IIA	300	T2	Ethyl formate	IIA	440	T2
Amyl acetate	IIA	360	T2	Methyl formate	IIA	450	T1
Butyl-n acetate	IIA	425	T2	Natural gas	IIA	482	T1
Ethyl acetate	IIA	426	T2	Isobutane	IIA	460	T1
Isobutil acetate	IIA	420	T2	Isoheptane	IIA	220	T3
Methyl acetate	IIA	502	T1	Isohexane	IIA	264	T3
Propil acetate	IIA	430	T2	Isooctane	IIA	410	T2
Vinyl acetate	IIA	425	T2	Isoprene	IIA	220	T3
Acetone	IIA	465	T1	Methane	IIA	537	T1
Methanol	IIA	464	T1	Methylcyclopentane	IIA	258	T3
Bromethane	IIA	511	T1	Methylamine	IIA	430	T2
Butane	IIA	287	T3	Methylmetacrylate	IIA	430	T2
Butene - 1	IIA	384	T2	Paraldehyde	IIA	239	T3
Butene - 2	IIA	325	T2	Pentane	IIA	258	T3
Cycloexano	IIA	259	T3	Pyridine	IIA	483	T1
Cycloexanol	IIA	300	T2	Propane	IIA	470	T1
Cyclohexanone	IIA	419	T2	Propylamine	IIA	318	T2
Cyclohexene	IIA	244	T3	Propylbenzene	IIA	450	T1
Cyclopropane	IIA	498	T1	Propylene	IIA	455	T1
Cymene (p)	IIA	436	T2	Styrene	IIA	490	T1
Chloro-benzene	IIA	637	T1	Toluene	IIA	480	T1
Acetyl chloride	IIA	390	T2	m-Xylene	IIA	522	T1
Allyl chloride	IIA	390	T2	o-Xylene	IIA	464	T1
Chlorbutane	IIA	240	T3	p-Xylene	IIA	528	T1
Chloroethane	IIA	495	T1	1,2 Butadiene	IIB	430	T2
Vinyl chloride	IIA	472	T1	1,3 Butadiene	IIB	430	T2
Dichlorobenzene	IIA	648	T1	Dioxane	IIB	245	T3
Dichloroethylene 1,1	IIA	570	T1	Diethyl ether	IIB	160	T4
Dichloroethylene 1,2	IIA	441	T2	Ethyl vinyl ether	IIB	200	T3
Diethylamine	IIA	312	T2	Methyl vinyl ether	IIB	350	T2
Dimethylamine	IIA	400	T2	Acrylate ethyl	IIB	350	T2
Dimethylaniline	IIA	371	T2	Ethylene	IIB	425	T2
Dimethylbutane 2,3	IIA	405	T2	LPG	IIB	365	T2
Dimethylpentane 2,3	IIA	330	T2	Sulphurated Hydrogen	IIB	260	T3
Heptane	IIA	215	T3	Methylacrylate	IIB	415	T2
Hexane	IIA	233	T3	Carbon monoxide	IIB	605	T1
Heptane	IIA	515	T1	Ethylene oxide	IIB	435	T2
Ethylacetoacetate	IIA	350	T2	Propylene oxide	IIB	430	T2
Ethylamine	IIA	385	T2	Acetylene	IIC	305	T2
Ethylmercaptane	IIA	295	T3	Hydrogen	IIC	500	T1
Butyl formate	IIA	320	T2	Carbon disulfide	IIC	95	T6

Main inflammable DUSTS and their typical ignition temperature

Substance	Medium largeness particles (µm)	LEL (g/m ³)	Cloud ignition temperature (C°)	Layer 5mm thick ignition temperature (C°)
Metals, alloys				
Aluminium	10	60	560	430
Bronze	18	750	390	260
Iron	12	500	580	>450
Graphite	7	30	600	680
Lamp-black (carbon black)	13	15	620	435
Sulphur	20	30	280	260
Wood, products of wood, fibres				
Paper		100	620	370
Cellulose (93% sweet wood, 6% hard wood)	14	15	420	335
wood flour	60		470	305
Wood (50% pear tree and 50% kernel)	35	100	500	340
Wood (beech)	61		490	310
Wood (pear tree)	27	100	500	320
Sawdust of wood	65		470	290
Cork	42	30	470	300
Agricultural products				
Cacao	3	125	460-540	245
Coffee	10	25	360	450
Cereals (mixed powders)	37	125	510	300
Wheat flour	56-125	60	480	>450
Soy flour	20	200	620	280
Gelatine	65	60	560	>450
Wheat		100	470	220
Dry milk	165	60	460	330
Milk sugar	22	60-125	450	>450
Rye			415-470	325
Buttermilk	400		450	420
Tobacco		60	485	290
Black tea	76	125	510	300
Sugar	32	30	360	>450
Powdered sugar	17	60	350	>450

Marking example

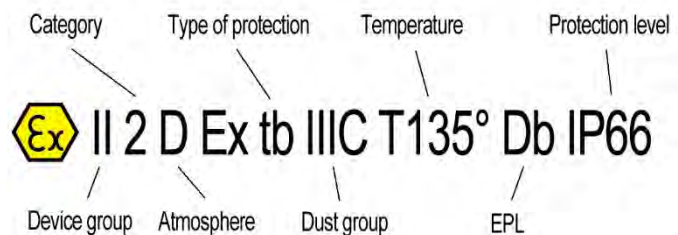
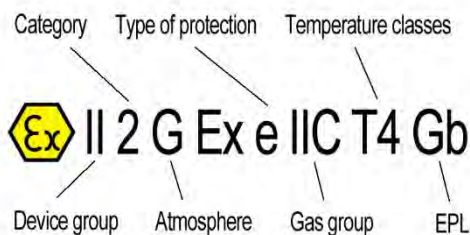

2.2 EX markings or RAEL electric motors

RAEL Ex motors have been designed to be used in applications with the presence of an explosive atmosphere due both to the presence of gases that the presence of combustible dust.

Motors for zone 1 and 21 (redundant for areas 2 e 22)

Ex **CE** **RAEL** **MOTORI ELETTRICI** TUV IT 12 ATEX 068X
 15077 Predosa (AL) ITALY Tel: +39 13171563 web site: www.raelsrl.com

N° Year
 Type Kg

PH	INS	Cosφ	Th.p.
V	Hz	A	rpm

DO NOT OPEN WHILE ENERGIZED Ta -40°C + 60°C IP 66
II 2G Ex e IIC T4 Gb **II 2DEx tb IIIC T 135°C Db**

IP 55 when there is the GAS marking
 DUST marking
 GAS marking

In case of a gas and dust protected motor the marking is the one on the nameplate above

Motors for zone 2 and 22

Ex **CE** **RAEL** **MOTORI ELETTRICI** TUV IT 12 ATEX 069x
 15077 Predosa (AL) ITALY Tel: +39 13171563 web site: www.raelsrl.com

N° Year
 Type Kg

PH	INS	cosφ	Th.p.
V	Hz	A	rpm

DO NOT OPEN WHILE ENERGIZED Ta -40°C + 60°C IP 66
II 3G Ex nA IIC T4 Gc **II 3D Ex tc IIIC T135°C Dc**

IP 55 when there is the GAS marking
 DUST marking
 GAS marking

In case of a gas and dust protected motor the marking is the one on the nameplate above

3 GENERAL INFORMATION

3.1 Motors range

MIA and MIA1 series motors in this catalog are manufactured according to European standards of equipment and protective systems suitable for potentially explosive atmospheres in accordance with ATEX Directive 94/9/EC.

These motors according to ATEX directives are provided:

- Certificate of EC type
- Notification of Quality Assurance Product

These certificates are issued by notified bodies authorized to issue.

Series motors MIA (MIA 1) with IP55 protection are suitable for use in area 1 and area 2, while the IP66 are also suitable for use in zone 21 and zone 22.

Version	Frame size (mm)	Power (kW)	Poles	GAS group	Temperature class motors 2G	Surface temperature motors 2GD	Ambient temperature
Three phase 1 speed 2 - 4 - 6 - 8 Poli	56 – 160	0,06 – 18,5	2	IIC	T4	T 135 °C	-40°C a +60°C
		0,06 – 15	4		T5	T 100 °C	
		0,035 – 11	6		T6	T 85 °C	
		0,06 - 7,5	8				
Three phase 2 speed Constant torque 2/4 - 4/8 – 4/6 – 6/8 poles	63 – 160	0,25/0,18 - 15/12	2/4	IIC	T4	T 135 °C	-40°C a +60°C
		0,18/0,09 – 10/6,6	4/8		T5	T 100 °C	
		0,2/0,1 – 8,8/5,9	4/6		T6	T 85 °C	
		0,08/0,12 – 5,5/4	6/8				
Three phase 2 speeds Quadratic torque 2/4 - 4/8 – 4/6 – 6/8 poles	63 – 160	0,25/0,06 – 16/4,4	2/4	IIC	T4	T 135 °C	-40°C a +60°C
		0,25/0,05 – 12/3,2	4/8		T5	T 100 °C	
		0,3/0,1 – 11/3,3	4/6		T6	T 85 °C	
		0,33/0,09 – 7,5/4	6/8				
Three phase for Inverter 2 - 4 - 6 - 8 Poli	56 – 160	0,06 – 18,5	2	IIC	T4	T 135 °C	-40°C a +60°C
		0,06 – 15	4				
		0,035 – 11	6				
		0,06 – 7,5	8				
		0,06 – 1,6	4				
		0,06 – 1,1	6				

3.2 Main features

Motors MIA and MIA1 are in conformity with the Essential Health and Safety Requirements for potentially explosive atmospheres provided by European Standards: EN 60079-0, EN 60079-7, EN 60079-15 , EN 60079-31.

- Three-phase and single-phase squirrel cage asynchronous induction motors.
- Aluminium modular motors, flanges and feet can be assembled and disassembled.
- Type of protection  Ex e, (Ex tb) Ex nA, (Ex tc)
- Overall dimensions comply with IEC 60072 .
- Ventilations **IC 411** (Self ventilated).
- Voltage 230/400 V \pm 5% Δ /Y (56 - 112), 400/690 V \pm 5% Δ /Y (132 - 160), frequency 50 Hz \pm 2%.
- Insulation Class F.
- Wiring produced using enamelled copper wires with double insulating coat, and varnished with a third layer dried in oven.
- Protection degree IP55 for area 1 and area 2, IP66 for area 21 and area 22.
- Maximum noise level 80 dB (A).
- Fan cover in sheet metal
- Low friction dust seals.
- Motor carcass and flanges IEC 60072-1 compliant, made using die cast aluminum with high mechanical strength
- Durt cycle S1
- Standard ambient temperature -40 °C; +60 °C

3.3 Main options

- Motors 2D protection degree IP66 suitable for zone 21 and zone 22(MIA) , and 3D for zone 22 (MIA1)
- Special Powers on frame 132 and 160
- Thermal protections (PTC or PTO probes).
- Heating resistors anti condensation
- Insulation class H.
- Tropicalized motors
- Motors suitable for inverters
- Special shafts
- Special flanges
- Terminal box in right and left position.
- Temperature class T5 and T6.
- Standard painting
- Special painting for marine environment

Tests

All motors RAEL are 100% tested, both at the beginning of production (test of winding) and at the end of production (electrical test).

On request we can conduct specific tests:

- Routine Test- a test to which each individual machine is subjected during or after manufacture to ascertain whether it complies with certain criteria
- Type test – a test of one or more machines made to a certain design to show that the design meets certain specifications
- Specific type test - a bench test performed on a machine with a specific serial number
- Heating test

4 CABLE ENTRY, TERMINAL BOX AND WIRING DIAGRAM

4.1 Cable entries and terminal box

Having the ability of mounting the feet in three different positions (size 63-71) is then possible to have the terminal box is at the top (A) on the right side (C) and on the left side (B) of the motor as shown in figure 1.

The terminal box can be mounted on the motor so as to have the output cables in the four positions shown in Figure 2. Standard installation of the terminal box is in position A-4

Entrata cavi	
Altezza d'asse	Standard
56 - 71	2 x M16
80 - 112	1 x M20 - 1 x M25
132-160	2 x M32

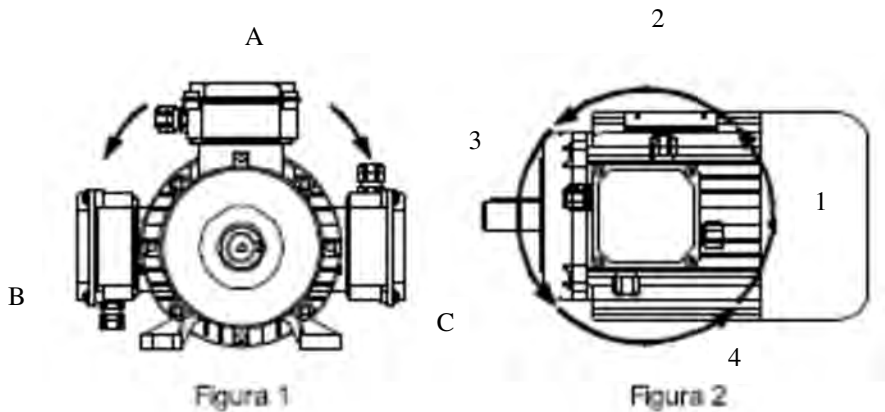

Motors with frame size from 56 to 90 use M4 terminals, motors with frame size 100 to 112 use M5 terminal, motors with frame size 132 to 160 use M6 terminals.

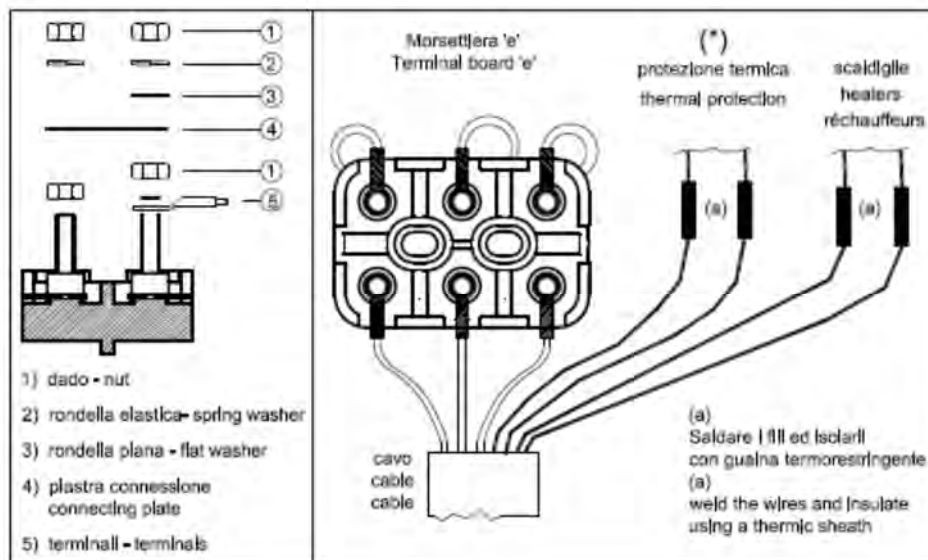

4.2 WIRING DIAGRAMS

Three phase 1 speed – Star and delta connection

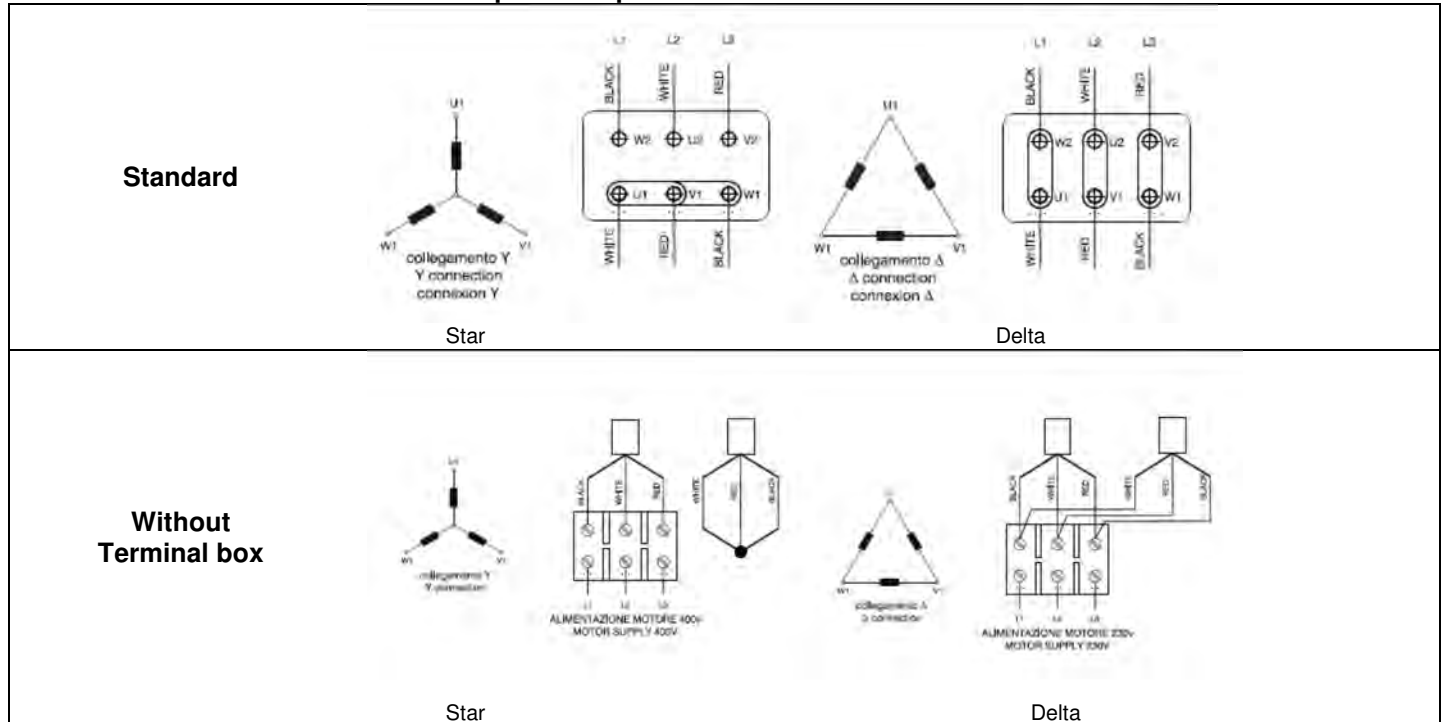

Three phase 2 speed – Dahlander Connection - 2/4 - 4/8 poles

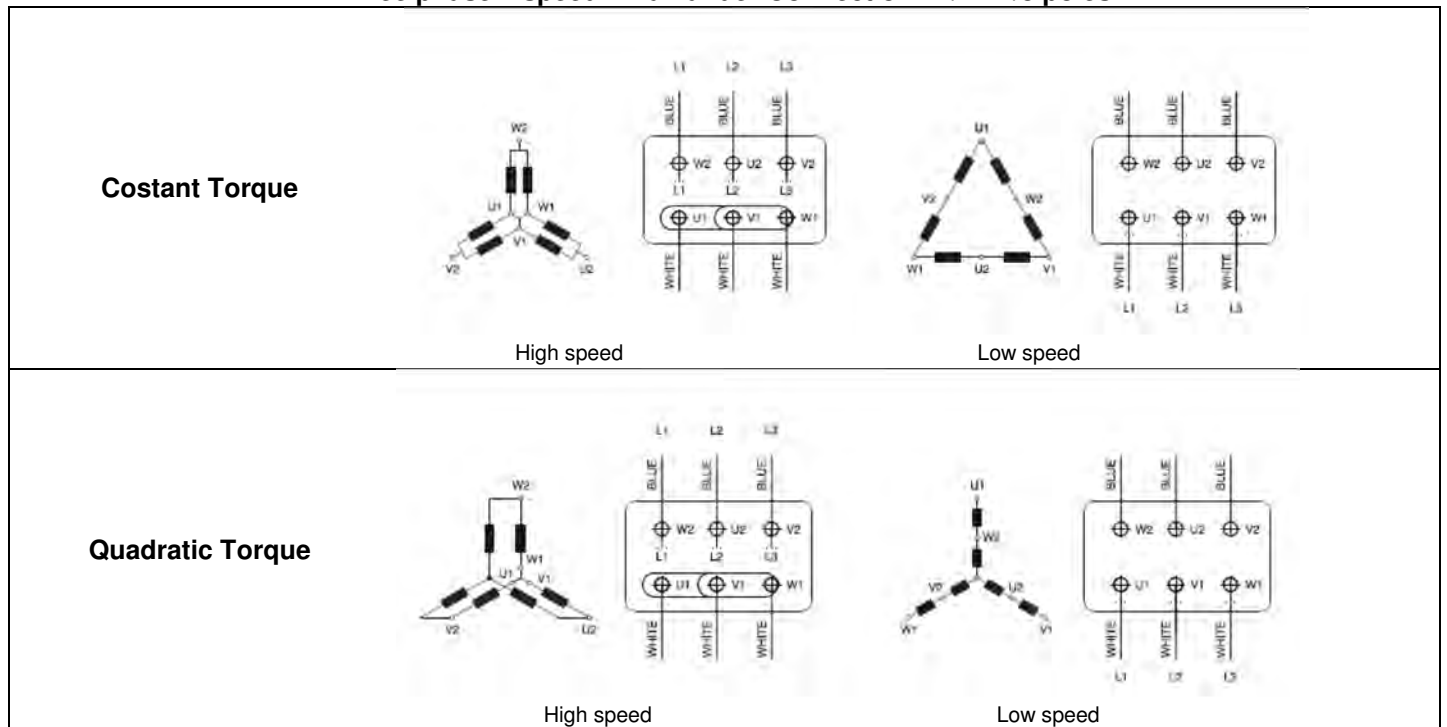

Three phase 2 speed – 2 separate windings - 4/6 - 6/8 poles

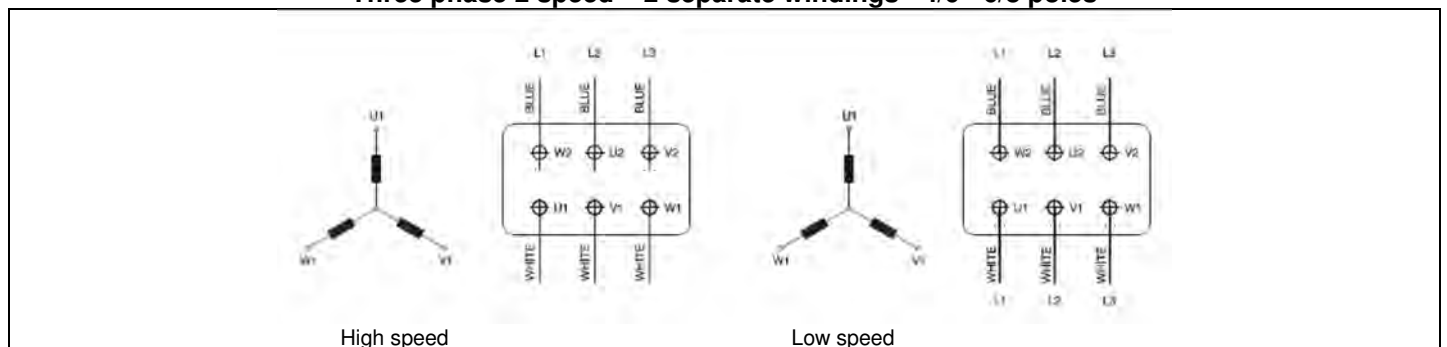

5 MECHANICAL CHARACTERISTICS

5.1 Mounting arrangements

MIA motors can be made in the mounting arrangements as shown in the table.

The basic mounting arrangements are shown in the standard EN 60034-7.

Motors with mounting arrangements IM B3, IM B5, IM B14 can also be used in different mounting positions.











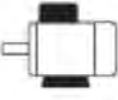

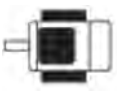
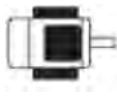
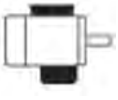
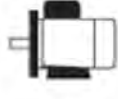







IM B3 IM B6, IM B7, IM B8, IM V5 o IM V6.

IM B35 IM V15 o IM V36, IM 2051, IM 2061, IM 2071.

IM B34 IM 2111 o IM 2131, IM 2151, IM 2161, IM 2171.

IM B5 IM V1 o IM V3. (flange with passing holes).

IM B14 IM V18 o IM V19. (flange with threaded holes).

COMMON MOUNTINGS	OTHER MOUNTINGS				
IM B3 IM 1001 	IM V5 IM 1011 	IM V6 IM 1031 	IM B6 IM 1051 	IM B7 IM 1061 	IM B8 IM 1071 
IM B35 IM 2001 	IM V15 IM 2011 	IM V36 IM 2031 	IM 2051 	IM 2061 	IM 2071 
IM B34 IM 2101 	IM 2111 	IM 2131 	IM 2151 	IM 2161 	IM 2171 
IM B5 IM 3001 	IM V1 IM 3011 	IM V3 IM 3031 			
IM B14 IM 3601 	IM V18 IM 3611 	IM V19 IM 3631 			



5.2 MAIN COMPONENTS MATERIAL

Material type

Shield fames flanges terminal box	Shaft	Rotor	Fan	Fan cover	Tie rods	Screw	Cable glands	Motor Plate
Aluminium	Steel 35S20	Die-cast Aluminium (squirrel cage)	Thermoplastic material or Aluminium	Zinc-plated steel	Steel 4.8	Steel 8.8	nickel-plated brass	Anodized aluminium or <i>on request</i> stainless steel

Bearings

The 2Z series bearings are lubricated for life and required not further lubrication. Nevertheless, we recommend in case of continuous running, long time stop, low temperature, radial and/or axial load, frequency inverter used, to control some time to time the ball bearings (40 000 hours for 4,6,8 pole motors and 20 000 hours for the 2 pole motors).

Motor		Bearing		Lubrication
Frame	Poles	Drive-end shield	Rear shield	
56	2 - 4 - 6 - 8	6201 2Z	6201 2Z	It doesn't need lubrication
63	2 - 4 - 6 - 8	6202 2Z	6202 2Z	It doesn't need lubrication
71	2 - 4 - 6 - 8	6202 2Z	6202 2Z	It doesn't need lubrication
80	2 - 4 - 6 - 8	6204 2Z	6204 2Z	It doesn't need lubrication
90	2 - 4 - 6 - 8	6205 2Z	6205 2Z	It doesn't need lubrication
100	2 - 4 - 6 - 8	6206 2Z	6206 2Z	It doesn't need lubrication
112	2 - 4 - 6 - 8	6306 2Z	6306 2Z	It doesn't need lubrication
132	2 - 4 - 6 - 8	6308 2Z	6308 2Z	It doesn't need lubrication
160	2 - 4 - 6 - 8	6309 2Z	6309 2Z	It doesn't need lubrication

Rings for shafts

MIA and MIA1 motors can be equipped with seals to ensure a degree of protection IP66. In this way the motor is protected from ingress of dust and contaminants.

Motor		Rings	
Frame size	Poles	Front	Rear
56	2 - 4 - 6 - 8	v-ring Ø12	v-ring Ø12
63	2 - 4 - 6 - 8	v-ring Ø14	v-ring Ø14
71	2 - 4 - 6 - 8	v-ring Ø14	v-ring Ø14
80	2 - 4 - 6 - 8	v-ring Ø20	v-ring Ø20
90	2 - 4 - 6 - 8	v-ring Ø25	v-ring Ø25
100	2 - 4 - 6 - 8	v-ring Ø30	v-ring Ø30
112	2 - 4 - 6 - 8	v-ring Ø30	v-ring Ø30
132	2 - 4 - 6 - 8	v-ring Ø40	v-ring Ø40
160	2 - 4 - 6 - 8	v-ring Ø45	v-ring Ø45

5.3 RADIAL FORCE PERMISSIBLE AT THE SHAFT END

The table below shows the permissible radial load (F_R) position in the $L / 2$, assuming the engine operating at 50 Hz and a working life of the bearings of at least 20,000 hours for 2-pole motors and engines 40,000 hours for 4 - 6-8 poles.
For operation 60Hz these values should be reduced by 10%. For double speed motors take as a reference the highest speed

Considering the load F_R applied in the X position equal to $L / 2$ we have the load limit values shown in the table:

Motor	Bearing type		C Dynamic load (N)	F_R in $X=L/2$ (N)			
	Front	Rear		2 poles	4 poles	6 poles	8 poles
56	6201-ZZ	6201-ZZ	6950	317	317	-	-
63	6202-ZZ	6202-ZZ	7800	356	356	408	449
71	6202-ZZ	6202-ZZ	7800	356	356	408	449
80	6204-ZZ	6204-ZZ	12700	580	580	664	731
90	6205-ZZ	6205-ZZ	14000	639	639	732	806
100	6206-ZZ	6206-ZZ	19300	881	881	1009	1111
112	6306-ZZ	6306-ZZ	29000	1325	1325	1516	1669
132	6308-ZZ	6308-ZZ	42500	1941	1941	2222	2446
160	6309-ZZ	6309-ZZ	53000	2421	2421	2771	3050

5.1.2 Axial forces permissible on the shaft

The table below shows the maximum axial loads (F_A) Permitted on the motor bearings, these values are provided from the bearing manufacturers and learned through experience. The value is about 2% of the dynamic load of the bearing indicated in the above table.

Motor	F_A (N)
56	139
63	156
71	156
80	254
90	280
100	386
112	580
132	850
160	1000

For applications with pulley and belt the maximum radial load F_r is given by

P = weight of the pulley [N]

F = tension of the belt [N] = $(2 \cdot K \cdot M) / D$ where

K = factor for belt tension belt ($K = 3$ for flat belt without belt tensioner, $K = 2.2$ ver V-belt, flat belt for $K = 2$)

D = diameter of pulley [m]

M = torque [Nm] = $9550 P / n$ where

P = shaft power [kW]

n = rotational speed [rpm]

6 ELECTRICAL DATA

6.1 General information

In case the motors are driven by **INVERTER** we have to point out some things:

- Motor must be equipped with PTC thermistor.
- Motor driven by inverter means not to have a perfect voltage and current sine wave with increase of losses and heating of the motor.
- Speed variation affects also the ventilation (in case of IC411).
- The stress on the bearings increases and they shall be checked more frequently; for this reason the operating period with a speed above 3600 rpm shall never exceed 10% of the complete working cycle.
- The **best connection** for motors driven by inverter is the **star connection 400V**.
- In case of **constant torque application and with frequency values above 60Hz** it is necessary to use a **delta connection**.

For all these reasons RAEL manufactures special motors for inverter duty so to minimize all the inconveniences described above.

These motors are electrically oversized so to minimize the electrical losses and also reduce the heating and are provided with thermistor PTC120°C for temperature class T4; for this reason the winding of the motor is made on a oversized stator and is fitted with phase-insulators (on request it is possible to have the version T5 with PTC90°C and T6 with PTC70°C).

All the bearings mounted on RAEL motors are produced by NSK.

A Servo-Ventilated (IC416) version must be certified.

6.2 Three phase 1 speed motors

In this paragraph we will show the rating of the 1 speed 3-phase motors and the rating of the motors for inverter duty.

The values of power and current reported in the tables relating to special motors for inverter are indicative and have meaning only in the case where the inverter used is of excellent quality and high performance.

The following pages show the data for electric motors with increased safety Ex e (TUV certified IT 12ATEX 068X)

The electrical data for Ex nA motors (TUV EN 12 ATEX 069X) appear to be the same as shown in the following pages and referred to the increased safety Ex e motors.

The features of three phase motors for general purpose are as follow:

- Three phase asynchronous motor, squirrel cage rotor, self ventilated (IC411).
- Duty S1, Insulation class "F", IP55, 400V - 50 Hz.

- Connections

Type	Δ	Y
56 – 112	230 V	400V
132 – 160	400 V	690 V
56-160 for INVERTER	230 V	400 V

**1 speed 3000****Rated data at 400V/50Hz – direct on line start****Ex e /Ex Na(cert. 069X)
Tamb -40°C/+60°C**

Part Number	Type	P		rpm min ⁻¹	I _n 400 V Amp.	I _b /I _n	η %	Cos φ	M _n Nm	M _b /M _n	m kg	Class T	Moment of inertia J 10 ⁻³ kgm ²	Certificate TUV IT 12 ATEX 068X
		kW	Hp											
MIA 0042	MIA 56 A 2	0,06	0,08	2730	0,51	4,0	67	0,4	0,2	3,5	2,6	T4	0,09	◆
MIA 0043	MIA 56 A 2	0,09	0,12	2730	0,53	4,0	67	0,5	0,3	4,0	2,8	T4	0,09	◆
MIA 0044	MIA 56 B 2	0,12	0,16	2750	0,56	4,5	70	0,7	0,35	4,0	3,2	T4	0,1	◆
MIA 0001	MIA 63 A 2	0,12	0,16	2730	0,60	3,1	50	0,80	0,4	3,3	3,3	T4	0,13	◆
MIA 0002	MIA 63 A 2	0,18	0,25	2760	0,70	3,6	60	0,80	0,6	3,8	3,5	T4	0,13	◆
MIA 0003	MIA 63 B 2	0,25	0,34	2740	1,00	4,3	52	0,85	0,9	3,5	4,4	T4	0,19	◆
MIA 0004	MIA 71 A 2	0,37	0,50	2770	1,20	4,8	70	0,80	1,3	3,0	5,6	T4	0,36	◆
MIA 0005	MIA 71 B 2	0,55	0,75	2710	1,70	3,8	62	0,85	2,1	3,0	6,1	T4	0,46	◆
MIA 0006	MIA 80 A 2	0,75	1,00	2820	2,00	5,0	70	0,88	2,6	2,4	9,1	T4	0,75	◆
MIA 0007	MIA 80 B 2	1,10	1,50	2850	2,60	5,8	76	0,88	3,8	3,0	10,2	T4	0,89	◆
MIA 0008	MIA 90 S 2	1,50	2,00	2800	3,60	5,0	74	0,86	5,2	2,9	11,7	T4	1,37	◆
MIA 0009	MIA 90 L 2	2,20	3,00	2860	5,00	5,4	74	0,85	7,5	3,0	15,0	T4	1,8	◆
MIA 0032	MIA 100 LA 2	3,00	4,00	2845	7,00	6,0	79	0,84	10,2	2,6	22,3	T4	2,8	◆
MIA 0033	MIA 112 M 2	4,00	5,50	2910	8,90	5,8	80	0,86	13,2	2,6	26,7	T4	5,2	◆
MIA0080	MIA 112 L 2	5,50	7,50	2920	12,2	6,5	84	0,85	18	2,5	32	T4	6	◆
MIA 0049	MIA 132 SA 2	5,50	7,50	2870	12,40	6,7	84	0,82	18,3	2,6	38,5	T4	10,63	◆
MIA 0050	MIA 132 SB 2	7,50	10,00	2880	15,70	6,9	85	0,90	24,7	2,9	42,2	T4	13,83	◆
MIA 0051	MIA 132 MB 2	9,00	12,00	2930	18,50	6,9	87	0,89	30,5	2,9	51,4	T4	17,13	◆
MIA 0052	MIA 132 ML 2	11,00	15,00	2930	22,00	6,8	89	0,89	36	2,8	58,8	T4	17,13	◆
MIA 0053	MIA 160 MA 2	11,00	15,00	2915	23,50	7,9	82	0,89	36	2,8	101,0	T4	40,00	◆
MIA 0054	MIA 160 MB 2	15,00	20,00	2910	30,00	8,4	84	0,91	49	3,1	111,0	T4	51,75	◆
MIA 0055	MIA 160 L 2	18,50	25,00	2925	36,30	8,0	87	0,90	60	3,1	126,0	T4	64,00	◆

1 speed 3000**Motors for INVERTER – Rated data at 400V/50Hz****Ex e /Ex Na(cert. 069X)
Tamb -40°C/+60°C**

Part number	Cooling	Self ventilated - (IC411)										Forced Ventilation- (IC416)						Certificate
		Torque Range Hz speed	Quadratic			Constant			Constant			Constant			Constant			
			5 - 50 Hz			5 - 50 Hz			5 - 87 Hz			5 - 50 Hz			5 - 87 Hz			
			300 - 3000 rpm			300 - 3000 rpm			300 - 5220 rpm			300 - 3000 rpm			300 - 5220 rpm			
Type	P (kW)	P _n (kW)	M _n (Nm)	I _n (A)	P _n (kW)	M _n (Nm)	I _n (A)	P _n (kW)	M _n (Nm)	I _n (A)	P _n (kW)	M _n (Nm)	I _n (A)	P _n (kW)	M _n (Nm)	I _n (A)		
MIA0642-I	MIA 56 A 2	0,06	0,06	0,20	0,51	0,05	0,15	0,28	0,04	0,12	0,22	-	-	-	-	-	-	◆
MIA0643-I	MIA 56 A 2	0,09	0,09	0,30	0,53	0,07	0,23	0,37	0,05	0,18	0,30	-	-	-	-	-	-	◆
MIA0644-I	MIA 56 B 2	0,12	0,12	0,35	0,56	0,09	0,26	0,38	0,07	0,21	0,30	-	-	-	-	-	-	◆
MIA0601-I	MIA 63 A 2	0,12	0,12	0,40	0,60	0,09	0,30	0,45	0,07	0,24	0,36	0,11	0,36	0,54	0,10	0,32	0,48	◆
MIA0602-I	MIA 63 A 2	0,18	0,18	0,60	0,75	0,14	0,45	0,57	0,11	0,36	0,45	0,16	0,54	0,68	0,14	0,48	0,60	◆
MIA0603-I	MIA 63 B 2	0,25	0,25	0,90	1,20	0,19	0,68	0,90	0,15	0,54	0,72	0,23	0,81	1,08	0,20	0,72	0,96	◆
MIA0604-I	MIA 71 A 2	0,37	0,37	1,30	1,20	0,28	0,98	0,90	0,22	0,78	0,72	0,33	1,17	1,08	0,30	1,04	0,96	◆
MIA0605-I	MIA 71 B 2	0,55	0,55	2,10	1,80	0,41	1,58	1,36	0,33	1,26	1,08	0,50	1,89	1,62	0,44	1,68	1,44	◆
MIA0606-I	MIA 80 A 2	0,75	0,75	2,60	2,16	0,56	1,95	1,62	0,45	1,56	1,30	0,68	2,34	1,94	0,60	2,08	1,73	◆
MIA0607-I	MIA 80 B 2	1,10	1,10	3,80	2,64	0,83	2,85	1,98	0,66	2,28	1,58	0,99	3,42	2,38	0,88	3,04	2,11	◆
MIA0608-I	MIA 90 S 2	1,50	1,50	5,20	3,74	1,13	3,90	2,81	0,90	3,12	2,24	1,35	4,68	3,37	1,20	4,16	2,99	◆
MIA0609-I	MIA 90 LA 2	2,20	2,20	7,50	5,28	1,65	5,63	3,96	1,32	4,50	3,17	1,98	6,75	4,75	1,76	6,00	4,22	◆
MIA0632-I	MIA 100 LA 2	3,00	3,00	10,20	7,15	2,25	7,65	5,37	1,80	6,12	4,29	2,70	9,18	6,44	2,40	8,16	5,72	◆
MIA0633-I	MIA 112 M 2	4,00	4,00	13,20	9,24	3,00	9,90	6,93	2,40	7,92	5,54	3,60	11,88	8,32	3,20	10,56	7,39	◆
MIA0649-I	MIA 132 SA 2	5,50	5,50	18,30	12,54	4,13	13,73	9,41	3,30	10,98	7,52	4,95	16,47	11,29	4,40	14,64	10,03	◆
MIA0650-I	MIA 132 SB 2	7,50	7,50	24,70	15,40	5,63	18,53	11,55	4,50	14,82	9,24	6,75	22,23	13,86	6,00	19,76	12,32	◆
MIA0651-I	MIA 132 MB 2	9,00	9,00	30,50	18,48	6,75	22,88	13,86	5,40	18,30	11,09	8,10	27,45	16,63	7,20	24,40	14,78	◆
MIA0652-I	MIA 132 ML 2	11,00	11,00	36,00	22,22	8,25	27,00	16,67	6,60	21,60	13,33	9,90	32,40	20,00	8,80	28,80	17,78	◆
MIA0653-I	MIA 160 MA 2	11,00	11,00	36,00	24,20	8,25	27,00	18,15	6,60	21,60	14,52	9,90	32,40	21,78	8,80	28,80	19,36	◆
MIA0654-I	MIA 160 MB 2	15,00	15,00	49,00	31,13	11,25	36,75	23,35	9,00	29,40	18,68	13,50	44,10	28,02	12,00	39,20	24,90	◆
MIA0655-I	MIA 160 L 2	18,50	18,50	60,00	37,40	13,88	45,00	28,05	11,10	36,00	22,44	16,65	54,00	33,66	14,80	48,00	29,92	◆

**1 Speed 1500****Rated data at 400V/50Hz – direct on line start****Ex e /Ex Na(cert. 069X)
Tamb -40°C/+60°C**

Part number	Type			P		rpm min ⁻¹	I _n		I _a /I _n	η %	Cos φ	M _n Nm	M _a /M _n	m kg	Class T	Moment of inertia		Certificate TUV IT 12 ATEX 068X
				kW	Hp		400 V Amp.	J 10 ⁻³ kgm ²										
MIA 0045	MIA	56	A 4	0,06	0,08	1360	0,40	3,5	64	0,68	0,4	4,0	3,0	T4	0,14	◆		
MIA 0046	MIA	56	B 4	0,09	0,12	1360	0,45	3,0	67	0,67	0,6	3,5	3,3	T4	0,14	◆		
MIA 0010	MIA	63	A 4	0,12	0,16	1400	0,74	3,3	51	0,60	0,9	3,0	3,5	T4	0,25	◆		
MIA 0011	MIA	63	B 4	0,18	0,25	1400	0,84	3,5	65	0,63	1,3	2,2	4,3	T4	0,27	◆		
MIA 0012	MIA	71	A 4	0,25	0,34	1370	1,20	3,0	50	0,73	1,8	2,2	5,4	T4	0,63	◆		
MIA 0013	MIA	71	B 4	0,37	0,50	1370	1,50	3,4	57	0,74	2,6	2,4	6,2	T4	0,76	◆		
MIA 0014	MIA	80	A 4	0,55	0,75	1410	1,70	4,4	63	0,80	3,8	2,2	7,3	T4	1,58	◆		
MIA 0015	MIA	80	B 4	0,75	1,00	1410	2,20	4,9	67	0,80	5,2	1,9	10	T4	2,00	◆		
MIA0082	MIA	80	B 4	1	1,5	1425	3,2	4,9	70	0,65	6,9	2	13	T4	2,2	◆		
MIA 0016	MIA	90	S 4	1,10	1,50	1410	3,00	4,2	73	0,77	7,7	2,3	12,1	T4	2,5	◆		
MIA 0017	MIA	90	L 4	1,50	2,00	1400	4,00	5,0	72	0,80	10,4	3,0	14,6	T4	3,13	◆		
MIA 0034	MIA	100	LA 4	2,20	3,00	1410	5,20	5,0	80	0,84	15,1	2,3	21	T4	4,05	◆		
MIA 0035	MIA	100	LB 4	3,00	4,00	1440	7,10	5,4	80	0,81	20,1	2,6	24,7	T4	5,58	◆		
MIA 0036	MIA	112	M 4	4,00	5,50	1450	9,10	6,0	84	0,82	26,8	2,7	30,5	T4	12,2	◆		
MIA 0081	MIA	112	L 4	5,50	7,50	1440	11,9	5,7	85	0,8	36,3	2,5	32	T4	14,2	◆		
MIA 0056	MIA	132	SB 4	5,50	7,50	1440	12,00	6,1	85	0,82	36,0	2,4	34,8	T4	22,4	◆		
MIA 0057	MIA	132	MB 4	7,50	10,00	1448	16,30	6,6	87	0,84	49,5	2,4	46,9	T4	29,25	◆		
MIA 0058	MIA	132	ML 4	9,00	12,00	1460	19,50	6,7	84	0,86	58,0	2,5	56,6	T4	37,25	◆		
MIA 0059	MIA	160	MB 4	11,00	15,00	1460	23,80	5,5	88	0,85	72,0	2,6	109,0	T4	81,25	◆		
MIA 0060	MIA	160	L 4	15,00	20,00	1450	30,60	5,8	87	0,83	97,1	2,6	130,0	T4	105,75	◆		

1 Speed 1500**Motors for INVERTER – Rated data at 400V/50Hz****Ex e /Ex Na(cert. 069X)
Tamb -40°C/+60°C**

Part number	Type	Cooling		Self ventilated - (IC411)									Forced ventiation - (IC416)						Certificate
		Torque		Quadratic			Constant			Constant			Constant			Constant			
		Range Hz		5 - 50 Hz			5 - 50 Hz			5 - 87 Hz			5 - 50 Hz			5 - 87 Hz			
		Speed		150 - 1500 rpm			150 - 1500 rpm			150 - 2600 rpm			150 - 1500 rpm			150 - 2600 rpm			
		P	P _n	M _n	I _n	P _n	M _n	I _n	P _n	M _n	I _n	P _n	M _n	I _n	P _n	M _n	I _n	P _n	
(kW)	(kW)	(Nm)	(A)	(kW)	(Nm)	(A)	(kW)	(Nm)	(A)	(kW)	(Nm)	(A)	(kW)	(Nm)	(A)	(kW)	(Nm)	(A)	
MIA 0645-I	MIA 56 A 4	0,06	0,06	0,40	0,37	0,05	0,30	0,28	0,04	0,24	0,22	-	-	-	-	-	-	-	◆
MIA 0646-I	MIA 56 B 4	0,09	0,09	0,60	0,56	0,07	0,45	0,43	0,05	0,36	0,33	-	-	-	-	-	-	-	◆
MIA 0610-I	MIA 63 A 4	0,12	0,12	0,90	0,81	0,09	0,68	0,45	0,07	0,54	0,34	0,11	0,81	0,51	0,10	0,72	0,51	◆	
MIA 0611-I	MIA 63 B 4	0,18	0,18	1,30	0,96	0,14	0,98	0,45	0,11	0,78	0,45	0,16	1,17	0,60	0,14	1,04	0,60	◆	
MIA 0612-I	MIA 71 A 4	0,25	0,25	1,80	1,50	0,19	1,35	1,13	0,15	1,08	0,90	0,23	1,62	1,35	0,20	1,44	1,20	◆	
MIA 0613-I	MIA 71 B 4	0,37	0,37	2,60	1,95	0,28	1,95	1,47	0,22	1,56	1,17	0,33	2,34	1,76	0,30	2,08	1,56	◆	
MIA 0614-I	MIA 80 A 4	0,55	0,55	3,80	1,80	0,41	2,85	1,36	0,33	2,28	1,08	0,50	3,42	1,62	0,44	3,04	1,44	◆	
MIA 0615-I	MIA 80 B 4	0,75	0,75	5,20	2,40	0,56	3,90	1,80	0,45	3,12	1,44	0,68	4,68	2,16	0,60	4,16	1,92	◆	
MIA 0616-I	MIA 90 S 4	1,10	1,10	7,70	3,36	0,83	5,78	2,52	0,66	4,62	2,02	0,99	6,93	3,02	0,88	6,16	2,69	◆	
MIA 0617-I	MIA 90 L 4	1,50	1,50	10,40	4,18	1,13	7,80	3,14	0,90	6,24	2,51	1,35	9,36	3,76	1,20	8,32	3,34	◆	
MIA 0634-I	MIA 100 LA 4	2,20	2,20	15,10	5,28	1,65	11,33	3,96	1,32	9,06	3,17	1,98	13,59	4,75	1,76	12,08	4,22	◆	
MIA 0635-I	MIA 100 LB 4	3,00	3,00	20,10	7,26	2,25	15,08	5,45	1,80	12,06	4,36	2,70	18,09	6,53	2,40	16,08	5,81	◆	
MIA 0636-I	MIA 112 M 4	4,00	4,00	26,80	9,46	3,00	20,10	7,10	2,40	16,08	5,68	3,60	24,12	8,51	3,20	21,44	7,57	◆	
MIA 0656-I	MIA 132 SB 4	5,50	5,50	36,00	12,54	4,13	27,00	9,41	3,30	21,60	7,52	4,95	32,40	11,29	4,40	28,80	10,03	◆	
MIA 0657-I	MIA 132 MB 4	7,50	7,50	49,50	16,28	5,63	37,13	12,21	4,50	29,70	9,77	6,75	44,55	14,65	6,00	39,60	13,02	◆	
MIA 0658-I	MIA 132 ML 4	9,00	9,00	58,00	19,69	6,75	43,50	14,77	5,40	34,80	11,81	8,10	52,20	17,72	7,20	46,40	15,75	◆	
MIA 0659-I	MIA 160 MB 4	11,00	11,00	72,00	23,43	8,25	54,00	17,58	6,60	43,20	14,06	9,90	64,80	21,09	8,80	57,60	18,74	◆	
MIA 0660-I	MIA 160 L 4	15,00	15,00	97,10	30,80	11,25	72,83	23,10	9,00	58,26	18,48	13,50	87,39	27,72	12,00	77,68	24,64	◆	

**1 Speed 1000****Rated data at 400V/50Hz – direct on line start****Ex e /Ex Na(cert. 069X)
Tamb -40°C/+60° c**

Part number	Type	P		rpm min ⁻¹	In 400 V Amp.	I _a /I _n %	η φ	Cos Nm	M _n	M _a /M _n	m kg	Class T	Moment of inertia J 10 ⁻³ kgm ²	Certificate TUV IT 12 ATEX 068X
		kW	Hp											
MIA 0019	MIA 71 A 6	0,18	0,25	900	1.00	2.8	46	0.70	2,0	2.4	6.0	T4	0.6	◆
MIA 0020	MIA 71 B 6	0,25	0,34	910	1.40	2.9	50	0.60	2,7	3.1	6.5	T4	0.9	◆
MIA 0021	MIA 80 A 6	0,37	0,50	935	1.60	3.9	62	0.65	3,8	2.6	7.2	T4	1.97	◆
MIA 0022	MIA 80 B 6	0,55	0,75	930	2.00	3.5	64	0.70	5,8	2.8	9.9	T4	2.47	◆
MIA 0023	MIA 90 S 6	0,75	1,00	930	2.40	3.5	71	0.70	7,9	2.3	11.7	T4	3.18	◆
MIA 0024	MIA 90 L 6	1,10	1,50	910	3.40	3.7	67	0.75	11,6	2.3	15.1	T4	4.78	◆
MIA 0037	MIA 100 LB 6	1,50	2,00	940	4.40	3.8	80	0.75	15,2	1.7	19.1	T4	6.73	◆
MIA 0038	MIA 112 M 6	2,20	3,00	940	5.40	4.7	82	0.80	22,4	1.8	25.4	T4	14.18	◆
MIA 0061	MIA 132 SB 6	3,00	4,00	945	8.50	4.5	86	0.75	30,3	1.7	36.1	T4	23.53	◆
MIA 0062	MIA 132 MB 6	4,00	5,50	950	10.90	4.5	82	0.77	39,0	1.8	45.0	T4	29.50	◆
MIA 0063	MIA 132 ML 6	5,50	7,50	950	14.00	4.6	81	0.80	55,0	1.8	55.5	T4	37.75	◆
MIA 0064	MIA 160 MB 6	7,50	10,00	965	16.40	4.5	85	0.86	75,6	1.8	60.0	T4	81.25	◆
MIA 0065	MIA 160 L 6	11,00	15,00	955	23.30	4.6	85	0.86	110,0	1.8	121.0	T4	105.75	◆

1 Speed 1000**Motors for INVERTER – Rated data at 400V/50Hz****Ex e /Ex Na(cert. 069X)
Tamb -40°C/+60°C**

Part number	Type	Cooling		Self ventilated - (IC411)									Forced ventilation - (IC416)						Certificate
		Torque		Quadratic			Constant			Constant			Constant			Constant			
		Range Hz		5 - 50 Hz			5 - 50 Hz			5 - 87 Hz			5 - 50 Hz			5 - 87 Hz			
		Speed		150 - 1500 rpm			150 - 1500 rpm			150 - 2600 rpm			150 - 1500 rpm			150 - 2600 rpm			
		P	P _n	M _n	I _n	P _n	M _n	I _n	P _n	M _n	I _n	P _n	M _n	I _n	P _n	M _n	I _n	P _n	
(kW)	(kW)	(Nm)	(A)	(kW)	(Nm)	(A)	(kW)	(Nm)	(A)	(kW)	(Nm)	(A)	(kW)	(Nm)	(A)	(kW)	(Nm)	(A)	
MIA 0619-I	MIA 71 A 6	0,18	0,18	2,00	1,48	0,14	1,50	1,11	0,11	1,20	0,48	0,16	1,80	1,33	0,14	1,60	0,64	◆	
MIA 0620-I	MIA 71 B 6	0,25	0,25	2,70	2,04	0,19	2,03	1,53	0,15	1,62	0,72	0,23	2,43	1,84	0,20	2,16	0,96	◆	
MIA 0621-I	MIA 80 A 6	0,37	0,37	3,80	2,10	0,28	2,85	1,58	0,22	2,28	0,84	0,33	3,42	1,89	0,30	3,04	1,12	◆	
MIA 0622-I	MIA 80 B 6	0,55	0,55	5,80	2,70	0,41	4,35	2,03	0,33	3,48	1,08	0,50	5,22	2,43	0,44	4,64	1,44	◆	
MIA 0623-I	MIA 90 S 6	0,75	0,75	7,90	3,30	0,56	5,93	2,48	0,45	4,74	1,32	0,68	7,11	2,97	0,60	6,32	1,76	◆	
MIA 0624-I	MIA 90 L 6	1,10	1,10	11,60	3,84	0,83	8,70	2,88	0,66	6,96	1,92	0,99	10,44	3,46	0,88	9,28	2,56	◆	
MIA 0637-I	MIA 100 LB 6	1,50	1,50	15,20	4,68	1,13	11,40	3,60	0,90	9,12	2,46	1,35	13,68	4,25	1,20	12,16	3,98	◆	
MIA 0638-I	MIA 112 M 6	2,20	2,20	22,40	5,88	1,65	16,80	4,42	1,32	13,44	2,94	1,98	20,16	5,29	1,76	17,92	3,92	◆	
MIA 0661-I	MIA 132 SB 6	3,00	3,00	30,30	7,37	2,25	22,73	5,53	1,80	18,18	4,02	2,70	27,27	6,63	2,40	24,24	5,36	◆	
MIA 0662-I	MIA 132 MB 6	4,00	4,00	39,00	10,01	3,00	29,25	7,51	2,40	23,40	5,46	3,60	35,10	9,01	3,20	31,20	7,28	◆	
MIA 0663-I	MIA 132 ML 6	5,50	5,50	55,00	13,53	4,13	41,25	10,15	3,30	33,00	7,38	4,95	49,50	12,18	4,40	44,00	9,84	◆	
MIA 0664-I	MIA 160 MB 6	7,50	7,50	75,60	16,28	5,63	56,70	12,21	4,50	45,36	8,88	6,75	68,04	14,65	6,00	60,48	11,84	◆	
MIA 0665-I	MIA 160 L 6	11,00	11,00	110,0	23,76	8,25	82,50	17,82	6,60	66,00	12,96	9,90	99,00	21,38	8,80	88,00	17,28	◆	

- ◆ Certificate TUV IT12 ATEX 068X FOR MOTORS Ex e
- ◆ Certificate TUV IT12 ATEX 069X FOR MOTORS Ex nA

**1 Speed 750****Rated data at 400V/50Hz – direct on line start****Ex e /Ex Na(cert. 069X)
Tamb -40°C/+60° C**

Part number	Type	P kW	P Hp	rpm min ⁻¹	In 400 V Amp.	Ia/In %	η %	Cos Nm	M _n	M _a /M _n	m kg	Class T	Moment of inertia J 10 ⁻³ kgm ²	□ Certificate TUV IT 12 ATEX 068X
MIA 0026	MIA 71 A 8	0,09	0,12	660	0.75	2.2	38	0.63	1,3	2.7	6,0	T4	0.90	◆
MIA 0027	MIA 71 B 8	0,12	0,16	640	0.85	2.0	39	0.7	1.8	2.3	6,8	T4	0.90	◆
MIA 0028	MIA 80 A 8	0,18	0,25	690	1.15	2.8	49	0.6	2,5	2.7	9,9	T4	1.2	◆
MIA 0029	MIA 80 B 8	0,25	0,34	700	1.40	2.9	55	0.55	3,6	2.8	10,9	T4	1.97	◆
MIA 0030	MIA 90 S 8	0,37	0,50	680	1.50	3.0	60	0.67	5,2	1.6	14,8	T4	3.18	◆
MIA 0031	MIA 90 L 8	0,55	0,75	690	2.10	3.0	65	0.65	7,7	2.4	17,2	T4	4.78	◆
MIA 0039	MIA 100 LA 8	0,75	1,00	700	3.10	3.4	65	0,65	10,0	2.3	17,5	T4	6.72	◆
MIA 0040	MIA 100 LB 8	1,10	1,50	700	4.10	3.7	63	0,69	15,2	2.2	19,7	T4	15.93	◆
MIA 0041	MIA 112 M 8	1,50	2,00	705	4.80	4.1	79	0,64	20,2	1.9	25,6	T4	16.70	◆
MIA 0066	MIA 132 SB 8	2,20	3,00	705	6.90	3.8	82	0,75	30,2	1.8	35,5	T4	29.50	◆
MIA 0067	MIA 132 MB 8	3,00	4,00	715	8.65	4.0	84	0,74	40,0	1.9	45,0	T4	37.75	◆
MIA 0068	MIA 160 MA 8	4,00	5,50	710	11.20	4.1	82	0,78	52,0	1.9	90,0	T4	89.50	◆
MIA 0069	MIA 160 MB 8	5,50	7,50	715	14.40	4.0	86	0,76	72,5	2.1	102,0	T4	119.50	◆
MIA 0070	MIA 160 L 8	7,50	10,00	720	17.60	4.2	86	0,79	99,8	2.3	122,0	T4	150.25	◆

1 Speed 750**Motors for INVERTER – Rated data at 400V/50Hz****Ex e /Ex Na(cert. 069X)
Tamb -40°C/+60° C**

Part number	Type	Cooling		Self ventilated - (IC411)									Forced ventilation - (IC416)						Certificate
		Torque		Quadratic			Constant			Constant			Constant			Constant			
		Range Hz		5 - 50 Hz			5 - 50 Hz			5 - 87 Hz			5 - 50 Hz			5 - 87 Hz			
		Speed		150 - 1500 rpm			150 - 1500 rpm			150 - 2600 rpm			150 - 1500 rpm			150 - 2600 rpm			
		P (kW)	P _n (kW)	M _n (Nm)	I _n (A)	P _n (kW)	M _n (Nm)	I _n (A)	P _n (kW)	M _n (Nm)	I _n (A)	P _n (kW)	M _n (Nm)	I _n (A)	P _n (kW)	M _n (Nm)	I _n (A)		
MIA 0626-I	MIA 71 A 8	0,09	0,09	1,30	1,02	0,07	0,98	0,76	0,05	0,78	0,330	0,08	1,17	0,93	0,07	1,04	0,44	◆	
MIA 0627-I	MIA 71 B 8	0,12	0,12	1,80	1,11	0,09	1,35	0,83	0,07	1,08	0,39	0,11	1,62	1,00	0,10	1,44	0,52	◆	
MIA 0628-I	MIA 80 A 8	0,18	0,18	2,50	1,43	0,14	1,88	1,07	0,11	1,50	0,57	0,16	2,25	1,29	0,14	2,00	0,76	◆	
MIA 0629-I	MIA 80 B 8	0,25	0,25	3,60	1,80	0,19	2,70	1,35	0,15	2,16	0,72	0,23	3,24	1,62	0,20	2,88	0,96	◆	
MIA 0630-I	MIA 90 S 8	0,37	0,37	5,20	1,95	0,28	3,90	1,47	0,22	3,12	0,78	0,33	4,68	1,76	0,30	4,16	1,04	◆	
MIA 0631-I	MIA 90 L 8	0,55	0,55	7,70	2,28	0,41	5,78	1,72	0,33	4,62	1,14	0,50	6,93	2,05	0,44	6,16	1,52	◆	
MIA 0639-I	MIA 100 LA 8	0,75	0,75	10,00	3,12	0,56	7,50	2,34	0,45	6,00	1,56	0,68	9,00	2,81	0,60	8,00	2,08	◆	
MIA 0640-I	MIA 100 LB 8	1,10	1,10	15,20	4,32	0,83	11,70	3,30	0,66	9,36	2,30	0,99	14,04	3,84	0,88	12,48	2,90	◆	
MIA 0641-I	MIA 112 M 8	1,50	1,50	20,20	4,73	1,13	15,15	3,55	0,90	12,12	2,58	1,35	18,18	4,26	1,20	16,16	3,44	◆	
MIA 0666-I	MIA 132 SB 8	2,20	2,20	30,20	5,72	1,65	22,65	4,29	1,32	18,12	3,12	1,98	27,18	5,15	1,76	24,16	4,16	◆	
MIA 0667-I	MIA 132 MB 8	3,00	3,00	40,00	7,70	2,25	30,00	5,78	1,80	24,00	4,20	2,70	36,00	6,93	2,40	32,00	5,60	◆	
MIA 0668-I	MIA 160 MA 8	4,00	4,00	52,00	9,90	3,00	39,00	7,43	2,40	31,20	5,40	3,60	46,80	8,91	3,20	41,60	7,20	◆	
MIA 0669-I	MIA 160 MB 8	5,50	5,50	72,50	13,97	4,13	54,38	10,48	3,30	43,50	7,62	4,95	65,25	12,57	4,40	58,00	10,16	◆	
MIA 0670-I	MIA 160 L 8	7,50	7,50	99,80	17,49	5,63	74,85	13,12	4,50	59,88	9,54	6,75	89,82	15,74	6,00	79,84	12,72	◆	

- ◆ Certificate TUV IT12 ATEX 068X FOR MOTORS Ex e
- ◆ Certificate TUV IT12 ATEX 069X FOR MOTORS Ex nA



6.3 Three phase 2 speed motors Constant Torque (For general purpose)

- Three phase asynchronous motor, squirrel cage rotor, self ventilated (IC411).
- Duty S1, Insulation class "F", IP55, 400V- 50 Hz.

- Connections

Poles	Connection	High Speed	Low Speed
2/4 – 4/8	(Dahlander)	YY 400 V	Δ 400V
4/6 – 6/8	(2 Separate windings)	Y 400 V	Y 400V

2 Speed 3000/1500

CONSTANT TORQUE – Rated data at 400V/50Hz

Ex e /Ex Na(cert. 069X)
Tamb -40°C/+60°C

Part number	Type	P kW	rpm min ⁻¹	In 400 V Amp.	Ia/In	η %	Cos ϕ	M _n Nm	M _a /M	m Kg	Class T	Moment of inertia J 10 ⁻³ kgm ²	◆ Certificate TUV IT 12 ATEX 068X
MIA 4002	MIA 2CT 71 A 2/4	0,30	2800	1,35	3,2	53	0,71	1,1	1,7	7,5	T4	0.6	◆
		0,20	1400	1,05	3,0	57	0,66	1,4	1,5				◆
MIA 4003	MIA 2CT 71 B 2/4	0,45	2805	1,72	3,8	60	0,70	1,6	1,8	9,8	T4	0.9	◆
		0,30	1400	1,20	3,6	68	0,62	2,1	1,8				◆
MIA 4004	MIA 2CT 80 A 2/4	0,55	2820	1,90	4,1	67	0,76	1,9	1,7	10,0	T4	0.9	◆
		0,37	1390	1,70	3,9	68	0,625	2,6	1,7				◆
MIA 4005	MIA 2CT 80 B 2/4	0,75	2830	2,30	4,4	72	0,81	2,6	1,8	12,0	T4	1.3	◆
		0,55	1400	2,10	4,1	67	0,71	3,9	1,8				◆
MIA 4006	MIA 2CT 90 S 2/4	1,25	2830	3,20	5,4	73	0,82	4,4	2,1	16,5	T4	2.0	◆
		0,90	1405	2,80	4,6	69	0,72	6,4	1,9				◆
MIA 4007	MIA 2CT 90 L 2/4	1,60	2820	4,20	4,4	70	0,81	5,6	2,1	17,6	T4	2.6	◆
		1,20	1405	3,50	4,3	69	0,76	8,5	2,0				◆
MIA 4008	MIA 2CT 100 LA 2/4	2,35	2820	5,40	6,4	77	0,85	8,3	2,4	23,2	T4	4.3	◆
		1,85	1420	4,60	5,5	75	0,79	13,0	2,1				◆
MIA 4009	MIA 2CT 100 LB 2/4	3,00	2840	6,95	7,0	77	0,84	10,5	2,2	25,0	T4	5.3	◆
		2,40	1425	5,35	6,1	77	0,85	16,8	2,0				◆
MIA 4010	MIA 2CT 112 M 2/4	4,00	2890	9,00	7,1	77	0,88	13,8	2,2	35,0	T4	10.3	◆
		3,30	1430	7,50	6,2	78	0,87	23,0	2,2				◆
MIA 4036	MIA 2CT 132 S 2/4	5,90	2850	13,00	7,1	84	0,85	19,5	2,2	60,2	T4	15.0	◆
		4,80	1440	10,40	6,3	85	0,87	32,0	2,1				◆
MIA 4037	MIA 2CT 132 MB 2/4	7,50	2880	14,80	7,3	87	0,91	25,0	2,1	66,0	T4	17.8	◆
		5,50	1450	12,00	6,5	87	0,84	44,0	2,1				◆
MIA 4038	MIA 2CT 132 L 2/4	8,00	2930	15,9	7,4	87	0,89	30,5	2,2	70,5	T4	21.6	◆
		6,00	1460	13,00	6,2	85	0,86	50,0	2,1				◆
MIA 4039	MIA 2CT 160 M 2/4	11,00	2915	23,00	7,2	82	0,89	36,0	2,2	105,0	T4	62.7	◆
		8,80	1460	18,00	6,4	88	0,85	58,5	2,2				◆
MIA 4040	MIA 2CT 160 L 2/4	15,00	2910	29,30	7,4	84	0,91	49,0	2,5	115,0	T4	80.1	◆
		12,00	1450	24,70	6,5	87	0,84	79,0	2,4				◆

- ◆ Certificate TUV IT12 ATEX 068X FOR MOTORS Ex e
- ◆ Certificate TUV IT12 ATEX 069X FOR MOTORS Ex nA

**2 Speed 1500/750 CONSTANT TORQUE – rated data at 400V/50Hz****Ex e /Ex Na(cert. 069X)
Tamb -40°C/+60°C**

Part number	Type	P kW	rpm min ⁻¹	In 400 V Amp.	I _a /I _n	η %	Cos φ	M _n Nm	M _a /M	m Kg	Class T	Moment of inertia J 10 ⁻³ kgm ²	◆ Certificate TUV IT 12 ATEX 068X
MIA 4011	MIA 2CT 71 A 4/8	0,18	1380	0,82	3,5	68	0,62	1,3	2,2	5,8	T4	0.7	◆
		0,09	660	0,65	2,2	40	0,72	1,4	2,7				
MIA 4012	MIA 2CT 71 B 4/8	0,25	1380	0,88	3,0	70	0,75	1,5	2,2	7,2	T4	1.0	◆
		0,12	660	0,78	2,0	42	0,71	1,5	2,3				
MIA 4013	MIA 2CT 80 A 4/8	0,37	1400	1,20	3,4	71	0,75	2,2	2,4	9,0	T4	2.2	◆
		0,18	670	0,97	2,8	50	0,67	2,3	2,7				
MIA 4014	MIA 2CT 80 B 4/8	0,55	1400	1,63	4,4	75	0,74	3,1	2,2	10,8	T4	2.7	◆
		0,25	670	2,17	2,9	54	0,69	2,9	2,8				
MIA 4015	MIA 2CT 90 S 4/8	0,75	1405	2,05	4,9	71	0,77	4,5	1,9	14,4	T4	3.4	◆
		0,37	675	1,43	3,0	62	0,70	4,4	1,6				
MIA 4016	MIA 2CT 90 L 4/8	1,00	1405	2,70	4,2	77	0,75	6,9	2,3	16,2	T4	4.9	◆
		0,55	675	1,90	3,0	67	0,70	6,8	2,4				
MIA 4017	MIA 2CT 100 LA 4/8	1,30	1420	3,70	4,5	79	0,77	9,1	3,0	20,7	T4	8.8	◆
		0,70	700	2,60	4,9	70	0,68	8,9	1,9				
MIA 4018	MIA 2CT 100 LB 4/8	1,80	1430	4,50	5,0	80	0,81	11,5	2,5	22,5	T4	8.8	◆
		0,90	690	3,10	3,7	72	0,74	12,0	1,8				
MIA 4019	MIA 2CT 112 M 4/8	2,50	1450	5,50	5,5	81	0,85	17,2	2,1	31,5	T4	17.2	◆
		1,25	705	4,20	4,1	78	0,65	16,9	1,9				
MIA 4041	MIA 2CT 132 S 4/8	3,30	1445	7,80	4,9	83	0,85	22,0	1,6	50,4	T4	32.3	◆
		1,85	705	5,40	4,1	82	0,75	25,0	1,6				
MIA 4042	MIA 2CT 132 MB 4/8	4,80	1430	11,00	5,2	85	0,82	32,0	1,7	54,9	T4	50.6	◆
		2,40	710	6,55	4,3	82	0,76	33,0	1,7				
MIA 4043	MIA 2CT 132 L 4/8	5,50	1440	12,40	5,5	85	0,82	36,0	1,8	63,9	T4	50.6	◆
		3,00	715	8,00	4,5	84	0,74	39,7	1,8				
MIA 4044	MIA 2CT 160 M 4/8	7,50	1450	18,10	5,7	87	0,84	49,0	1,9	95,4	T4	91.9	◆
		4,80	715	11,70	4,7	86	0,76	63,0	1,8				
MIA 4045	MIA 2CT 160 L 4/8	10,00	1450	21,70	6,8	83	0,84	66,0	1,9	106,2	T4	12.18	◆
		6,60	720	13,80	5,6	86	0,87	88,0	1,9				

- ◆ Certificate TUV IT12 ATEX 068X FOR MOTORS Ex e
- ◆ Certificate TUV IT12 ATEX 069X FOR MOTORS Ex nA

**2 Speed 1500/1000****CONSTANT TORQUE– Rated data at 400V/50Hz****Ex e /Ex Na(cert. 069X)
Tamb -40°C/+60°C**

Part number	Type	P kW	rpm min ⁻¹	In 400 V Amp.	I _a /I _n	η %	Cos φ	M _n Nm	M _a /M	m Kg	Class T	Moment of inertia J 10 ⁻³ kgm ²	Certificate TUV IT 12 ATEX 068X
MIA 4020	MIA 2CT 71 B 4/6	0,20	1400	0,75	3,3	70	0,75	1,3	1,4	7,2	T4	1.0	◆
		0,10	900	0,58	2,4	53	0,71	1,1	1,4				
MIA 4021	MIA 2CT 80 A 4/6	0,40	1400	1,30	3,4	71	0,75	2,9	1,4	9,0	T4	2.7	◆
		0,20	905	0,85	2,5	62	0,72	2,1	1,5				
MIA 4022	MIA 2CT 80 B 4/6	0,50	1405	1,58	3,6	71	0,74	3,4	1,5	10,8	T4	2.7	◆
		0,30	910	2,10	3,1	66	0,73	3,0	1,5				
MIA 4023	MIA 2CT 90 S 4/6	0,65	1405	1,85	5,8	76	0,75	4,5	1,6	14,4	T4	3.4	◆
		0,45	910	1,46	4,3	70	0,73	4,6	1,5				
MIA 4024	MIA 2CT 90 L 4/6	0,95	1410	2,56	5,5	77	0,76	6,3	1,5	16,2	T4	4.9	◆
		0,60	910	1,86	3,6	70	0,74	6,4	1,6				
MIA 4025	MIA 2CT 100 LA 4/6	1,40	1415	3,70	5,7	81	0,73	9,4	1,8	20,7	T4	8.8	◆
		0,90	910	2,90	4,1	74	0,74	9,3	1,7				
MIA 4026	MIA 2CT 100 LB 4/6	1,85	1415	4,60	5,8	80	0,81	12,4	1,6	22,5	T4	8.8	◆
		1,10	910	3,40	3,9	74	0,74	12,1	1,6				
MIA 4027	MIA 2CT 112 M 4/6	2,40	1420	5,45	6,1	82	0,85	16,2	1,8	31,5	T4	17.2	◆
		1,60	940	4,16	4,3	81	0,77	16,5	1,7				
MIA 4046	MIA 2CT 132 S 4/6	3,00	1440	7,00	5,9	82	0,87	20,0	1,9	49,5	T4	32.3	◆
		2,00	945	5,46	3,9	81	0,80	20,2	1,6				
MIA 4047	MIA 2CT 132 MA 4/6	4,00	1450	9,40	6,1	84	0,82	26,3	2,0	54,0	T4	39.5	◆
		2,60	940	6,80	4,5	84	0,77	25,9	1,8				
MIA 4048	MIA 2CT 132 L 4/6	4,40	1445	10,00	6,3	83	0,89	29,0	1,9	59,4	T4	50.6	◆
		3,00	965	7,60	4,4	80	0,8	30,3	1,7				
MIA 4049	MIA 2CT 132 L 4/6	5,15	1450	11,70	6,8	85	0,82	33,5	1,9	63,9	T4	50.6	◆
		3,30	945	8,30	4,7	86	0,76	33,0	1,7				
MIA 4050	MIA 2CT 160 M 4/6	6,60	1460	14,40	6,8	86	0,83	43,0	1,9	95,4	T4	91.9	◆
		4,40	950	10,90	4,4	82	0,79	43,9	1,8				
MIA 4051	MIA 2CT 160 L 4/6	8,80	1460	22,21	6,8	83	0,84	57,7	1,9	106,2	T4	12.18	◆
		5,90	950	33,60	4,9	81	0,80	58,0	1,8				

- ◆ Certificate TUV IT12 ATEX 068X FOR MOTORS Ex e
- ◆ Certificate TUV IT12 ATEX 069X FOR MOTORS Ex nA

**2 Speed 1000/750****CONSTANT TORQUE – Rated data at 400V/50Hz****Ex e /Ex Na(cert. 069X)
Tamb 40 °C/+60 °C**

Part number	Type	P kW	rpm min ⁻¹	I _n 400 V Amp.	I _a /I _n	η %	Cos φ	M _n Nm	M _a /M	m Kg	Class T	Moment of inertia J 10 ⁻³ kgm ²	◆ Certificate TUV IT 12 ATEX 068X
MIA 4028	MIA 2CT 71 B 6/8	0,12	900	0,73	2,4	50	0,71	1,3	1,4	7,2	T4	1.0	◆
		0,08	690	0,64	2,2	49	0,61	1,1	1,3				
MIA 4029	MIA 2CT 80 A 6/8	0,15	935	0,88	2,6	50	0,71	1,5	1,5	9,0	T4	2.7	◆
		0,13	690	0,83	2,1	52	0,60	1,9	1,5				
MIA 4030	MIA 2CT 80 B 6/8	0,25	930	1,20	3,2	52	0,72	2,7	1,5	10,8	T4	2.7	◆
		0,15	685	1,02	2,2	49	0,60	2,2	1,4				
MIA 4031	MIA 2CT 90 S 6/8	0,35	910	1,55	3,8	55	0,74	3,6	1,4	14,4	T4	3.4	◆
		0,25	650	1,20	3,1	60	0,60	3,8	2,5				
MIA 4032	MIA 2CT 90 L 6/8	0,60	935	2,20	3,8	60	0,76	6,1	1,5	16,2	T4	4.9	◆
		0,30	685	1,55	3,4	61	0,60	4,3	1,6				
MIA 4033	MIA 2CT 100 LA 6/8	0,80	920	2,85	4,0	65	0,77	8,2	1,5	20,7	T4	8.8	◆
		0,55	700	2,40	3,6	68	0,63	7,4	1,6				
MIA 4034	MIA 2CT 100 LB 6/8	1,00	930	3,40	4,1	67	0,75	10,5	1,6	22,5	T4	8.8	◆
		0,65	700	2,70	3,7	68	0,66	8,8	1,6				
MIA 4035	MIA 2CT 112 M 6/8	1,50	960	4,70	4,0	75	0,72	15	1,7	31,5	T4	17.2	◆
		1,00	710	3,80	3,9	65	0,70	13,4	1,6				
MIA 4052	MIA 2CT 132 S 6/8	1,85	960	6,20	4,1	74	0,71	18,4	1,6	54,0	T4	32.3	◆
		1,30	720	5,10	4,0	68	0,65	17,5	1,8				
MIA 4053	MIA 2CT 132 MB 6/8	2,55	965	7,90	4,2	74	0,73	25,1	1,8	59,4	T4	39.5	◆
		1,85	720	6,90	4,1	69	0,67	24,6	1,8				
MIA 4054	MIA 2CT 132 L 6/8	3,00	980	8,30	4,2	80	0,75	29,5	1,8	63,9	T4	50.6	◆
		2,00	735	6,90	4,1	74	0,65	26,3	1,9				
MIA 4055	MIA 2CT 160 M 6/8	4,00	980	10,40	4,3	82	0,75	39,3	1,9	95,4	T4	91.9	◆
		2,80	725	8,50	4,2	78	0,70	37,2	1,9				
MIA 4056	MIA 2CT 160 L 6/8	5,50	985	13,90	4,3	84	0,74	53,5	1,9	106,2	T4	12.18	◆
		4,00	730	10,90	4,2	78	0,75	53,0	1,9				

- ◆ Certificate TUV IT12 ATEX 068X FOR MOTORS Ex e
- ◆ Certificate TUV IT12 ATEX 069X FOR MOTORS Ex nA



6.4 Three-phase Motors 2 Speed – Quadratic Torque (For centrifugal machines)

- Three phase asynchronous motor, squirrel cage rotor, self ventilated (IC411).
- Duty S1, Insulation class "F", IP55, 400V- 50 Hz.

- Connections

Poles	Connections	High Speed	Low Speed
2/4 – 4/8	(Dahlander)	YY 400 V	Y 400V
4/6 – 6/8	(2 Separate windings)	Y 400 V	Y 400V

2 Speed 3000/1500

QUADRATIC TORQUE – Rated data at 400V/50Hz

Ex e /Ex Na(cert. 069X)
Tamb -40 °C/+60 °C

Part number	Type	P kW	rpm min ⁻¹	I _n 400 V Amp.	I _a /I _n	η %	Cos φ	M _n Nm	M _a /M	m Kg	Class T	Moment of inertia J 10 ⁻³ kgm ²	◆ Certificate TUV IT 12 ATEX 068X
MIA 6001	MIA 2QT 63 B 2/4	0,25	2780	1,10	3,3	52	0,70	0,9	2,0	6,3	T4	0.1	◆
		0,06	1410	0,4	2,5	58	0,68	0,4	1,7				
MIA 6002	MIA 2QT 71 A 2/4	0,37	2790	1,30	3,5	59	0,80	1,3	1,8	6,3	T4	0.4	◆
		0,09	1410	0,70	2,8	33	0,70	0,6	1,8				
MIA 6003	MIA 2QT 71 B 2/4	0,50	2800	2,10	3,6	60	0,70	1,7	1,8	7,2	T4	0.4	◆
		0,14	1410	0,65	2,9	65	0,70	1,0	1,9				
MIA 6004	MIA 2QT 80 A 2/4	0,75	2800	2,46	4	63	0,76	2,6	1,8	9,9	T4	0.6	◆
		0,18	1415	0,70	3,5	66	0,79	1,2	2,2				
MIA 6005	MIA 2QT 80 B 2/4	1,10	2810	3,20	4,1	66	0,81	3,7	1,8	11,7	T4	0.8	◆
		0,25	1415	0,84	3,7	70	0,81	1,7	2,2				
MIA 6006	MIA 2QT 90 S 2/4	1,50	2820	4,20	4,5	66	0,82	5,1	2,0	15,75	T4	1.2	◆
		0,37	1420	1,20	3,9	64	0,81	2,5	2,2				
MIA 6007	MIA 2QT 90 L 2/4	2,20	2860	5,20	4,4	70	0,89	7,5	1,9	17,1	T4	1.5	◆
		0,55	1400	1,50	4,4	67	0,87	3,7	2,1				
MIA 6008	MIA 2QT 100 LA 2/4	2,60	2820	5,80	5,6	77	0,92	8,8	2,1	22,5	T4	2.9	◆
		0,62	1420	1,92	5,3	73	0,89	4,2	2,0				
MIA 6009	MIA 2QT 100 LB 2/4	3,30	2800	7,14	5,6	78	0,92	11,3	2,1	24,3	T4	2.9	◆
		0,75	1415	2,10	5	73	0,90	5,1	2,0				
MIA 6010	MIA 2QT 112 M 2/4	4,40	2890	9,00	5,4	76	0,95	14,6	2,0	31,5	T4	7.4	◆
		1,10	1440	2,80	5	76	0,90	7,4	1,9				
MIA 6035	MIA 2QT 132 S 2/4	6,50	2900	13,40	6,1	84	0,92	21,4	2,2	54	T4	15.0	◆
		2,00	1450	5,70	5,9	75	0,81	13,1	2,1				
MIA 6036	MIA 2QT 132 M 2/4	8,50	2910	16,90	6,7	92	0,83	28,1	2,3	59,4	T4	17.8	◆
		2,50	1450	5,90	6,4	90	0,80	16,4	2,3				
MIA 6037	MIA 2QT 132 L 2/4	9,20	2900	18,40	6,8	89	0,85	30,5	2,4	63,9	T4	21.6	◆
		2,80	1450	6,60	6,5	86	0,83	18,5	2,3				
MIA 6038	MIA 2QT 160 M 2/4	12,00	2930	26,90	6,1	76	0,90	39,0	3,5	94,5	T4	36.0	◆
		3,00	1450	8,90	4,3	69	0,82	19,6	2,2				
MIA 6039	MIA 2QT 160 L 2/4	16,00	2930	29,40	7,3	86	0,94	52,0	2,1	103,5	T4	53.4	◆
		4,40	14760	11,40	6,9	79	0,80	28,5	2,0				

**2 Speed 1500/750****QUADRATIC TORQUE – Rated data at 400V/50Hz****Ex e /Ex Na(cert. 069X)
Tamb -40°C/+60°C**

Part number	Type	P kW	rpm min ⁻¹	I _n 400 V Amp.	I _a /I _n	η %	Cos φ	M _n Nm	M _a /M	m Kg	Class T	Moment of inertia J 10 ⁻³ kgm ²	◆ Certificate TUV IT 12 ATEX 068X
MIA 6011	MIA 2QT 71 A 4/8	0,25	1400	0,89	3,0	70	0,75	1,7	2,2	5,85	T4	0.9	◆
		0,05	700	0,56	2,3	28	0,68	0,7	2,8				
MIA 6012	MIA 2QT 71 B 4/8	0,37	1380	1,30	2,5	59	0,80	2,6	1,2	6,75	T4	0.9	◆
		0,07	680	0,65	1,4	33	0,70	1,1	1,2				
MIA 6013	MIA 2QT 80 A 4/8	0,55	1405	1,63	4,4	75	0,74	3,7	2,2	9	T4	1.3	◆
		0,10	700	0,78	2,0	38	0,66	1,4	2,3				
MIA 6014	MIA 2QT 80 B 4/8	0,75	1410	2,10	4,1	70	0,76	5,1	1,7	10,8	T4	1.3	◆
		0,15	690	0,90	2,4	48	0,66	2,1	1,5				
MIA 6015	MIA 2QT 90 S 4/8	0,90	1415	2,95	4,0	77	0,75	6,1	2,3	14,4	T4	2.0	◆
		0,25	710	1,16	2,9	54	0,70	3,4	2,8				
MIA 6016	MIA 2QT 90 L 4/8	1,20	1420	3,60	4,2	80	0,79	8,1	2,3	15,75	T4	2.6	◆
		0,30	710	1,30	1,3	57	0,70	4,0	3,0				
MIA 6017	MIA 2QT 100 LA 4/8	1,90	1390	4,60	5,0	80	0,80	13,1	3,0	20,7	T4	5.3	◆
		0,45	710	2,10	3,0	61	0,68	6,1	2,0				
MIA 6018	MIA 2QT 100 LB 4/8	2,20	1440	5,40	6,0	84	0,85	14,6	2,5	22,5	T4	5.3	◆
		0,55	720	2,20	3,0	68	0,70	7,3	2,4				
MIA 6019	MIA 2QT 112 M 4/8	3,00	1450	7,10	6,0	83	0,85	19,8	2,6	31,5	T4	10.3	◆
		0,75	720	2,77	3,0	70	0,68	9,9	2,4				
MIA 6040	MIA 2QT 132 S 4/8	4,40	1450	10,20	5,8	85	0,82	29,0	2,2	54	T4	25.0	◆
		1,10	710	4,10	3,5	72	0,73	15,0	1,9				
MIA 6041	MIA 2QT 132 MB 4/8	5,90	1445	12,90	6,2	87	0,84	39,0	2,1	59,4	T4	32.4	◆
		1,50	705	5,33	3,9	79	0,64	20,0	1,8				
MIA 6042	MIA 2QT 132 L 4/8	7,50	1450	15,90	6,7	87	0,84	50,0	2,1	63,9	T4	40.5	◆
		1,85	705	5,90	4,3	80	0,70	25,0	1,9				
MIA 6043	MIA 2QT 160 M 4/8	8,80	1450	19,40	6,8	83	0,84	58,3	2,2	95,4	T4	62.7	◆
		2,50	710	7,00	3,9	82	0,75	32,8	2,9				
MIA 6044	MIA 2QT 160 L 4/8	12,00	1460	24,30	6,8	88	0,85	78,6	2,2	106,2	T4	80.1	◆
		3,20	715	8,48	4,0	83,5	0,74	42,2	2,1				

- ◆ Certificate TUV IT12 ATEX 068X FOR MOTORS Ex e
- ◆ Certificate TUV IT12 ATEX 069X FOR MOTORS Ex nA

**2 Speed 1500/1000****QUADRATIC TORQUE – Rated data at 400V/50Hz****Ex e /Ex Na(cert. 069X)
Tamb -40°C/+60°C**

Part number	Type	P kW	rpm min ⁻¹	I _n 400 V Amp.	I _a /I _n	η %	Cos φ	M _n Nm	M _a /M	m Kg	Class T	Moment of inertia J 10 ⁻³ kgm ²	◆ Certificate TUV IT 12 ATEX 068X
MIA 6020	MIA 2QT 71 B 4/6	0,30	1400	0,95	2,6	71	0,75	2,1	2,0	6,75	T4	0.9	◆
		0,10	900	0,50	1,4	63	0,72	1,4	1,8				
MIA 6021	MIA 2QT 80 A 4/6	0,44	1405	1,40	3,2	59	0,8	3,0	1,5	9	T4	1.3	◆
		0,13	900	0,85	1,7	33	0,7	1,4	1,1				
MIA 6022	MIA 2QT 80 B 4/6	0,59	1405	1,80	3,5	76	0,8	3,9	1,7	10,8	T4	1.3	◆
		0,18	905	0,85	2,3	72	0,75	1,9	1,2				
MIA 6023	MIA 2QT 90 S 4/6	0,90	1400	2,45	4,1	77	0,75	6,1	2,1	14,4	T4	2.0	◆
		0,30	900	1,03	3,1	68	0,76	3,1	1,6				
MIA 6024	MIA 2QT 90 L 4/6	1,15	1420	2,80	4,1	80	0,79	7,5	1,8	15,75	T4	2.6	◆
		0,40	910	1,30	2,9	74	0,74	4,2	1,3				
MIA 6025	MIA 2QT 100 LA 4/6	1,80	1410	3,87	5,1	80	0,83	12,1	2,1	20,7	T4	5.3	◆
		0,60	930	1,64	3,9	80	0,75	6,1	1,8				
MIA 6026	MIA 2QT 100 LB 4/6	2,20	1440	5,40	3,8	82	0,87	15,2	1,7	22,5	T4	5.3	◆
		0,70	940	2,60	3,0	80	0,75	7,5	1,5				
MIA 6027	MIA 2QT 112 M 4/6	3,00	1450	6,80	5,5	84	0,82	19,8	2,0	31,5	T4	10.3	◆
		0,90	940	2,50	4,0	81	0,79	9,1	1,9				
MIA 6045	MIA 2QT 132 S 4/6	4,00	1450	9,40	6,3	84	0,82	26,0	2,1	49,5	T4	25.0	◆
		1,20	945	3,90	4,9	80	0,75	11,8	1,7				
MIA 6046	MIA 2QT 132 MA 4/6	4,80	1460	12,30	6,6	75	0,81	31,2	1,9	54	T4	32.4	◆
		1,40	970	6,00	5,2	69	0,6	14,0	1,9				
MIA 6047	MIA 2QT 132 MB 4/6	5,50	1455	13,80	5,4	77	0,81	36,0	2,1	59,4	T4	32.4	◆
		1,70	960	7,40	4,8	64	0,62	17,0	1,9				
MIA 6048	MIA 2QT 132 L 4/6	6,60	1460	16,30	6,7	89	0,72	43,2	1,9	63,9	T4	40.5	◆
		2,00	950	8,90	5,2	78	0,55	20,1	1,9				
MIA 6049	MIA 2QT 160 M 4/6	7,50	1470	17,40	7,2	81	0,85	49,0	2,2	95,4	T4	62.7	◆
		2,50	985	8,20	5,9	72	0,72	24,2	2,3				
MIA 6050	MIA 2QT 160 L 4/6	11,00	1450	23,80	6,9	84	0,85	72,0	2,2	106,2	T4	80.1	◆
		3,30	960	10,30	6,1	73	0,72	32,0	2,3				

- ◆ Certificate TUV IT12 ATEX 068X FOR MOTORS Ex e
- ◆ Certificate TUV IT12 ATEX 069X FOR MOTORS Ex nA

**2 Speed 1000/750****QUADRATIC TORQUE – Rated data at 400V/50Hz****Ex e /Ex Na(cert. 069X)
Tamb -40°C/+60°C**

Part number	Type	P kW	rpm min ⁻¹	In 400 V Amp.	I _a /I _n	η %	Cos φ	M _n Nm	M _g /M	m Kg	Class T	Moment of inertia J 10 ⁻³ kgm ²	◆ Certificate TUV IT 12 ATEX 068X
MIA 6028	MIA 2QT 80 A 6/8	0,33	920	1,52	3,1	55	0,70	3,4	1,8	9	T4	2.7	◆
		0,09	680	0,60	1,9	57	0,62	1,3	1,4				
MIA 6029	MIA 2QT 80 B 6/8	0,40	935	1,68	2,9	58	0,70	4,0	1,8	10,8	T4	2.7	◆
		0,12	685	0,70	2,1	55	0,63	1,7	1,4				
MIA 6030	MIA 2QT 90 S 6/8	0,48	925	1,98	3,1	61	0,65	4,8	1,9	14,4	T4	3.4	◆
		0,19	690	1,05	2,1	55	0,62	2,7	1,5				
MIA 6031	MIA 2QT 90 L 6/8	0,66	900	3,00	3,2	60	0,80	7,1	2,0	15,75	T4	4.9	◆
		0,25	700	1,40	2,3	52	0,62	3,5	1,7				
MIA 6032	MIA 2QT 100 LA 6/8	0,90	960	3,35	4,1	67	0,68	8,9	1,9	20,7	T4	8.8	◆
		0,37	720	2,25	3,5	50	0,65	4,8	1,8				
MIA 6033	MIA 2QT 100 LB 6/8	1,10	950	3,85	3,9	70	0,70	11,2	1,6	22,5	T4	8.8	◆
		0,45	720	2,60	3,4	52	0,64	5,9	1,4				
MIA 6034	MIA 2QT 112 M 6/8	1,50	970	4,40	4,4	75	0,74	15,1	2,1	31,5	T4	17.2	◆
		0,75	720	3,20	3,5	61	0,68	10,1	1,7				
MIA 6051	MIA 2QT 132 S 6/8	2,20	960	6,60	4,4	75	0,75	22,2	2,2	54	T4	32.3	◆
		0,90	720	4,20	3,7	62	0,66	11,9	1,8				
MIA 6052	MIA 2QT 132 MA 6/8	3,00	970	7,90	4,8	77	0,82	29,7	2,1	59,4	T4	39.5	◆
		1,20	730	5,80	3,8	61	0,63	15,6	1,8				
MIA 6053	MIA 2QT 132 MB 6/8	3,70	970	9,80	5,1	80	0,77	36,5	2,1	63,9	T4	50.6	◆
		1,50	720	5,90	3,8	65	0,70	20,1	2,1				
MIA 6054	MIA 2QT 160 M 6/8	5,50	980	13,30	5,5	88	0,75	53,5	2,2	95,4	T4	91.9	◆
		2,50	730	7,70	4,2	84	0,65	32,5	2,3				
MIA 6055	MIA 2QT 160 L 6/8	7,50	970	15,30	5,7	84	0,85	73,5	2,1	106,2	T4	12.18	◆
		4,00	720	10,10	3,9	81	0,80	53,2	2,1				

- ◆ Certificate TUV IT12 ATEX 068X FOR MOTORS Ex e
- ◆ Certificate TUV IT12 ATEX 069X FOR MOTORS Ex nA

7 OVERALL DIMENSION

7.1 Three phase motors

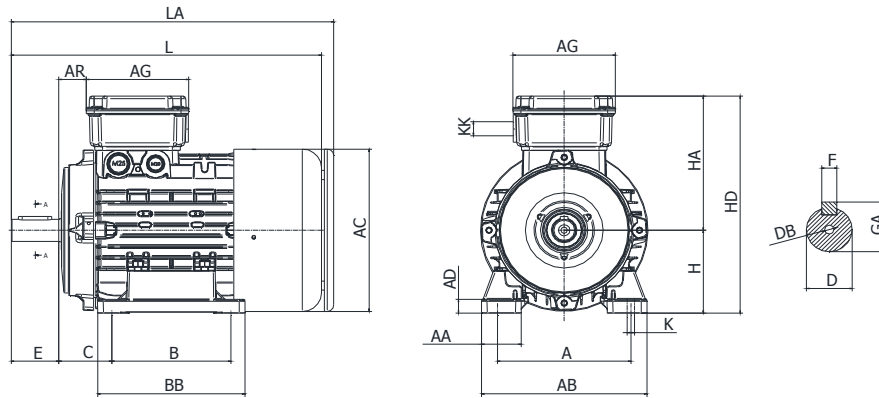

Tipo	Mounting B3													Shaft								
	A	AA	AB	AC	AD	AG	AR	B	BB	C	K	KK	H	HA	HD	L	LA	D	DB	E	F	GA
56	90	21	108	110	10	100	12	71	90	36	6	2xM16	56	104	160	187	L+9	9j6	M3	20	3	10,2
63	100	28	120	124	10	100	12	80	105	40	7	2xM16	63	106	169	214	L+12	11j6	M4	23	4	12,5
71	112	30	137	138	12	100	18	90	110	45	7	2xM16	71	119	190	240	L+12	14j6	M5	30	5	16
80	125	32	154	156	13	108	26	100	125	50	9	M20-M25	80	142	222	275	L+11	19j6	M6	40	6	21,5
90S	140	42	178	176	15	108	29	100	130	56	9	M20-M25	90	146	236	304	L+15	24j6	M8	50	8	27
90L	140	42	178	176	15	108	29	125	155	56	9	M20-M25	90	146	236	325	L+15	24j6	M8	50	8	27
100	160	37	192	194	16	108	36	140	175	63	12	M20-M25	100	157	257	368	L+12	28j6	M10	60	8	31
112	190	40	224	218	16	108	38	140	176	70	12	M20-M25	112	167	279	385	L+11	28j6	M10	60	8	31
132S	216	58	258	258	18	121	46	140	180	89	12	2xM32	132	191	323	455	L+15	38k6	M12	80	10	41
132M	216	58	258	258	18	121	46	178	218	89	12	2xM32	132	191	323	495	L+15	38k6	M12	80	10	41
160M	254	72	318	310	22	186	50	210	264	108	14	2xM32	160	245	405	598	L+20	42k6	M16	110	12	45
160L	254	72	318	310	23	186	50	254	306	108	14	2xM32	160	245	405	641	L+20	42k6	M16	110	12	45

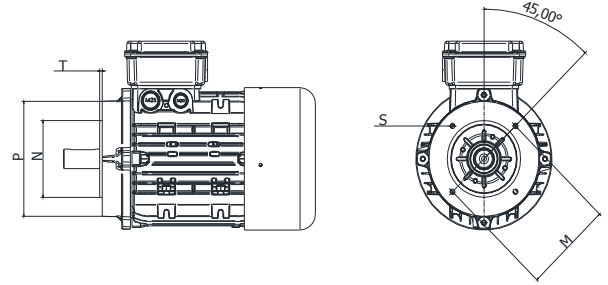
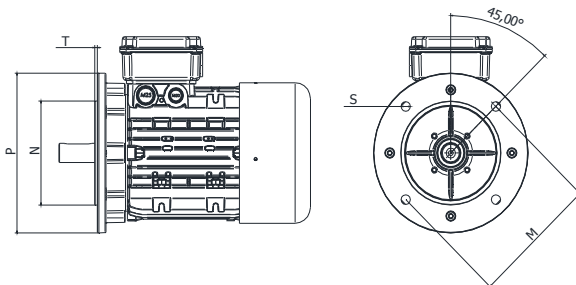

Mounting B5					
8 fori - 45°					
Tipo	P	N	M	S	T
56	120	80j6	100	7	3
63	140	95j6	115	9	3
71	160	110j6	130	10	3,5
80	200	130j6	165	12	3,5
90S	200	130j6	165	12	3,5
90L	200	130j6	165	12	3,5
100	250	180j6	215	15	4
112	250	180j6	215	15	4
132S	300	230j6	265	15	4
132M	300	230j6	265	15	4
160M	350	250h6	300	18	5
160L	350	250h6	300	18	5

Mounting B14					
8 fori - 45°					
Tipo	P	N	M	S	T
56	80	50j6	65	M4	2,5
63	90	60j6	75	M5	2,5
71	105	70j6	85	M6	2,5
80	120	80j6	100	M6	3
90S	140	95j6	115	M8	3
90L	140	95j6	115	M8	3
100	160	110j6	130	M8	3,5
112	160	110j6	130	M8	3,5
132S	200	130j6	165	M10	3,5
132M	200	130j6	165	M10	3,5
160M	250	180h6	215	M12	4
160L	250	180h6	215	M12	4

8 SPARE PARTS

8.1 Personnel qualification

Overhauls and repairs must be only realised by qualified people in accordance with the standards EN 60079-17 or national standards (last edition). Qualified people must have knowledge about explosion protection. Repairs must be made regarding the rules as define in EN 60079-19 standards. These repairs can only be done under the control or agreement with RAELE Motori Elettrici by a repair shop designed by RAELE or a recognized laboratory. In case these rules are not respected, RAELE liability is released.

8.2 List of spare parts

All motors components must be replaced by original spare parts. In these cases please contact RAELE directly and give the serial number of the motor so to ask the authorization to repair the motor too.

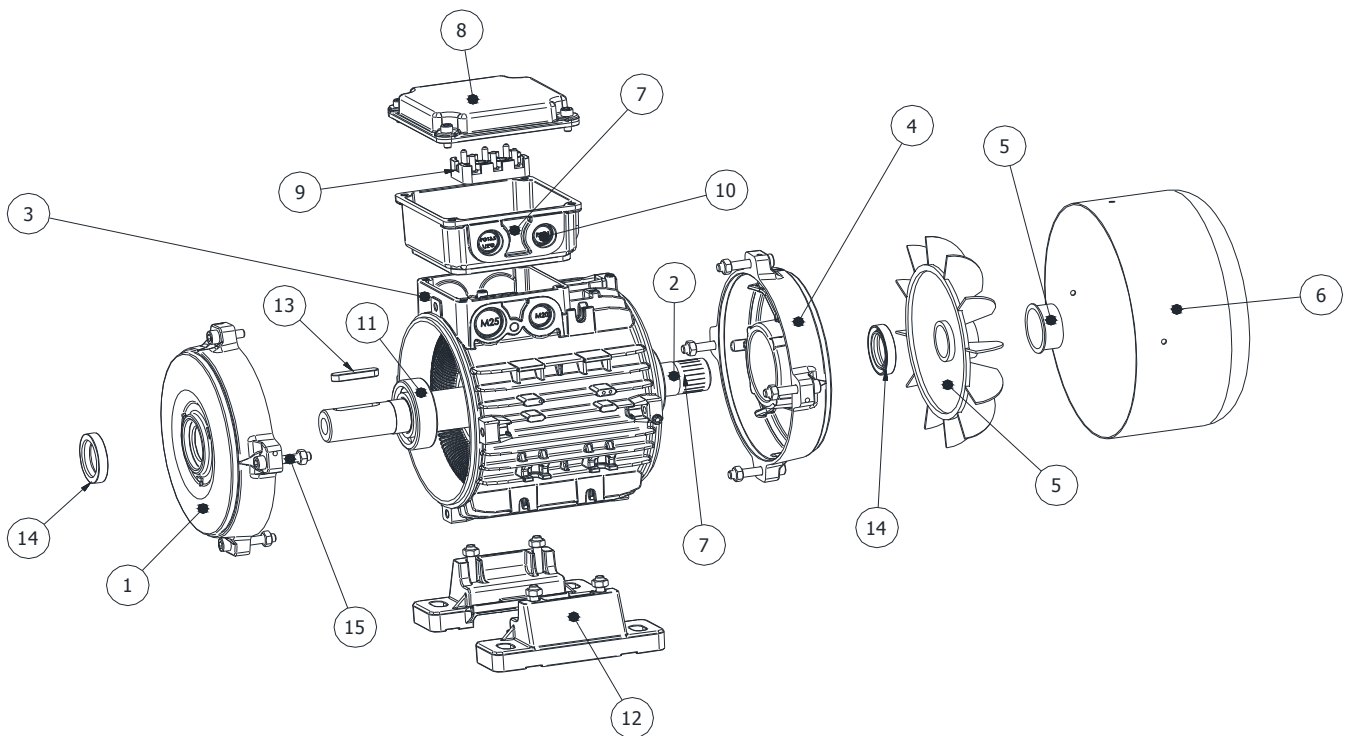

1	DRIVE END SHIELD	6	FAN COVER	11	BALL BEARINGS
2	SHAFT WITH ROTOR	7	TERMINAL BOX	12	MOTOR FEET
3	FRAME	8	TERMINAL BOX COVER	13	FLANGE B14 (or B5)
4	NO-DRIVE END SHIELD	9	TERMINAL BLOCK	14	ABY ANGULAR BEARING
5	COOLING FAN	10	CABLE GLAND	15	TIE RODS (quality 4.8)

